

# RUSKIN

## USER GUIDE

RBR *virtuoso*<sup>3</sup>

RBR *concerto*<sup>3</sup>

RBR *brevio*<sup>3</sup>

RBR *duo*<sup>3</sup>

RBR *maestro*<sup>3</sup>

RBR *quartz*<sup>3</sup>



[rbr-global.com](http://rbr-global.com)

# Table of contents

<b>1</b>	<b>Ruskin software</b> .....	<b>6</b>
<b>2</b>	<b>Ruskin interface</b> .....	<b>7</b>
2.1	Ruskin / Options.....	9
2.2	File.....	10
2.3	Instruments .....	10
2.4	Help.....	10
<b>3</b>	<b>Installation</b> .....	<b>11</b>
3.1	Install Ruskin on a PC.....	11
3.2	Install Ruskin on a Mac .....	12
3.3	Update Ruskin .....	13
3.4	Uninstall Ruskin .....	13
<b>4</b>	<b>Support</b> .....	<b>14</b>
4.1	Search on Mac .....	15
4.2	Release notes .....	16
4.3	Documentation .....	17
4.4	Comment on Ruskin.....	17
4.5	Check for updates .....	18
4.6	Feature codes.....	19
<b>5</b>	<b>Quick start - Ruskin Desktop</b> .....	<b>20</b>
5.1	Select Desktop on Ruskin .....	20
5.2	Simulate an instrument.....	21
5.3	Deploy your instrument.....	23
5.4	Recover your instrument and download data.....	24

<b>6</b>	<b>Quick start - Ruskin Mobile .....</b>	<b>26</b>
6.1	Select Mobile on Ruskin.....	27
6.2	Connect to your instrument .....	28
6.3	Deploy your instrument.....	31
6.4	Access datasets and charts.....	35
6.5	Track your instrument .....	40
6.6	Adjust your settings .....	44
<b>7</b>	<b>Connections .....</b>	<b>46</b>
<b>8</b>	<b>Configuration .....</b>	<b>48</b>
8.1	Update firmware .....	48
8.2	Schedule.....	49
8.3	Power.....	51
8.4	Sampling.....	54
8.4.1	Average .....	56
8.4.2	Burst.....	57
8.4.3	Directional .....	58
8.4.4	Tide .....	60
8.4.5	Wave .....	61
8.5	Gating .....	64
8.6	Options .....	67
8.7	Voltage sensors .....	69
8.8	Ranging sensors .....	70
8.9	Valve control.....	71
8.10	Download .....	72
8.11	Use auto-deploy settings.....	75
8.12	Enable / Stop .....	76
<b>9</b>	<b>Information.....</b>	<b>78</b>

<b>10</b>	<b>Calibration .....</b>	<b>79</b>
<b>11</b>	<b>Parameters .....</b>	<b>82</b>
<b>12</b>	<b>Preferences .....</b>	<b>83</b>
12.1	Derived channels.....	83
12.2	General .....	88
12.3	Plotting.....	91
<b>13</b>	<b>RSK files.....</b>	<b>93</b>
<b>14</b>	<b>Realtime data format .....</b>	<b>94</b>
<b>15</b>	<b>Datasets.....</b>	<b>95</b>
15.1	Open dataset.....	96
15.2	Export .....	98
15.3	Analysis.....	99
15.4	Overview.....	102
15.5	Channels.....	102
15.6	File info .....	107
<b>16</b>	<b>Plot window .....</b>	<b>108</b>
<b>17</b>	<b>Dataset plot toolbar .....</b>	<b>110</b>
17.1	Annotation controls.....	110
17.1.1	Select annotation type .....	110
17.1.2	Navigate between annotations .....	111
17.1.3	Create new annotation .....	112
17.1.4	Add profiles .....	114
17.1.5	Export region.....	116
17.2	Cast detection .....	118
17.3	Event visibility .....	118
17.4	Zoom controls.....	119
17.4.1	Horizontal zoom.....	119

17.4.2	Vertical zoom.....	121
17.4.3	Navigation options.....	123
17.4.4	Advanced axis controls .....	125
17.5	Export plot.....	127
17.6	Appearance controls.....	127
17.7	GPS map .....	129
<b>18</b>	<b>Live data plot toolbar .....</b>	<b>130</b>
<b>19</b>	<b>Firmware updates.....</b>	<b>133</b>
19.1	Critical firmware updates .....	133
19.2	Routine firmware updates .....	134
19.3	Manual firmware updates.....	136
<b>20</b>	<b>Automatic tasks.....</b>	<b>138</b>
<b>21</b>	<b>Utilities.....</b>	<b>141</b>
<b>22</b>	<b>User calibration .....</b>	<b>144</b>
22.1	Dissolved oxygen sensor calibration.....	144
22.1.1	Dissolved oxygen data collection.....	145
22.1.2	DO calibration in Analysis tab .....	147
22.1.3	ODO calibration in Plot window .....	151
22.2	Turbidity sensor calibration .....	156
22.2.1	Tu data collection .....	156
22.2.2	Tu calibration in Analysis tab .....	158
22.3	pH sensor calibration.....	162
22.3.1	pH data collection.....	162
22.3.2	pH calibration in Analysis tab.....	164
22.4	Fluorometer calibration .....	167
22.4.1	Fluorescence data collection .....	167
22.4.2	Chlorophyll a calibration in Analysis tab .....	169
<b>23</b>	<b>Revision history.....</b>	<b>173</b>

# 1 Ruskin software

Ruskin is the only tool you need to manage all your RBR instruments and measurement data. It is available for Mac and Windows PC (Ruskin Desktop), as well as for iOS® and Android™ (Ruskin Mobile).

Use the Ruskin software to do the following:

- Configure, schedule, and enable multiple instruments
- Estimate your deployment times
- Download your data after logging
- View your datasets graphically
- Export your data in various formats
- Analyse your data
- Change the calibration coefficients for your instrument
- Perform user calibration
- Contact RBR

RSK files generated by Ruskin contain contain raw measurement data, firmware and software versions, dates and times, sampling settings, power settings, measured and derived parameters, errors and events, other diagnostic information. They can be read directly in Matlab, or exported to Excel, OceanDataView®, or text files.

Find Ruskin software for Mac and PC on the USB stick included with your instrument, or visit the [RBR website](#) to download the latest version.

Go to the Apple App store or Google Play for [Quick start - Ruskin Mobile](#).

The most recent software updates, release notes, Ruskin user guides, instrument guides, and quick start guides are available from the **Help** menu in Ruskin.

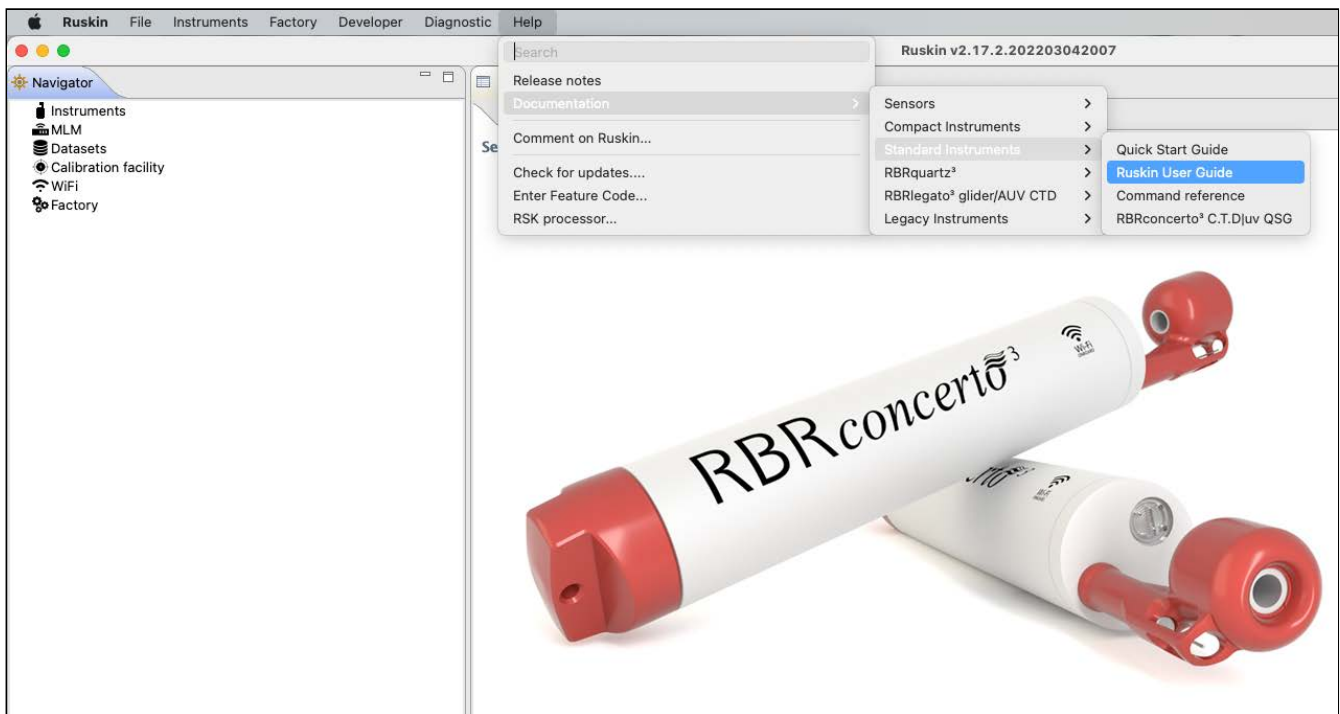

## 2 Ruskin interface

Ruskin software has a user-friendly interface which consists of a **Toolbar** and three main windows: **Navigator**, **Properties**, and **Plot**.

### Toolbar

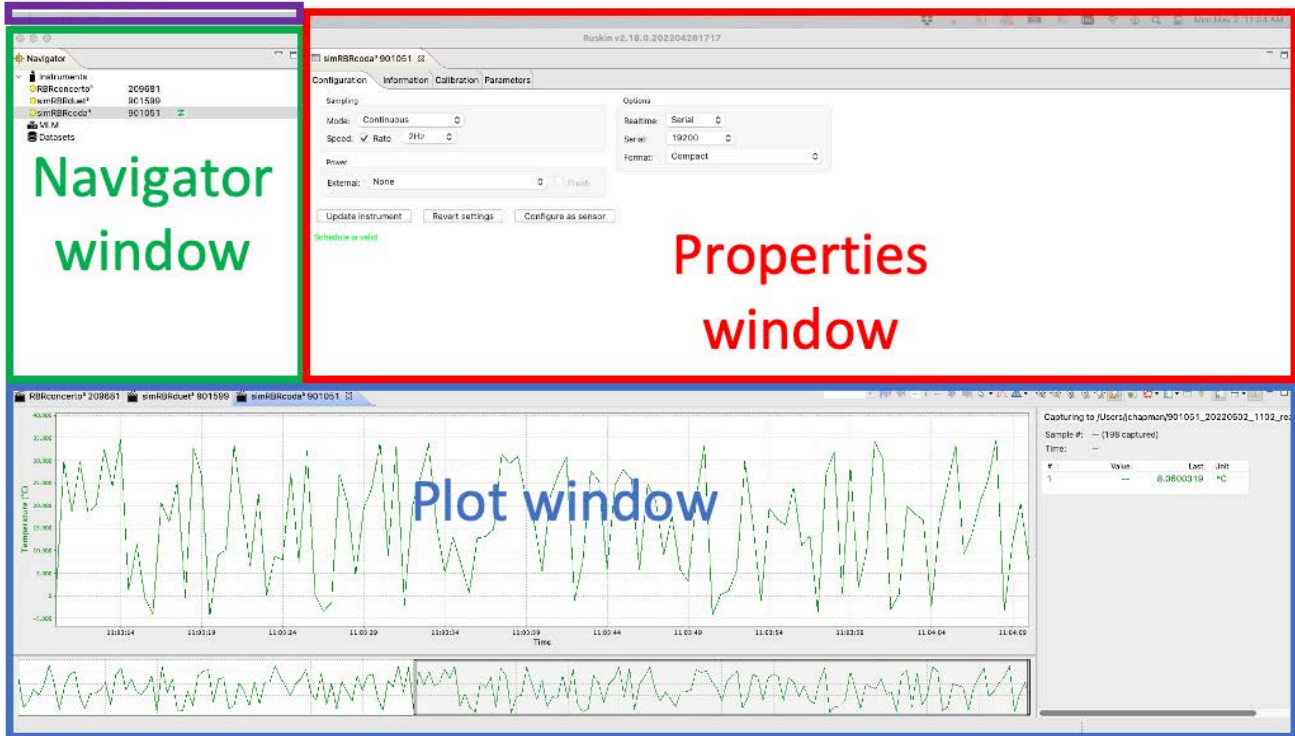





In the **Navigator** window, you will find the list of instruments connected to Ruskin, as well as MLM (if applicable) and [datasets](#).

When an instrument on the list is selected, the **Properties** window displays four tabs with information related to this instrument: [Configuration](#), [Information](#), [Calibration](#), and [Parameters](#). Use these tabs to configure your deployment, check the calibration certificates, and verify your parameters.

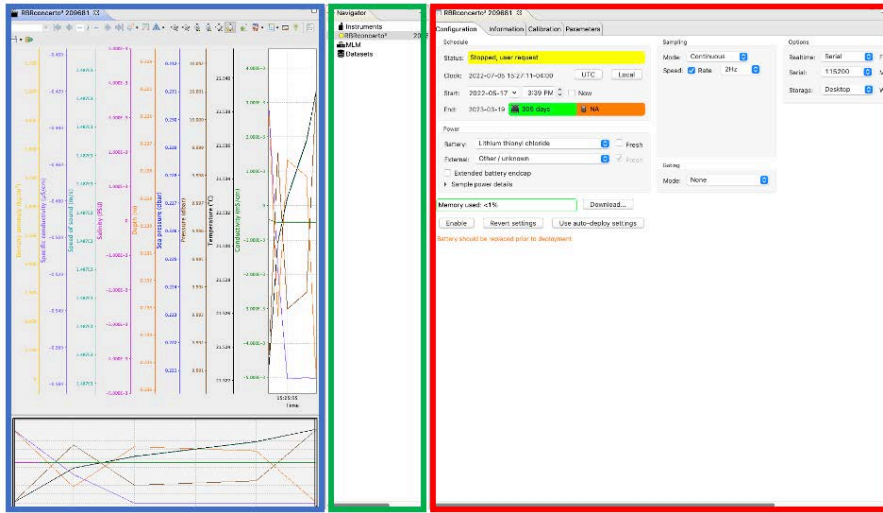

The data plot will appear in the [Plot window](#) below if the realtime option is available and selected for this instrument, or if you click the **Fetch** button  on the far right of the toolbar.

Click-and-drag window tabs to rearrange the windows within Ruskin, or move a window outside of Ruskin. Hover over a side of a window, and when the cursor becomes a two-way arrow , move it to adjust the window size.

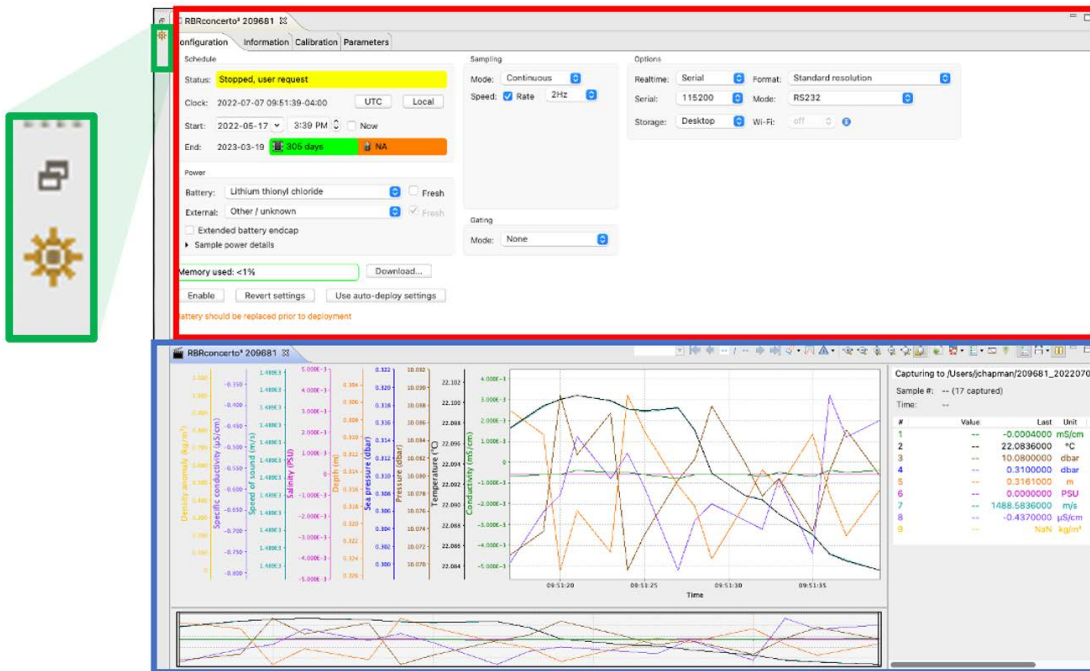

Click the **Close**  button in the top right corner to close a window. For example, you can close the **Navigator** window to have a better view of the **Properties**. The closed window icon will appear on the sidebar (in this case, **Navigator** ). Click the **Multiple windows**  button above the closed window icon to re-open it.



Double-click a window tab to maximise that window, and double-click the tab again to return it to the original size. Alternatively, use the **Single window**  and **Multiple windows**  buttons.



 When you restart Ruskin, it returns to its original layout.

The **Toolbar** at the top left above the **Navigator** window has four dropdown menus. If you are using a Mac computer, it appears as follows:



On a Windows PC, the **Toolbar** looks slightly differently:



The rest of the interface is the same between the two systems.

## 2.1 Ruskin / Options

On your Mac, go to the **Ruskin** dropdown menu to access information on current software version, set up your [preferences](#), or quit Ruskin. Note that the rest of the options on this dropdown menu depend on your operating system and are external to Ruskin.

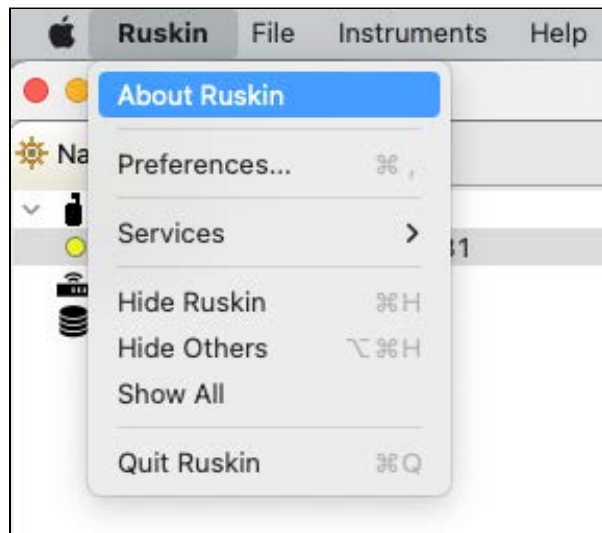

On your Windows PC, use the **Options** dropdown menu to set up your [preferences](#).

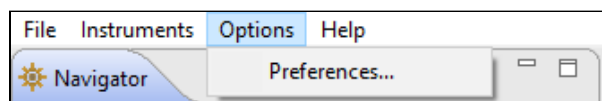

## 2.2 File

Go to the **File** dropdown menu to open or close a dataset, export your data, and see the list of available datasets. The **Datasets** menu in the **Navigator** windows duplicates some of these options for convenience.

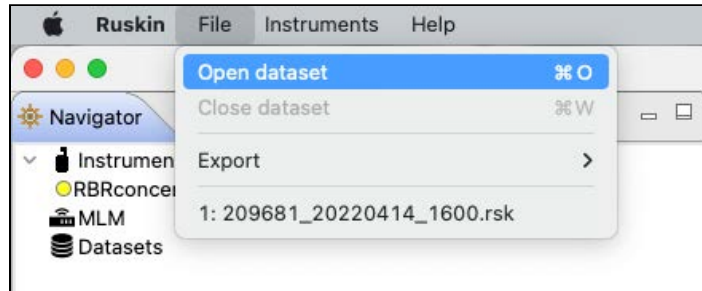

## 2.3 Instruments

Go to the **Instruments** dropdown menu to [simulate an instrument](#), [update your firmware](#), set up [automatic tasks](#), or take advantage of the utilities.

 The **Utilities** option is a support tool. Contact [RBR](#) before using it.

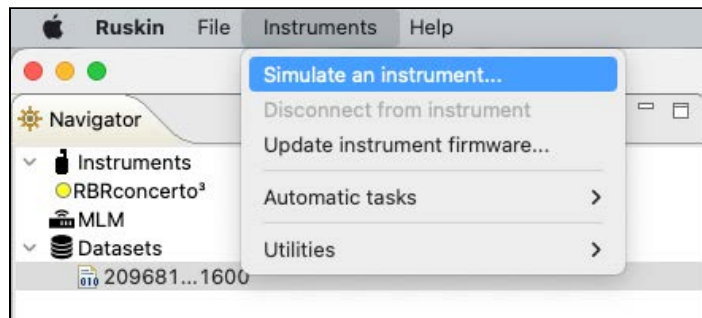

The **Instruments** menu in the **Navigator** windows duplicates some of these options for convenience.

## 2.4 Help

Go to the **Help** dropdown menu to access the latest [release notes](#) and technical [documentation](#), [provide your feedback](#), [check for updates](#), or to add a beta [feature](#). On Mac, you can also use the [Search](#) option.

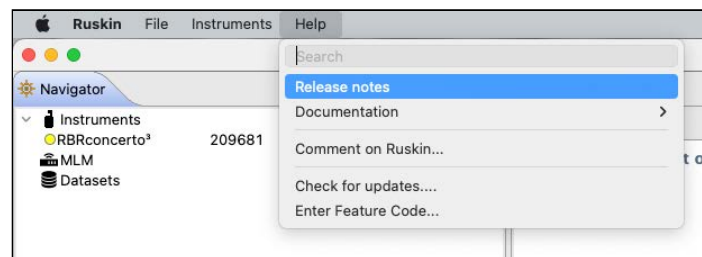

## 3 Installation

Ruskin is the only piece of software you need to operate your RBR instruments. RBR releases Ruskin software versions compatible with Mac and PC (Ruskin Desktop), as well as with iOS® and Android™ (Ruskin Mobile).

Install the Ruskin Mobile app on your mobile device by going to the Apple App store or Google Play.

Follow the steps below to install Ruskin Desktop on your computer.

### 3.1 Install Ruskin on a PC

You can install Ruskin on a PC that runs the Windows 7, 8, 8.1, or 10 operating system.

The minimum requirements for Ruskin are:

- OS = Windows 7
- Processor speed = 1.4GHz
- RAM required = 2GB
- Display resolution = 1024x768 recommended
- HDD space for installation = 500MB

The instruments use a USB interface to communicate with Ruskin.

#### Steps

1. Connect the USB stick included with your instrument to a port on your computer.
2. Navigate to the "Ruskin Installation" folder and doubleclick on the file `RuskinSetup.exe`.
3. Follow the installation wizard. By default, Ruskin will be installed to `C:\RBR`.
4. At the end of the installation, you will see a prompt asking, "Would you like to install the logger driver at this time?"
5. Click **Yes** to install the drivers.

 You may need to run the setup application as an administrator to install the driver correctly.

A shortcut to Ruskin will appear on the desktop and in a **Start** menu folder.

 The most recent version of Ruskin software can be found at <https://rbr-global.com/products/software>.

## 3.2 Install Ruskin on a Mac

You can install Ruskin on a Mac running OS X 10.12 (Sierra) or later.

### Steps

1. Connect the USB stick included with your instrument to a port on your adaptor.
2. Navigate to the "OSX" folder and double-click on the file `Ruskin.dmg`.
3. When the disk image window opens, drag the Ruskin icon into the **Applications** directory and wait for the copy to complete. An application named "Ruskin" will appear in the **Applications** folder.

 Always use the default **Applications** folder as the working directory.

4. Right-click on the icon, and select **Open**.
5. The dialogue box shown below will prompt you to authorise the opening of Ruskin.

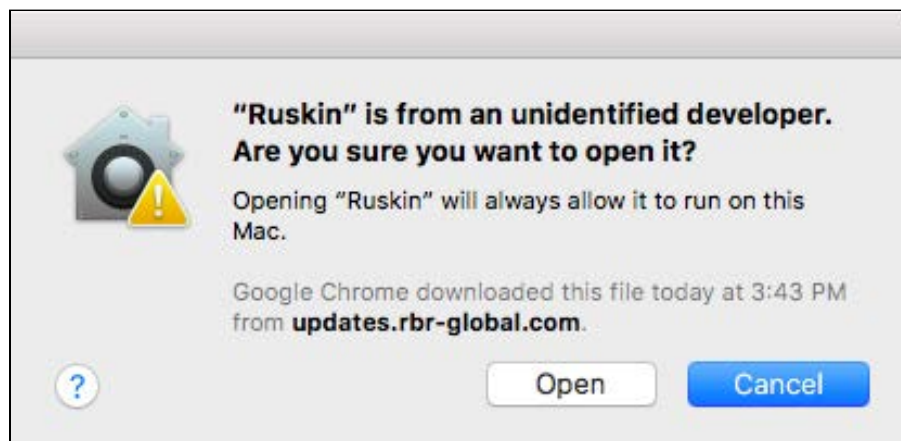

 You may need to navigate to **System Preferences > Security & privacy** to allow the apps downloaded from "**Anywhere**" to complete the installation.

6. Drag the `Ruskin.app` application to the **Dock**.

## 3.3 Update Ruskin

To take advantage of new features and bug fixes, ensure that you are using the most recent version of Ruskin.

- Find the most recent version of Ruskin at <https://rbr-global.com/products/software>.
- Receive an automatic notification about a new release when you start the application.
- Check from within Ruskin by navigating to **Help > Check for updates**.
- Send an email to [support@rbr-global.com](mailto:support@rbr-global.com), subject: "Ruskin update request", and ask us to add you to the mailing list. You will receive an email as soon as the new version is released.

If you have a broadband connection, simply follow the installation instructions on your computer. Otherwise, request a USB stick from RBR.

 It is not necessary to uninstall the older version of Ruskin before installing the newer version. The installation program deletes the older files before installing the newer ones. It does not delete any Ruskin data files or log files.

## 3.4 Uninstall Ruskin

Uninstall Ruskin only if you no longer need to manage RBR instruments from your computer.

It is not necessary to uninstall the older version of Ruskin before installing the newer version. The installation program deletes the older files before installing the newer ones. For more information, see [Update Ruskin](#).

 Removing Ruskin will not delete your data files or your diagnostic logs.

### Uninstall Ruskin on a PC, Windows 7, 8, 8.1, or 10

1. Go to **Start > Control Panel > Programs**.
2. Under **Programs and Features**, click **Uninstall a program**.
3. Find **Ruskin** on the list.
4. Click **Ruskin** to highlight it.
5. Click **Uninstall**.

### Uninstall Ruskin on a Mac, OS X 10.12 or later

Move the Ruskin application from **Applications** to the **Trash**.

## 4 Support

You can get in touch with RBR in several different ways:

- Send us an email. For technical questions, use [support@rbr-global.com](mailto:support@rbr-global.com), and for general inquiries, [info@rbr-global.com](mailto:info@rbr-global.com).
- Contact us via the website at <https://rbr-global.com/about-rbr/contact-rbr>.
- Call us at +1 (613) 599-8900.
- Send us a bug report from within Ruskin itself.

 When experiencing an issue, look for a solution under the **Help** menu before contacting RBR.

The **Help** menu on Ruskin offers access to technical documentation, feedback forms, and software updates. On Mac, you can also search for Ruskin menu options.

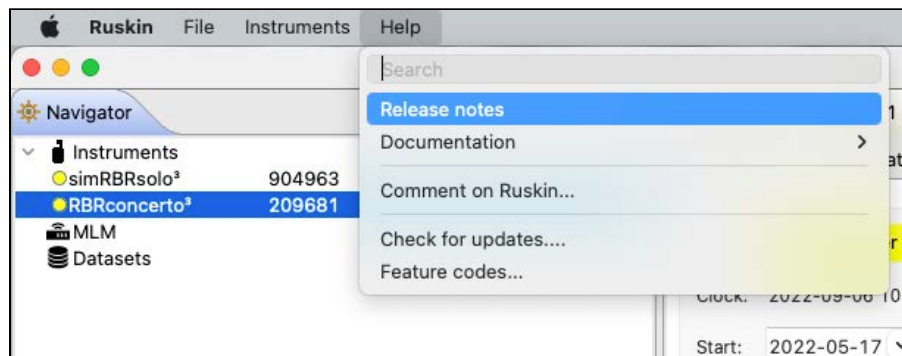

## 4.1 Search on Mac

If using a Mac computer, you can take advantage of the **Search** option.

In the **Search** field under **Help**, type in a word, part of the word, or even a single letter to open a list of matching items.

The top half of the list pertains to Ruskin, while the bottom part comes from the Mac environment.

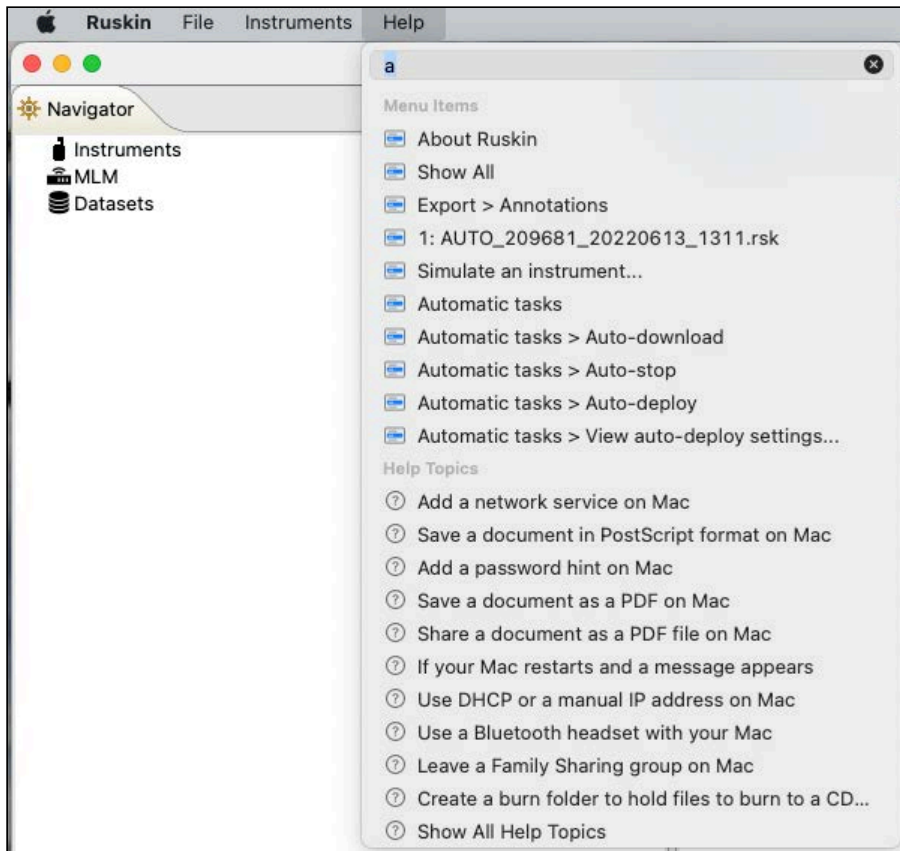

Scroll down the Ruskin list and select an item to locate. Ruskin will open the toolbar menu and point to the option in the dropdown menu.

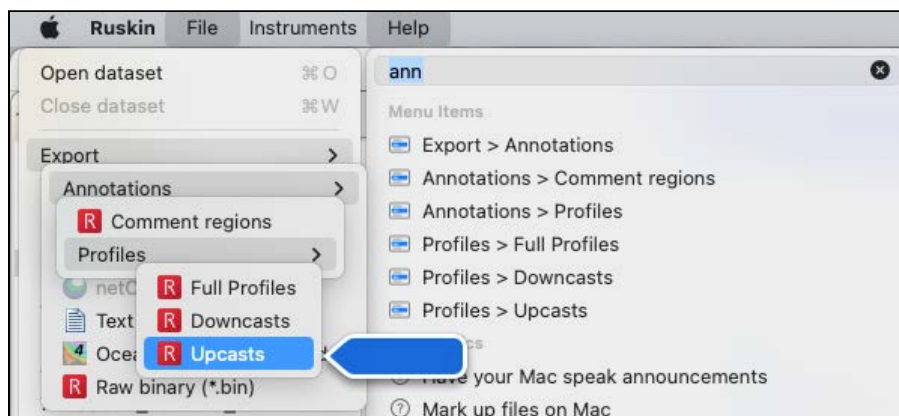

You can execute the located option right away.

## 4.2 Release notes

Click on **Help > Release notes** to open the **Welcome** window. It will outline new features, improvements, and bug fixes associated with each release version.

**Release Notes**

### 2.19.1

**Release date:** October 21 2022

#### Bug fixes

- RSK-9274 - Unable to enable instrument in local time when the clock has a positive UTC offset

### 2.19.0

**Release date:** October 04 2022

#### New Features

##### RBRtridente

RBR's new RBRtridente multi-channel optical sensor is now fully integrated into Ruskin. Connect your sensor to change its sampling speed and record data in real-time.

#### Did you know?

You can simulate a sensor even if you don't yet have one. Ruskin lets you simulate the RBRtridente as a standalone sensor or as part of a larger integration. We've updated Ruskin's autonomy engine to let you easily plan deployments using this tool too.

#### Other notable additions

- Added RBR Instrument Guide (RIG) for RBRquartz<sup>3</sup> APT and Standard instruments
- Added Quick Start Guide (QSG) for RBRquartz<sup>3</sup> APT
- Updated Quick Start Guide (QSG) for RBRfermata
- Updated Ruskin User Guide (RUG) for RBRcoda<sup>2</sup>, Compact instruments, and Standard instruments

#### Improvements

- RSK-6356 - Added link to release notes to get full history
- RSK-7886 - Added copy/paste functionality to RBRquartz<sup>3</sup> calibration coefficient tables
- RSK-8672 - Added channel indices to RSK analysis data table
- RSK-8703 - Removed column auto-sizing on Excel exports
- RSK-8756 - Release notes window was renamed from 'Welcome' to 'Release notes'
- RSK-8762 - Added dialog to view all user activated feature codes

[Click here to see all Release Notes](#)

**Did you know...**

#### Ruskin Updates

Ruskin can automatically notify you that a newer version is available.

If you do not have a broadband connection and/or are unable to install the Ruskin updates, update notifications are available via email. To receive these notifications, send an email to: [support@rbr-global.com](mailto:support@rbr-global.com) subject: "Ruskin update request".

#### Let us know!

If you have problems or praise, please let us know. Either use the "Help/Comment on Ruskin" menu item or write to [support@rbr-global.com](mailto:support@rbr-global.com).

Previous Next

**THREE OR FREE**

Calibration in three weeks or less. Guaranteed.

Click the calibration tab and select "request a calibration quote" to get started.

Click the link at the bottom left to see the full history of the release notes. The link will take you to the [RBR support](#) page.

Alternatively, scroll down to see brief recaps of the release notes from all previous versions.

Click the **x** to close the **Release notes** window and return to the **Navigator** mode.



## 4.3 Documentation

Click on **Help > Documentation** to open the menu tree. Browse through a variety of guides available for instruments and accessories.

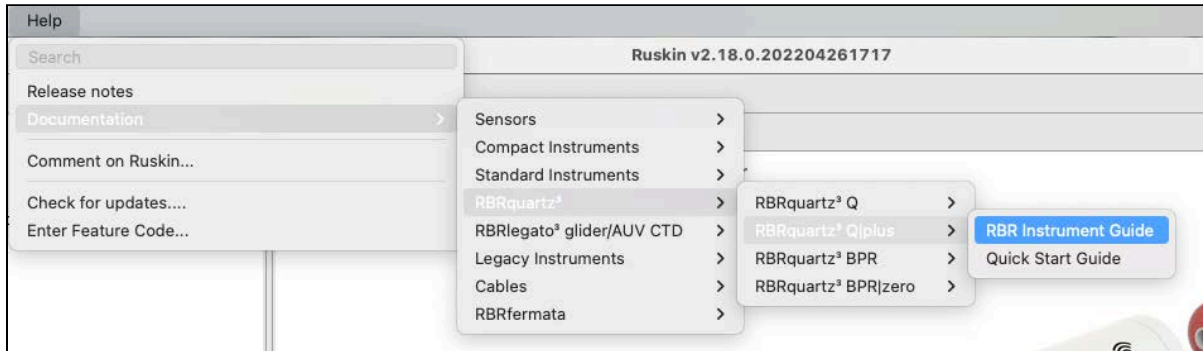

Please note that you can always access the most current revisions of RBR documents on the [RBR website](https://www.rbr-global.com/support/documentation/).

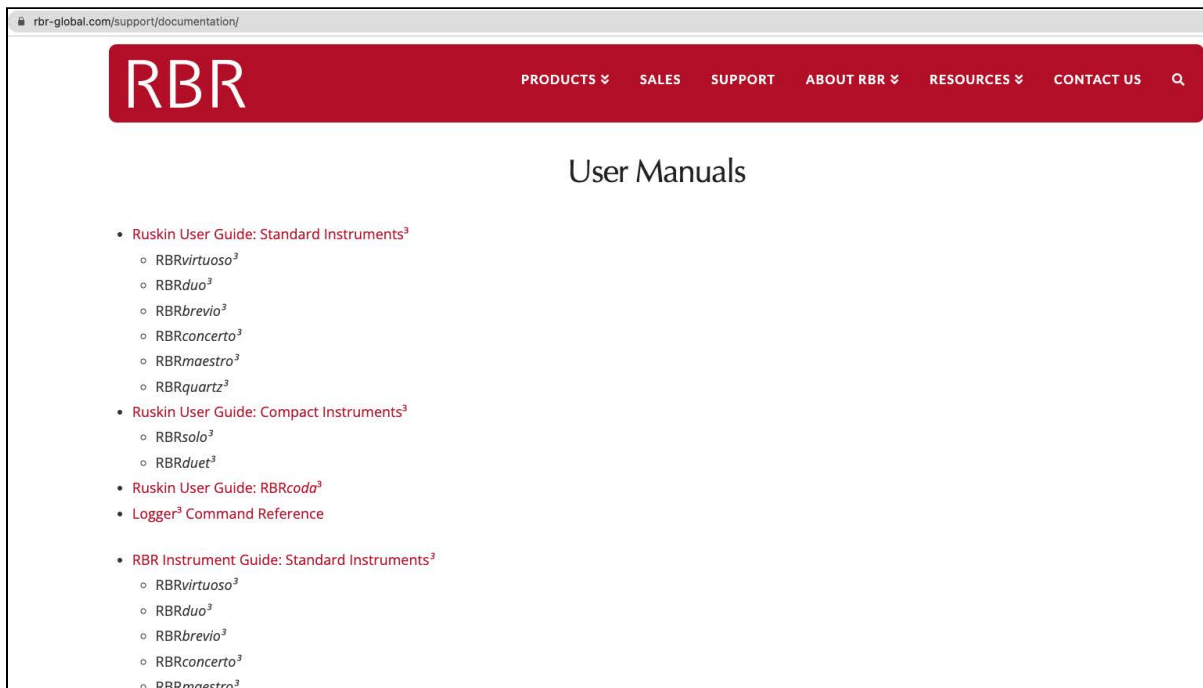

## 4.4 Comment on Ruskin

There is an advantage to sending a bug report from within Ruskin because this allows you to include the diagnostic logs, RSK datasets, screenshots, and any other files that could help us reproduce the problem and find the solution as quickly as possible. Follow the steps below.

## Steps

1. Click on **Help > Comment on Ruskin...** . The **Feedback to RBR** form will appear.
2. Enter your identification information.
3. Enter a brief summary of the problem.
4. Provide a detailed description (serial number for the instrument, overview of the problem, deployment details, initial tests, and, for software bugs, steps to reproduce the issue)
5. Include any attachments, if required.
6. Verify all the information entered and click **Submit**.

Feedback to RBR

Report bug or enhancement

General user    Name:     Email address:

RBR employee

Summary:

Description:  
1. Serial number  
2. Overview of the problem  
3. Deployment details  
4. Initial tests  
5. Steps to reproduce the issue  
For RSK / Ruskin issues  
Attachments: Include any datafiles (RSK or HEX) and or photos of the issue

Attachments:

## 4.5 Check for updates

Click on **Help > Check for updates** to search for the latest software version.

Progress Information

! Checking for Ruskin updates...

37% completed

If your software is up-to-date, no further action will be required.

If an update is found, Ruskin will offer to install it. Follow the prompts. Restart Ruskin for the updates to take effect.

## 4.6 Feature codes

Sometimes, RBR may release new features to certain users only, as a beta trial. This includes:

- Features in early development
- Features supporting a new product, in preparation for the product launch
- Features requested by a specific customer

Usually, the goal is to get feedback and improve the feature before its official release. Contact your sales representative or RBR support team at [support@rbr-global.com](mailto:support@rbr-global.com) if you have questions about your feature code.

### Steps

1. Click on **Help > Feature codes...**  
The **Feature codes** window will appear.

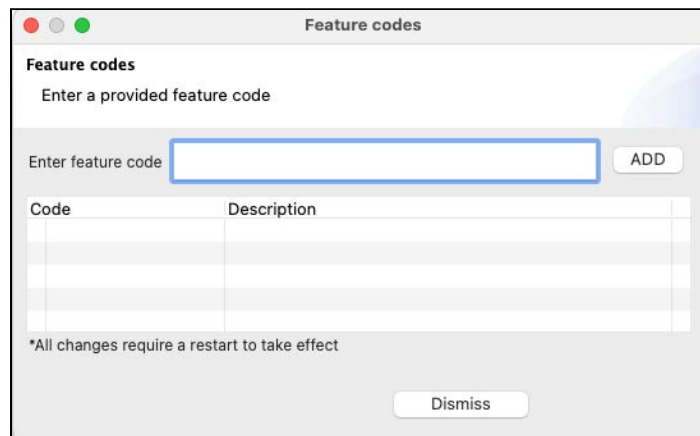

2. Enter the feature code provided by RBR.
3. Click **ADD**.

If the code is correct, Ruskin will save the feature in the local database and enable it. In most cases, you will have access to the new feature immediately, without restarting Ruskin. Otherwise, you will receive any additional instructions at the time when you receive the feature code.

### Errors

1. The feature code is not valid.  
This error may indicate the code was entered incorrectly or it is not compatible with the current version of Ruskin.
2. The feature code is already enabled.  
This error may occur when another user has already activated this code.

## 5 Quick start - Ruskin Desktop

Ruskin Desktop version is designed for computers and laptops. It generates dataset files which include raw measurement data, firmware and software versions, dates and times, sampling settings, power settings, measured and derived parameters, errors and events, calibration coefficients, and diagnostic information, offering the fullest Ruskin experience.

### 5.1 Select Desktop on Ruskin

By default, new deployments started from a laptop or desktop computer are set to the **Desktop** storage format and nothing needs to be adjusted. However, if the instrument has Wi-Fi, it will have **Mobile** selected by default from the factory, facilitating faster downloads. When you start a deployment from your mobile device, the storage format defaults to **Mobile**.

**!** The raw data is not stored when operating an instrument with data storage format set to **Mobile**. The [RSK file](#) will only contain the calibrated data.

You may prefer your datasets to contain raw data with the ability to change calibration coefficients. In this case, go to the **Configuration** tab and open the **Storage** dropdown menu under **Options**. Select **Desktop**.

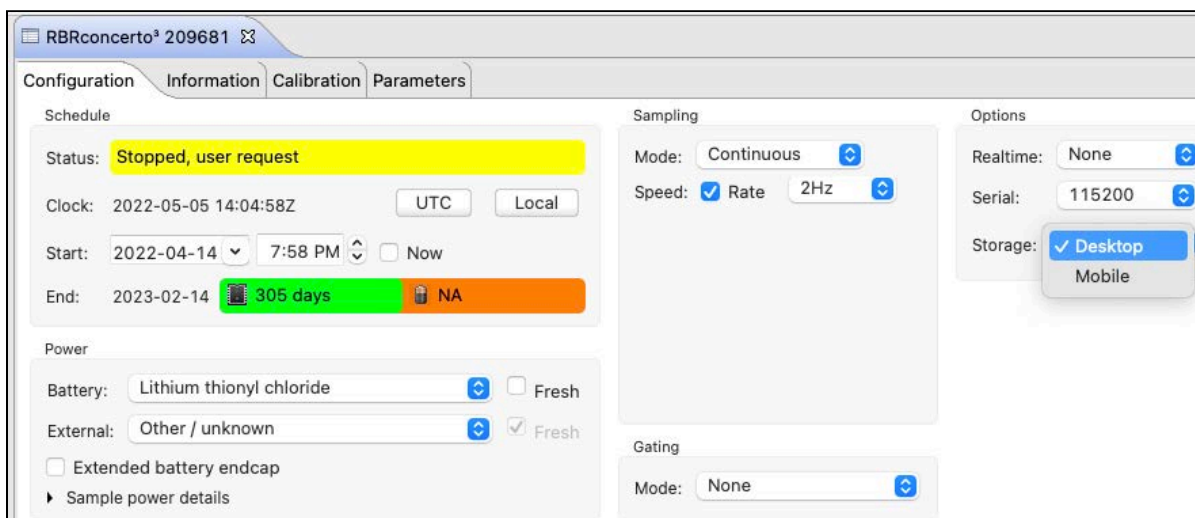

Ruskin Desktop can download datasets created in either Mobile or Desktop format. However, when **Mobile** is selected, you will not be able to edit calibration coefficients and recalculate the data.

**!** You cannot change between **Desktop** and **Mobile** storage formats during the same deployment. Stop your deployment, change the setting, then start a new deployment.

## 5.2 Simulate an instrument

Ruskin can simulate most instruments and sensors that RBR produces. We recommend that you experiment with different simulated options before enabling a schedule for your actual deployment. This practice will also help you become more familiar with how an RBR instrument interacts with Ruskin and how to configure its settings and features. Work with simulated instruments the same way as you work with a real RBR instrument, configuring, calibrating, and fetching data.

**⚠** Currently, simulated instruments cannot be enabled or downloaded. For more information, see [Deploy your instrument](#).

### Steps

1. From the **Instruments** menu, click **Simulate an instrument**.

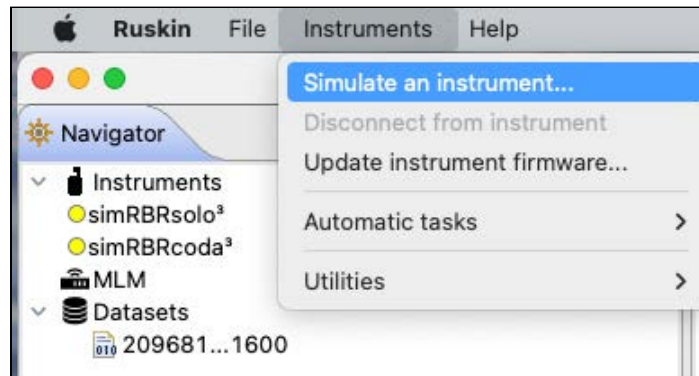

The **Configure simulated instrument** dialog box will appear.

**⚠** Depending on the instrument selected, the **Options** dropdown menu may contain | fast sampling rates, | tide and | wave variants, tilt, or no options at all (in that case, the menu will be greyed out).

2. Click your instrument family and make your selections.  
Within the **Standard instruments** family, Ruskin will identify the type of instrument to simulate based on the number and type of channels you include. If you select only one channel, Ruskin will simulate the *RBRvirtuoso*<sup>3</sup>. If you select more than five channels, it will become the *RBRmaestro*<sup>3</sup>. The name of the instrument and its generation will be displayed in the top section of the dialog box, for example, "Late 2017 - *RBRconcerto*<sup>3</sup> C.T.D".

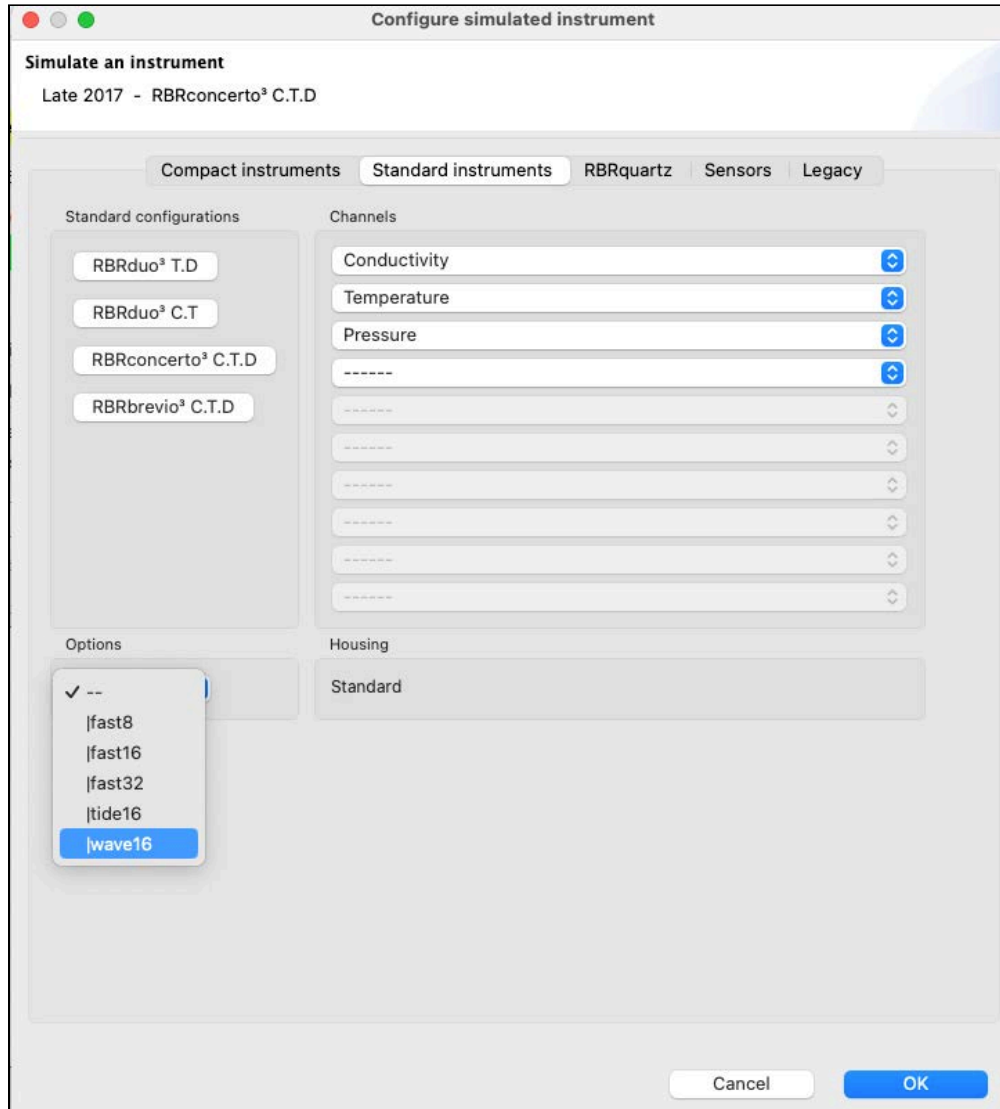

3. Click **OK** to proceed.
4. Your instrument will appear under **Instruments** in the **Navigator** view. Simulated instruments will have a prefix "sim" in the front of their name.

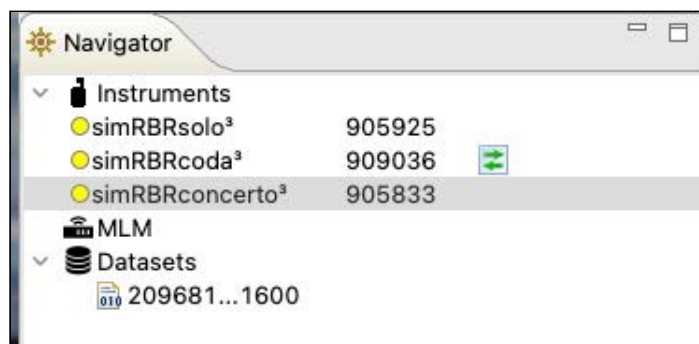

The instrument properties will be displayed on the right, under four tabs.

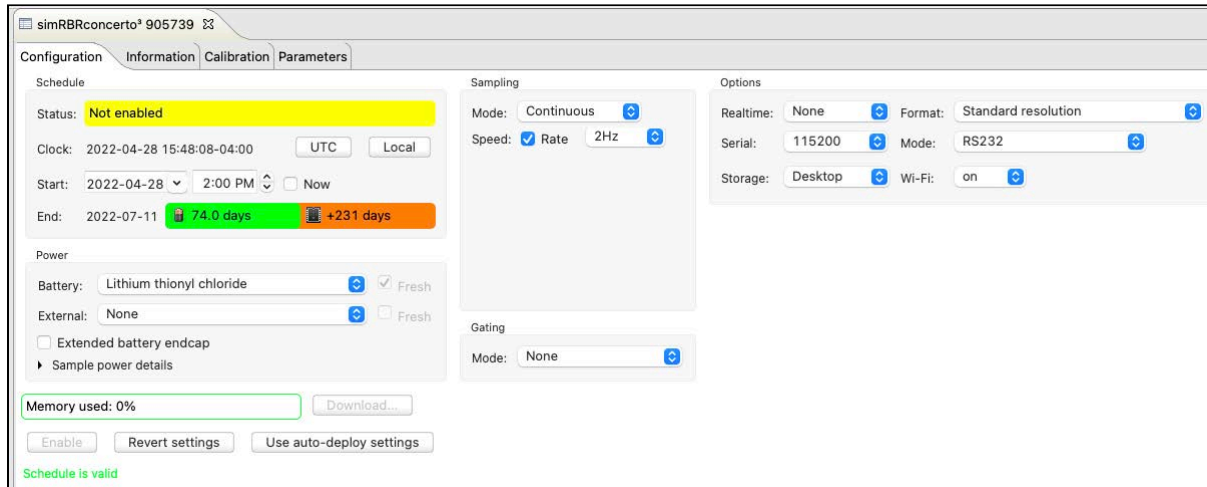

- The **Configuration** tab displays status, clock, sampling mode and speed, serial connection details, power options, and deployment estimates based on these parameters
  - The **Information** tab includes general details, such as the instrument model, generation, serial number, firmware version, power source, battery status, and the channels
  - The **Calibration** tab allows access to the current calibrations for each channel in the instrument
  - The **Parameters** tab outlines default values used by the sensor when performing computations and derivations
5. Familiarise yourself with the instrument by changing configuration options and comparing deployment estimates. Select the desired configuration using the dropdown options or entering the values manually in the fields provided. For simulated instruments, the **Plot** window will remain empty unless you click the **Fetch** button 🏠.
  6. Manage multiple instruments by switching between them in the **Navigator** window.

✔ To remove a simulated instrument from Ruskin, right-click it in the **Navigator** window, and select **Disconnect from instrument**. You can also use the **Instruments** menu. Alternatively, simply close its **Plot** tab by clicking the **X**. The instrument will disappear from the list.

## 5.3 Deploy your instrument

Before using your RBR instruments, you may want to experiment with different options by [simulating your instrument](#) on Ruskin. When you are ready to use your physical RBR instrument, follow the steps below to ensure that you measure exactly what you want on the first attempt.

### Steps

1. Remove the battery end-cap. See "Opening and closing the instrument" section in the corresponding RBR Instrument Guides for more details. The Guides are available on Ruskin under **Help > Documentation**.
  2. Locate the USB-C port. For most standard instruments, it is inside the housing, next to the battery cover. For the RBRquartz<sup>3</sup> BPR | zero and RBRquartz<sup>3</sup> Q | plus, it is inside the end-cap.
  3. Plug one end of the the USB cable (USB-C to USB-C, provided with your instrument) into this port and the other, in the USB port on your computer.
- The instrument will appear in the **Navigator** view after a few seconds. The properties for the instrument will be displayed in the **Properties** window, grouped under four tabs: **Configuration**, **Information**, **Calibration**, and **Parameters**.

4. If you are using the instrument for the first time, you can use either the default preferences or specify your own. For more information, see **Preferences > General**. You can change them at any time.
5. Click the instrument you want to use. Verify that it contains the expected sensors under the **Information** tab.
6. Click the **Calibration** tab to view or modify calibration coefficients.
7. Click the **Configuration** tab and go to the **Sampling** section to select the mode and speed of measurements.

✔ Ruskin will allow a deployment to run until the instrument can no longer sample. This could be due to a full memory or due to power supplies being exhausted. It will display the estimated battery usage and storage capacity based on the parameters you enter. The green widget next to **End** will indicate the number of days your instrument would be sampling, along with the icon representing the limiting factor, battery or memory. Carefully consider this information before you enable a deployment schedule. For more information, see [Schedule](#).

8. Click the **Enable** button at the bottom of the **Configuration** tab to take samples according to the schedule that you specified. Your deployment will continue until the battery runs out, the memory is full, or you stop your schedule manually.

✔ If you want your data streamed or fetched, specify these preferences before you enable the schedule:

- Click the **Configuration** tab and select the streaming option from the **Realtime** dropdown menu (**Serial** or **USB**).
- To see live data sampled every few seconds, click the **Fetch** button  on the far right of the toolbar above the **Plot** view, without enabling the schedule.
- To start streaming, click **Enable**. The data will immediately appear in the **Plot** window below. The instrument does not store streamed or fetched samples, but Ruskin will record them in the realtime RSK file.

9. When your deployment stops, click the **Download...** button at the bottom of the **Configuration** tab to transfer all the sampled data from the instrument to your computer. For more information, see [Download](#). As soon as you download a new dataset, it will appear in the **Navigator** window. Refer to [Datasets](#) for details on managing and analysing your data.

✔ To restore a closed connection to an instrument on Ruskin, click **Instruments** in the **Navigator** window. A list of all instruments physically connected to your computer will appear in the **Properties** window. Find your instrument and deselect its checkbox, and then select it again. Your instrument will re-appear in the **Navigator** window.

## 5.4 Recover your instrument and download data

When deployment is complete, recover your instrument and follow these steps to download your data.

⚠ Flooded instruments may be under pressure and opening them may be dangerous. Take precautions when opening an instrument after deployment.



## Steps

1. Start Ruskin.
2. Carefully remove the battery end-cap. See "Opening and closing the instrument" section in the corresponding RBR Instrument Guides for more details. The Guides are available on Ruskin under **Help > Documentation**.
3. Locate a USB-C port inside of the instrument.
4. Plug one end of the USB cable (USB-C to USB-C, provided with your instrument) into this port and the other, in the USB port on your computer.
5. The instrument will appear in the **Navigator** view after a few seconds.
6. Under the **Configuration** tab, click **Download...** . See [Download](#) for details.

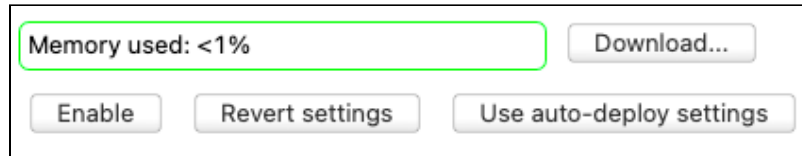

7. Save the file to your local drive. See **Preferences > General** on steps to set up your default location.
8. Evaluate your data. See [Analysis](#) for details.

## Disconnect from your instrument

To disconnect an instrument from Ruskin, right-click it in the **Navigator** window, and select **Disconnect from instrument**. You can also use the **Instruments** menu.

Alternatively, simply close its **Plot** tab by clicking the **X**. The instrument will disappear from the list. Please note that you will be able to reconnect to it at any time because Ruskin remembers the port of a plugged instrument.

## Reconnect to your instrument

To restore a closed connection to an instrument on Ruskin, click **Instruments** in the **Navigator** window. A list of all instruments physically connected to your computer will appear in the **Properties** window, under the [Connections](#) tab.

Find your instrument and deselect its checkbox, then reselect it again. Your instrument will re-appear in the **Navigator** window.

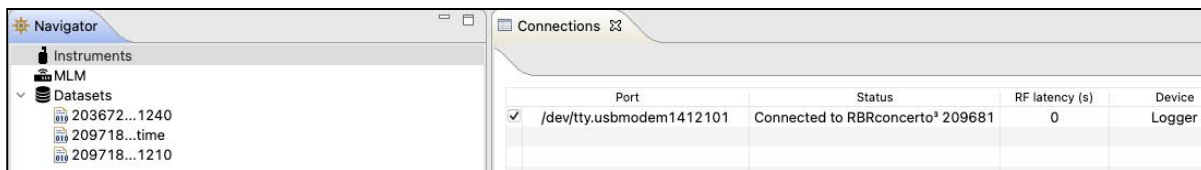

## Remove your instrument

To completely remove your instrument from Ruskin, unplug it from your computer.

Alternatively, deselect the checkbox next to your instrument, and Ruskin will disable transport to its port.

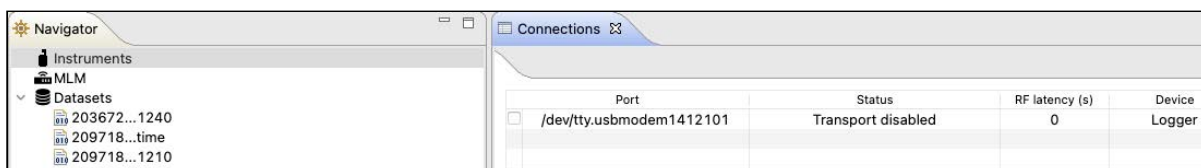

## 6 Quick start - Ruskin Mobile



Ruskin Mobile is a light version of Ruskin, with all the essential functions needed to manage deployments, and with the added advantages of a smart phone such as augmenting data with GPS tracking, displaying live data and uploading to the cloud. Ruskin Mobile connects to Wi-Fi enabled RBR instruments and works on iPhone®, iPad®, Android™ phone, and Android™ tablet.

Install the Ruskin app on your mobile device by going to the Apple App store or Google Play.

## 6.1 Select Mobile on Ruskin

By default, new deployments started from a mobile device are set to the **Mobile** data storage format, and nothing needs to be adjusted.

However, when you start a deployment from your laptop or desktop computer, it defaults to the **Desktop** format which will limit your abilities to view the dataset on the mobile device.

On some occasions, you may set up your instrument from the laptop with the intention to view the dataset on your mobile device afterwards. In this case, go to the **Configuration** tab and open the **Storage** dropdown menu under **Options**. Select **Mobile**.

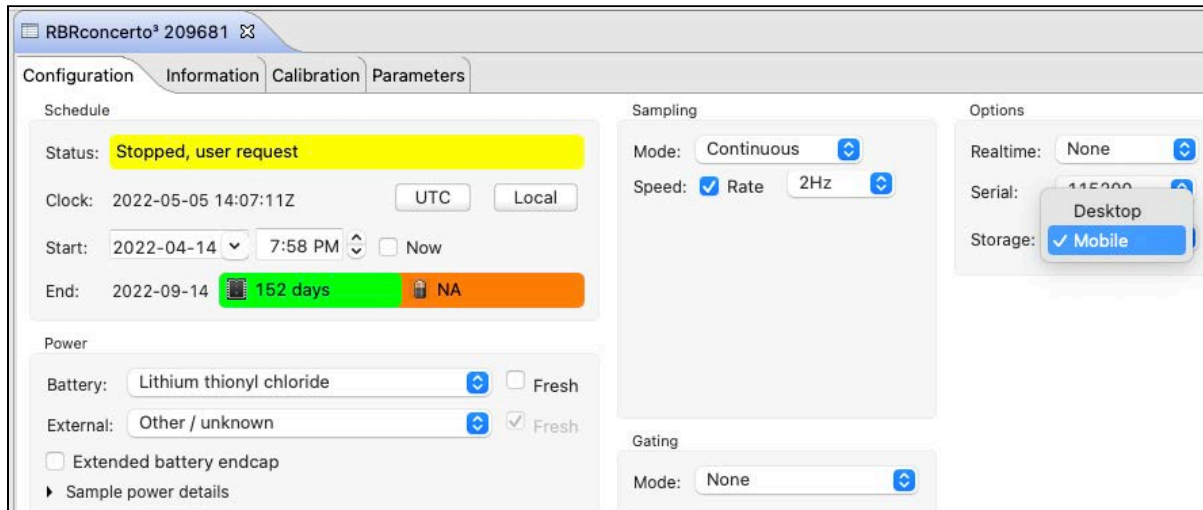

With the **Mobile** data storage format selected, you will be able to track your instrument by adding the GPS location of your phone or tablet to the dataset. The RSK file will store data already calibrated, facilitating faster downloads over the Wi-Fi.

⚠ The raw data are not stored when operating an instrument with the storage format set to **Mobile**. The RSK file will only contain the calibrated data, which prevents re-processing the dataset with new calibration coefficients.

Ruskin Mobile can download datasets created in the **Desktop** format. However, features such as charting will not be available.

⚠ You cannot change between **Desktop** and **Mobile** storage formats for the same deployment. If started in **Desktop** mode, there are two options:

1. Stop the current deployment, change the setting, then start a new deployment.
2. Continue the same deployment in **Desktop** mode, without the ability to view charts. You can still download your dataset, [archive it to Dropbox](#) or another sharing destination, and then use Ruskin Desktop to display it on your computer.

## 6.2 Connect to your instrument

RBR instruments with a built-in Wi-Fi module have the **WI-FI READY** icon on the end-cap and can connect to mobile devices.



The Wi-Fi module needs to be enabled at the time of purchase. Contact [RBR](#) if you have any question about this feature.

**⚠** Any given instrument may be connected to only one device at a time.  
Connect to your instrument and set up all deployment parameters before submerging it.

### Steps

**⚠** Twisting the end-cap to the **RUN** or **PAUSE** position will activate the Wi-Fi. However, twisting to the **PAUSE** position will also pause the instrument.

#### 1. **Android**

- a. Twist the instrument end-cap any direction to activate the Wi-Fi. The Wi-Fi will stay on for 60 seconds, waiting for you to connect.
- b. Open Ruskin  and tap **Search for instruments**.  
If only one instrument is detected, Android will automatically connect and begin downloading the latest dataset.

#### 2. **iOS**

- a. Twist the instrument end-cap any direction to activate the Wi-Fi. The Wi-Fi will stay on for 60 seconds, waiting for you to connect.
- b. Open Ruskin  and tap the convenience button on the landing page. The app will take you to the **Settings** page, from where you will navigate to **Wi-Fi**.  
The instrument will create its own SSID and appear under available Wi-Fi networks. Its name will be the RBR serial number, for example, **RBR 060286**.

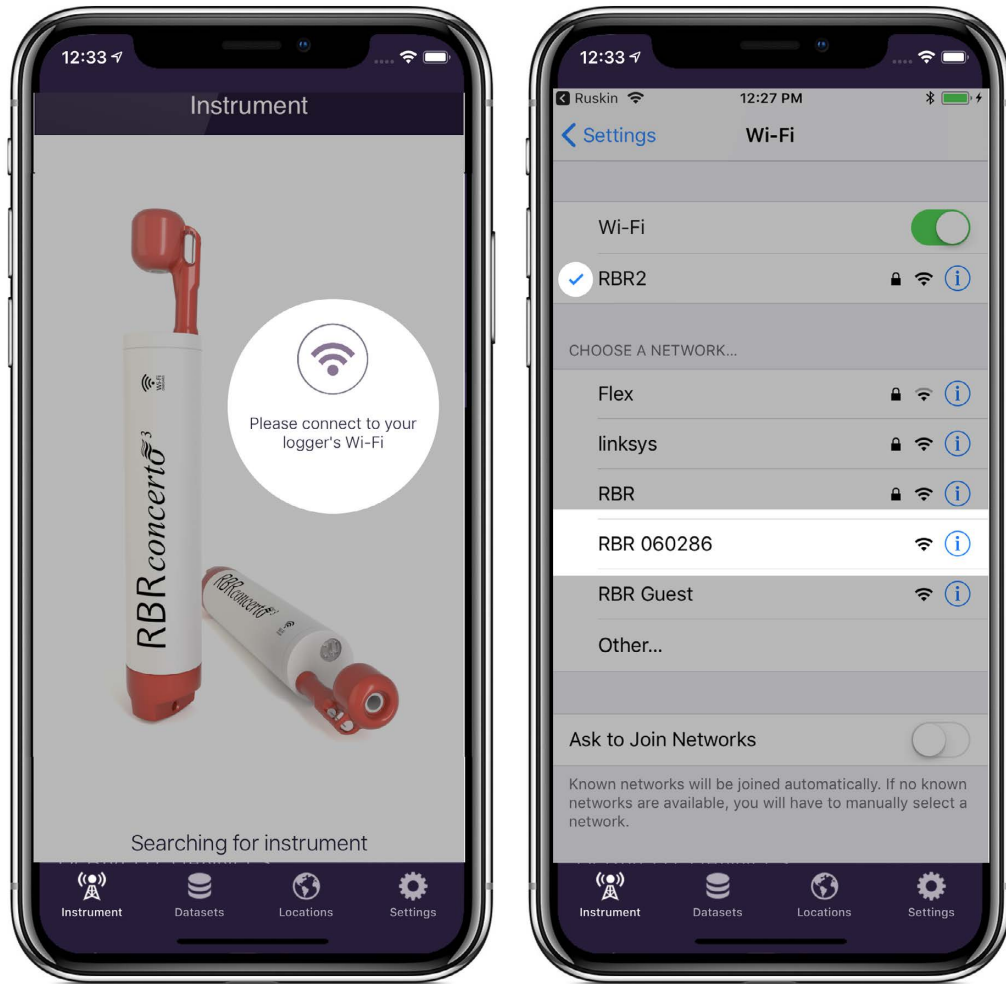

- c. Tap the instrument SSID name to connect and wait for a blue checkmark to appear on the left of the Wi-Fi network.  
A message "No Internet Connection" will appear below. It has no effect on using Ruskin Mobile to manage deployments and refers only to the inability to browse websites while connected to the instrument.

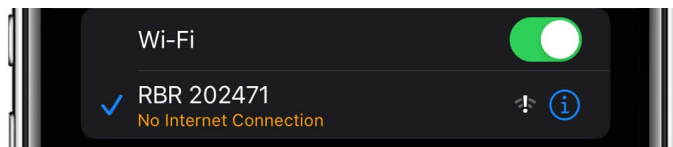

- d. Return to **Settings**, then to the Home screen.
- e. From the Home screen, tap the Ruskin app icon . Ruskin Mobile will automatically connect to the instrument.

 The Wi-Fi is disabled after 60 seconds of inactivity. Twist the end-cap to **RUN** or **PAUSE** to re-activate the Wi-Fi.

There are four views on Ruskin Mobile: **Instrument**, **Datasets**, **Locations**, and **Settings**, accessible via the toolbar at the bottom of the screen.

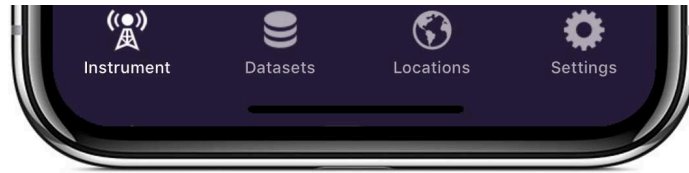

When first connected, Ruskin Mobile will open the **Instrument**  view of the app. Use this tab to set up and manage your deployment.



Tap **Datasets**  to access local datasets and charts, upload datasets to your Dropbox account or another sharing destination, and (optionally) delete archived datasets.

Tap **Locations**  to track your instrument during deployment.

Tap **Settings**  to manage your deployment preferences and share feedback or contact the support team.

## 6.3 Deploy your instrument

The Ruskin Mobile screen is divided into several areas where current parameters are displayed, and includes three operating buttons. There is a toolbar at the bottom of the screen, with four views: **Instrument**, **Datasets**, **Locations**, and **Settings**.

When connected to an instrument, the **Instrument**  view contains information about your instrument and its deployment.

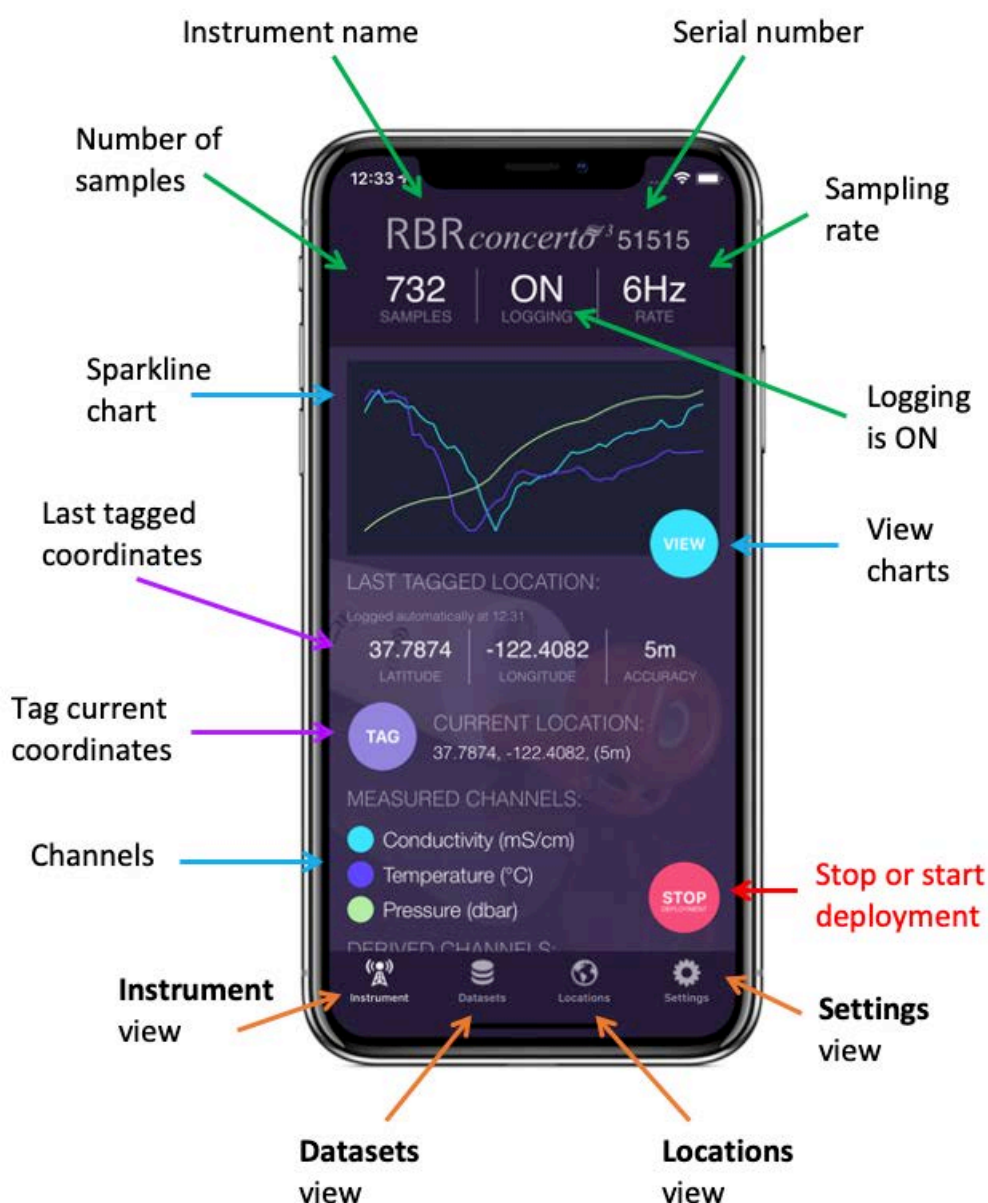

## Status

The top of screen shows the name and serial number of the instrument, followed by its status:

- Number of samples taken
- Logging state (**ON** or **OFF**)
- Sampling rate

When the logging state is shown as **ON**, the instrument is logging data.

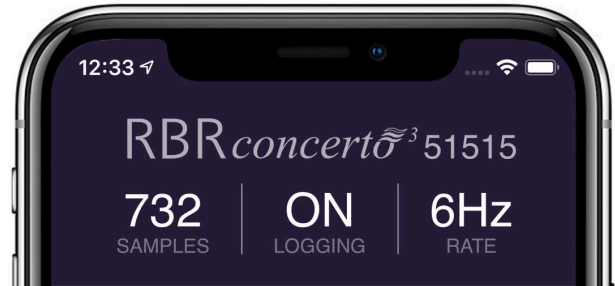

When the logging state is shown as **OFF**, the deployment is paused but still in progress.

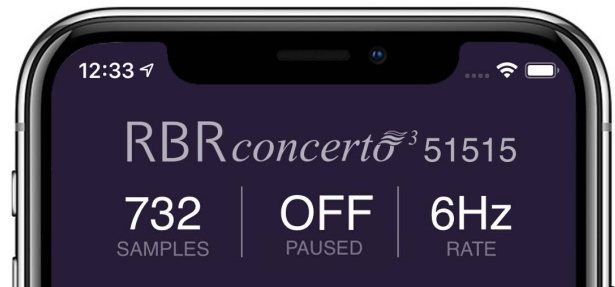

A deployment can have only one sampling rate, thus you cannot change it when logging is just paused.

To adjust the sampling rate, you have to stop the deployment using the red **STOP** button. A message "Deployment stopped" will be displayed, and the sampling rate field will become editable. However, you cannot resume the same deployment after stopping it. After changing the sampling rate, you will have to start a new deployment.

 Once a deployment has been stopped, it cannot be resumed.



## Realtime data

A sparkline chart shows the last 50 readings for each of the measured channels (or the last 150 readings when using a tablet). These are typically out-of-water samples and serve to provide realtime feedback from the instrument.

To view charts of the full deployment, tap the light blue **VIEW** button.



## Geotagging

Your instrument does not have a GPS, but its location information may be available depending your phone/tablet tracking capabilities.

Whenever the Ruskin App connects to an instrument, it automatically logs its location at that moment. Even if the boat moves away from the starting point during download, the initial location will be captured in the dataset. Should a more accurate location fix be attained within the first minute after connection, those coordinates will be used instead.

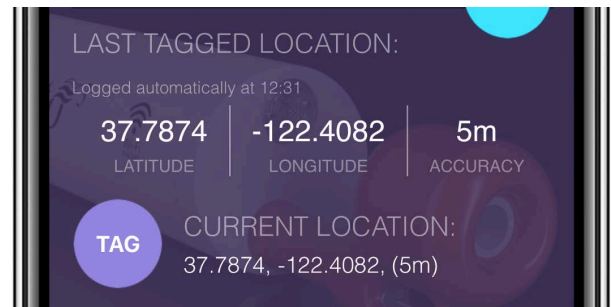

The **LAST TAGGED LOCATION** data indicate when the last GPS coordinates were added to the dataset.

As the app uses GPS, a clear view of the sky will allow a more accurate waypoint, rather than downloading inside a ship cabin, for example. To conserve the battery life of your phone, GPS tracking only occurs when the Ruskin App is open or when you are recording a track of your location.

It can take a few moments after opening the app to get an accurate location fix. When GPS is working well, an accuracy of around 5 metres can be expected.

Tap the purple **TAG** button to log the **CURRENT LOCATION** data manually. The last tagged location will be updated to indicate the coordinates and accuracy of the manual GPS waypoint fix.

Both types of waypoints described (manual tags and those taken automatically on download) can be seen plotted on a map in the **Locations**  tab.

## Channels

Scroll to the bottom of the **Instrument** tab to view measured and derived channels, along with their units of measurement.

The coloured circle to the left of each channel indicates the sparkline colour representing the latest readings from that channel.

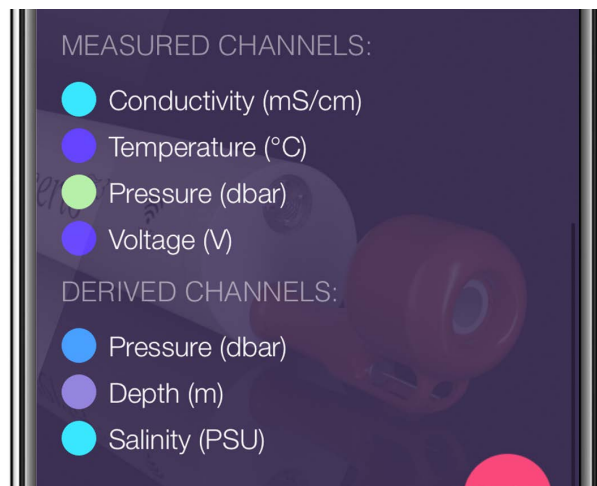

## Deployment

The red button in the bottom right corner reads either **START** or **STOP**, depending on whether a deployment is in progress.

Tap the **START** button to begin a new deployment. When a new deployment is started, the data on the instrument will be erased.

Tap the **STOP** button to end the current deployment. Once a deployment has been stopped, it can not be resumed.



 Use the twist activation feature to pause deployment if you intend to continue with it later.

One dataset is created for each deployment. Deployments are typically long-running and consist of many sampling periods (activated by twisting the end-cap to **RUN**) and paused periods (activated by twisting the end-cap to **PAUSE**). Each deployment can only have one sampling rate, and it cannot be changed while logging is just paused. To change the sampling rate, stop the deployment.

 When the deployment is stopped, twisting the end-cap to either **RUN** or **PAUSE** will activate the Wi-Fi, but the instrument will not vibrate as it is not sampling.

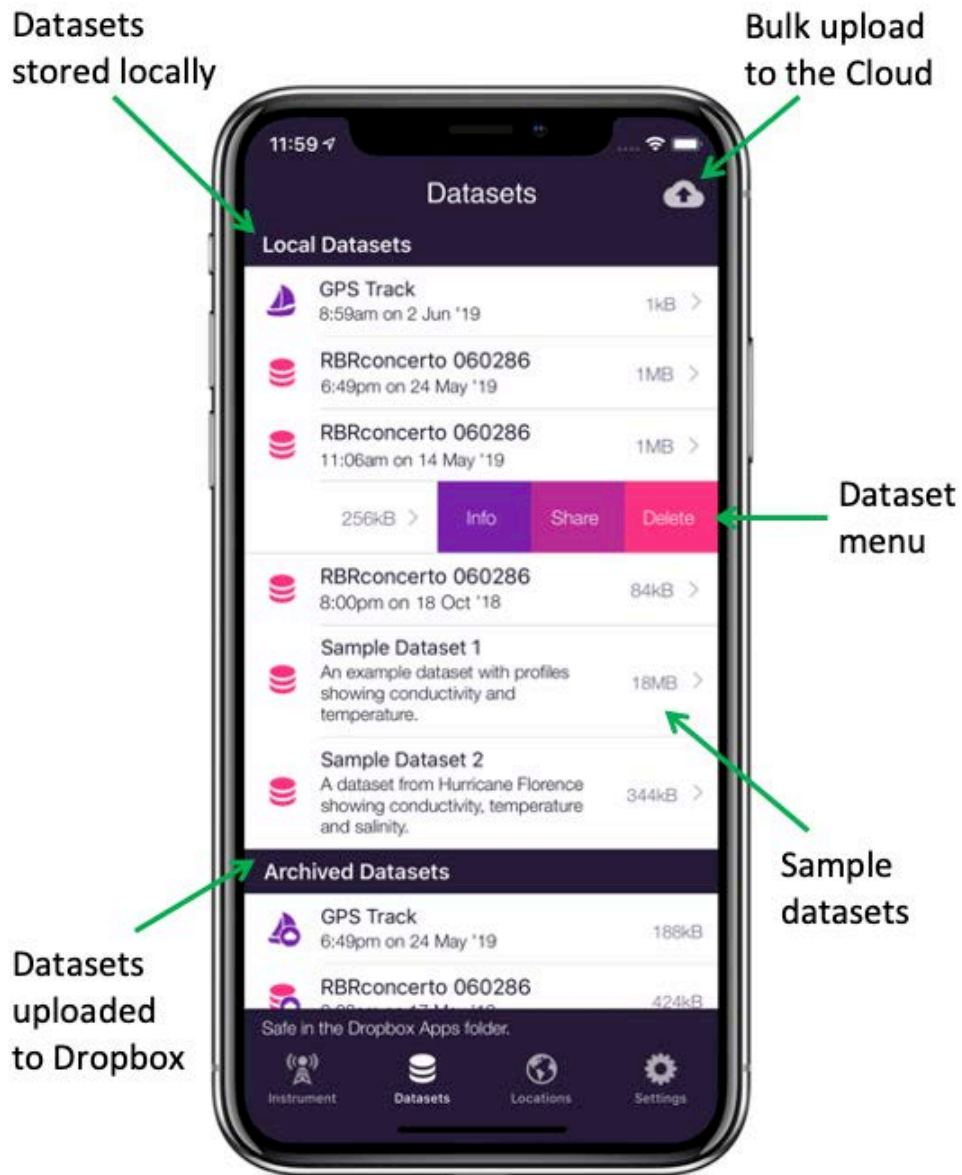

## 6.4 Access datasets and charts

When connected to an instrument, the **Datasets**  view allows access to local and archived datasets.



The **Local Datasets** list includes the datasets stored on your mobile device after they were downloaded from connected instruments. You can view charts for these datasets on your device.

To save space, you may choose to upload your datasets to Dropbox. These datasets will be on the **Archived Datasets** list. If you have not set up your Dropbox and are using other ways to upload datasets from your device, the second list will not appear.

 By default, the datasets will be automatically removed from your device once they are uploaded to Dropbox. Thus, you cannot view charts for archived datasets. To change this preference, go to the **Settings**  tab.

Sample datasets, captured from real deployments, are available to demonstrate the features of the Ruskin app.

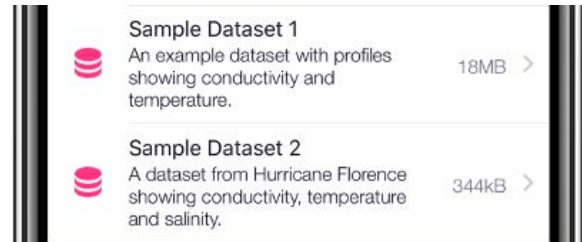

If a dataset is in **Desktop** format instead of **Mobile**, its icon will include an exclamation mark. You will not be able to view charts for this dataset.

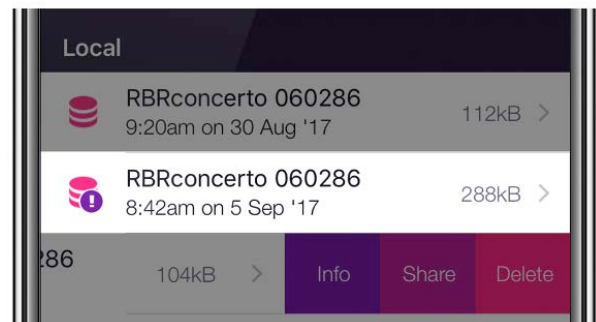

Tap **GPS Track** to display raw GPS tracking data.



Every time the instrument comes out of the water, Wi-Fi automatically turns on and your mobile device records that location. The Ruskin mapping feature uses these GPS coordinates to plot the route of your instrument on the map.

### Uploading and sharing datasets

On iOS, swiping to the left on an item in the **Datasets** list will reveal several operations that can be performed on that dataset: **Info**, **Share**, **Delete**. On Android, long-pressing the item reveals the equivalent context menu.

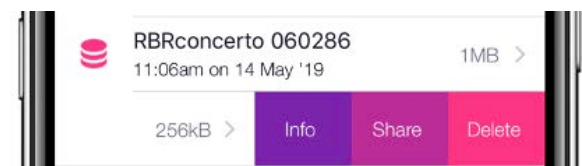

The **Share** option shows a context menu of the available for that dataset. What these are, depends on the apps you have installed on your phone, but a number of options come without additional apps. On iOS these include sharing by email, AirDrop, and saving to Files (as of iOS 11). To see your cloud drive (Google Drive, Baidu, Box, Microsoft OneDrive, iCloud, Dropbox, etc.) as a sharing destination, you need to install that app.





 Sharing options are only available for local datasets.

## Dropbox

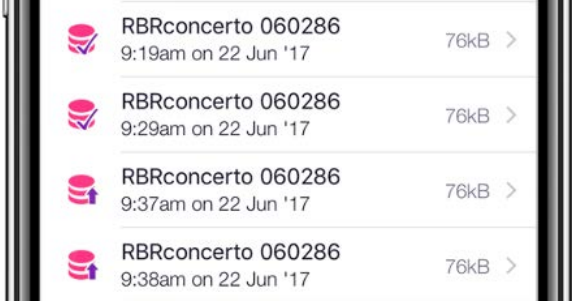
There are additional features available for Dropbox sharing which, incidentally, do not require the Dropbox app to be installed.

To enable Dropbox integration, you must sign in to Dropbox. The option for this is at the top of the **Settings**  tab.



	RBRconcerto 060286 9:19am on 22 Jun '17	76kB >
	RBRconcerto 060286 9:29am on 22 Jun '17	76kB >
	RBRconcerto 060286 9:37am on 22 Jun '17	76kB >
	RBRconcerto 060286 9:38am on 22 Jun '17	76kB >

Press the **Cloud** button in the top right corner of the **Datasets** tab to bulk upload all your local datasets. As the datasets upload, the icon will transition from an upwards arrow to a checkmark.

By default, the datasets will be automatically deleted from your device once they are uploaded to Dropbox. To change this preference, go to the **Settings**  tab.

## Charting

Tap on a dataset on the **Local Datasets** list to view its charts.

 To view charts for the currently connected instrument, go to the **Instrument** view.

The charts are separated into casts (one cast per page). Each time the instrument descends and ascends again is considered to be one cast, and a new chart is created for each. Swipe left and right to view the chart for each cast. In the example shown, the dataset includes 10 casts.

The instrument determines the start and end of a downcast by depth (pressure) readings, and thus only a single chart will be created when testing the out-of-water samples.

In portrait orientation, channel data is plotted by depth, and only downcast data. The upcast data is omitted.

When the instrument sensors face downwards, the downcast provides the most accurate data, while the upcast data can be subtly impacted by the turbulence from the leading instrument housing on the ascent.

Tap on the multi-coloured caption under the plot to open the legend with units of measurement. Use the toggle buttons to select which channels to display on the chart.

**⚠** When viewing out-of-water samples, the downcast chart will appear like a random plot because there is no change in depth.

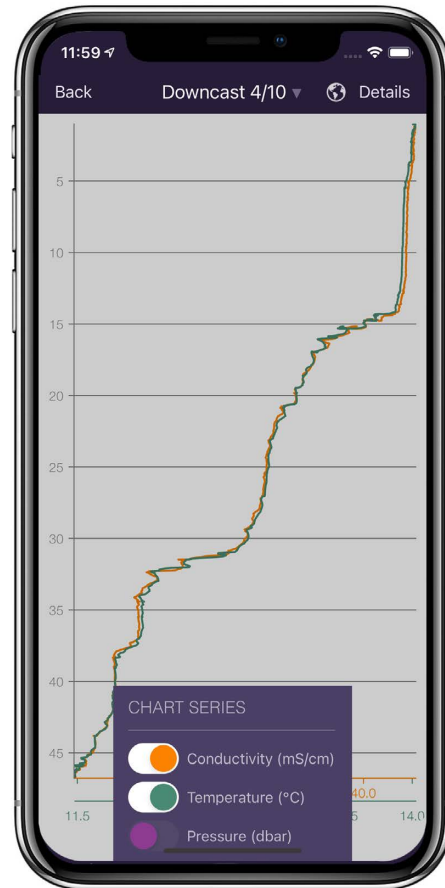

In landscape orientation, the channel data is plotted by time. Depth is inverted, so the bottom reading on the chart intuitively represents the bottom of the cast.



Use pinch-to-zoom to zoom in and out on your data. The chart axes adjust relative to each other on zooming and panning around the chart. As a result, all chart series occupy the full height or width of the chart and can be easily compared side-by-side.

Tap on **Details** in the top-right corner to reveal information about the displayed cast and deployment parameters. The deployment data is also available in the **Info** context menu of the **Datasets** list.

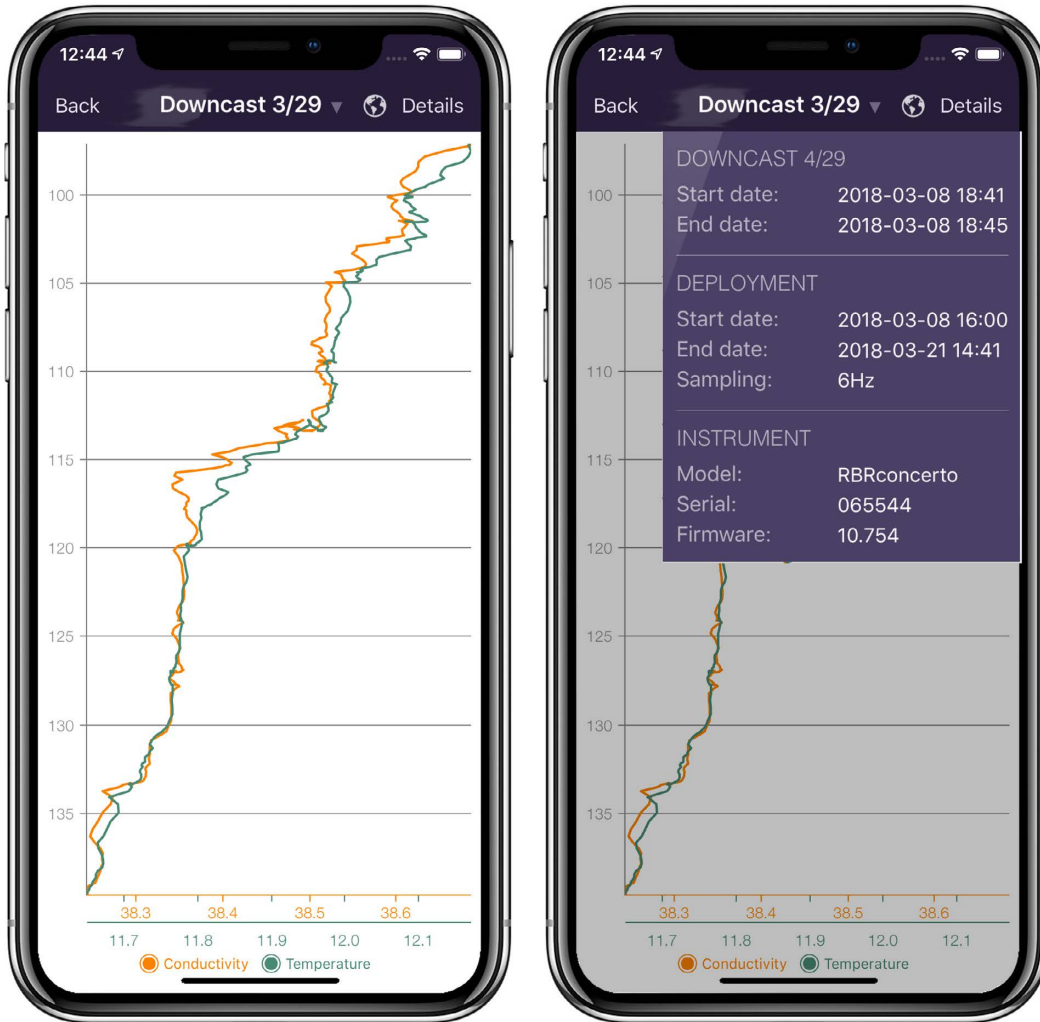

The same deployment data is also available in the **Info** context menu of the **Datasets** list.

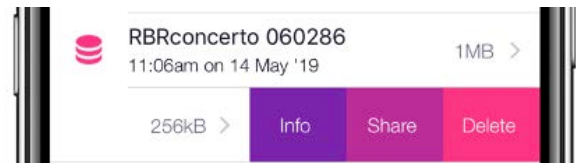

## 6.5 Track your instrument

When connected to an instrument, the **Locations**  view allows you to display its GPS coordinates and plot profiles as data points on a map during deployment. This feature relies on location capabilities available on your mobile device.

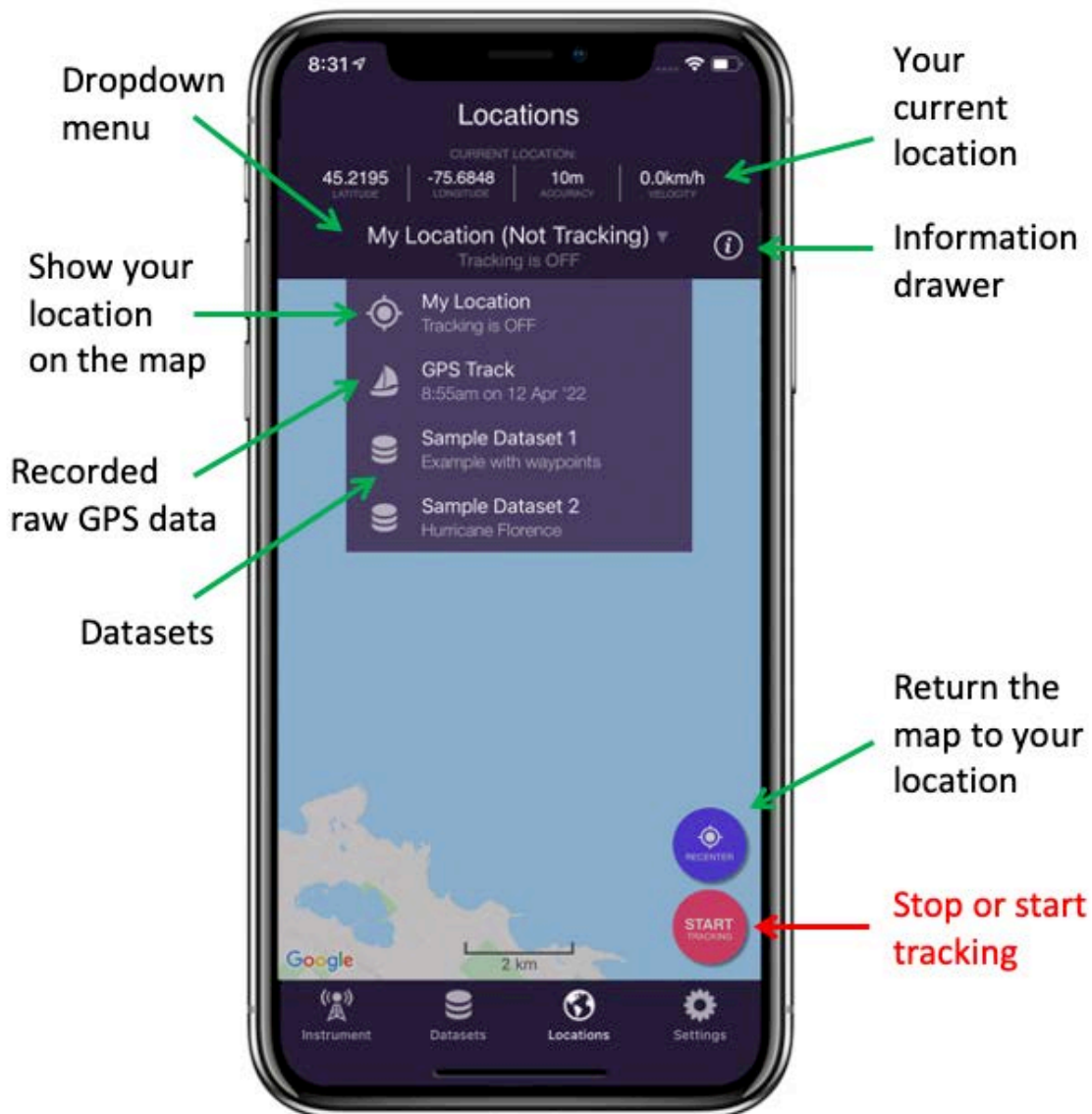

### Tracking

 The Ruskin tracking feature relies on location capabilities of your mobile device. When the boat is towing the instrument, the phone and the instrument are at the same location at the any given time. The app knows where the instrument was for each sample and adds this information to the dataset, thus ensuring continuous tracking.

The red button in the bottom right corner reads either **START** or **STOP**, depending on whether tracking is in progress.



Tap the red **START** button to start tracking. A red tracking banner will appear at the **Locations** icon in the toolbar.

The first time you use this feature on iOS, you will see a prompt, "Allow Ruskin to also access your location even when you are not using the app". Select **Always allow**; otherwise, when you leave the app, tracking will cease.

Follow your deployment on the map, or view a broader context by using pinch-to-zoom or panning away from your track. Tap the purple **RECENTER** button to return to your location.

Tap the red **STOP** button to stop tracking.

Unless you tap STOP, tracking will continue for up to 24 hours, even with the app in the background. On iOS, you can also interrupt GPS tracking by force-closing the app: double-tap the home button and swipe upwards (or, on iOS devices with faceID: swipe upwards and pause in the centre of the screen, then swipe up on the app to be closed).

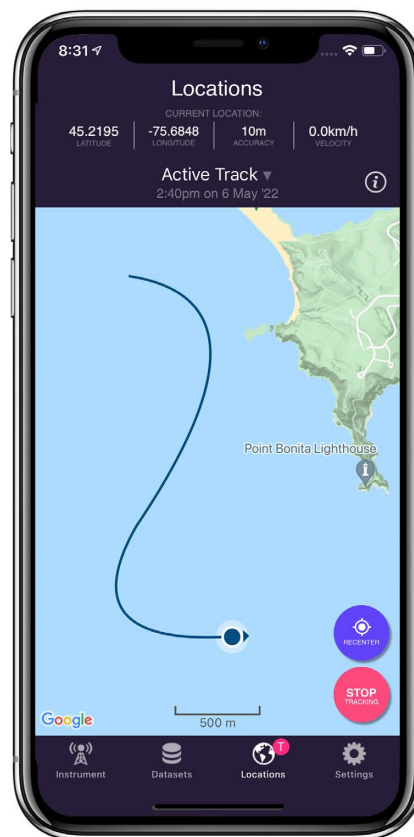

✔ To save battery power, stop GPS tracking when you stop deployments.

### GPS track files

A waypoint is automatically added to the RSK geodata table whenever the instrument connects and also whenever you tap the purple **TAG** button in the **Instrument** view. Raw GPS data is saved as a GPS track file in the GPX format.

When a deployment is in progress, its track will be displayed on the dropdown menu as **Active track**. All previously recorded tracks are displayed as a **GPS Track** with time and date listed below.

Tap **GPS Track** in the dropdown to open a track file. You can also access and manage them from the [Datasets](#) view.

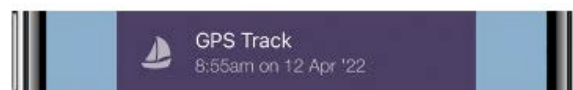

When you open a previously recorded track in the **Locations** view, the current location details disappear from the header along with the red **STOP** button and blue **RECENTER** buttons. This does not affect the recording of the current track. To view current location stats or stop tracking, open the dropdown menu and tap **Current Track**.

One track creates one tracking file. When you open it, there will be no profiles, tags, or download pins. Track files use the GPX format, augmented with a couple of minor extensions. A track file is independent of any RSK, but Ruskin uses it to inject location data into the RSK whenever the RSK is downloaded. The RSK geodata table will contain one row for every GPS entry captured during the deployment.

In most cases, you do not need to access the GPX file as RSK contains all the needed data. However, you have an option to upload the GPX files from the Ruskin app independently of RSKs. You may wish to use a track to illustrate your course on a map using various online tools, or convert it to other formats such as [GeoJSON](#) or [KML](#).

### Profiles

Open the dropdown menu and tap on a dataset.



A map will open, showing the tracked route recorded during deployment. Tap on the **Information drawer** button at the top right to view the details related to deployment, waypoints, instrument, and map type.

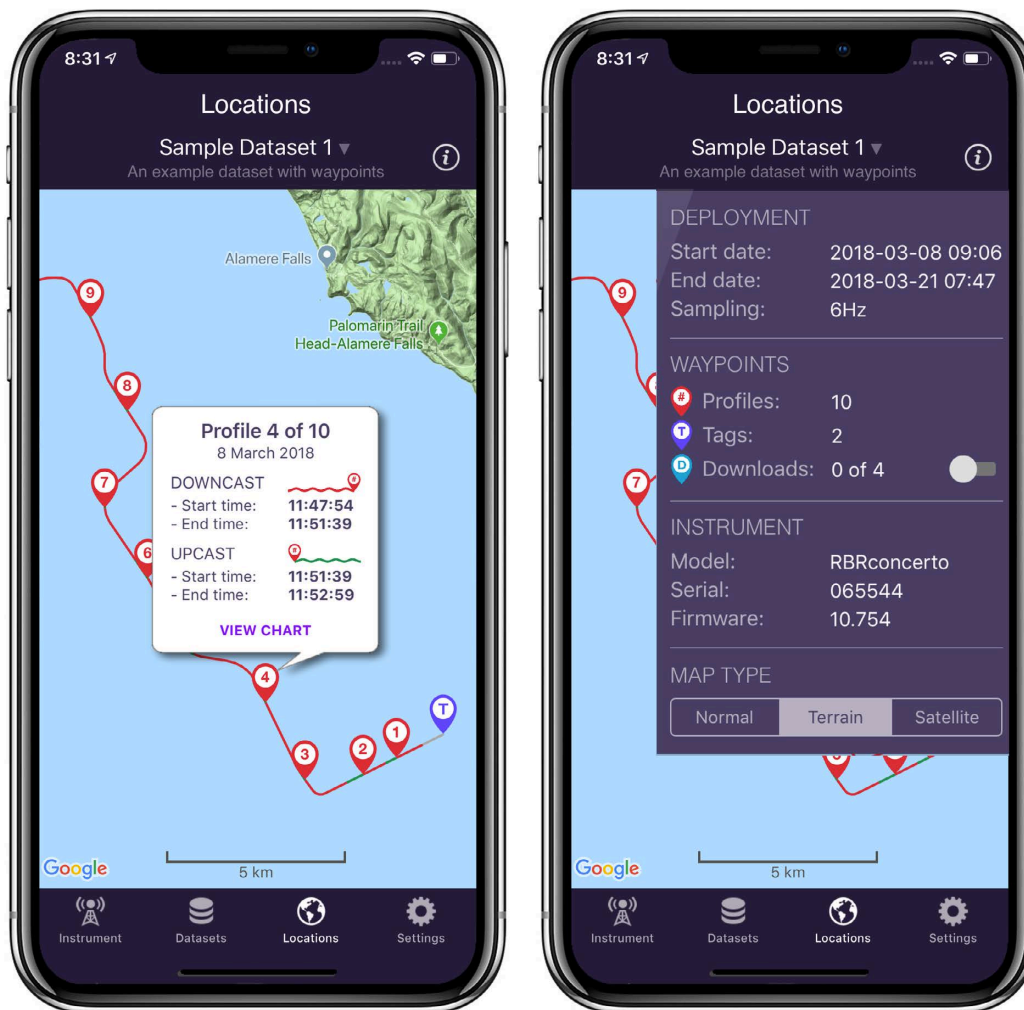

There are three colours used to draw the track:

1. A red line for the downcast segments
2. A green line for the upcast segments
3. A light grey line for segments not associated with the profile (e.g. out-of-water periods)

There are three types of tag pins used to mark locations:

- Red profiles tag pins with numbers
- Purple manual tag pins with a letter "T"
- Blue download tag pins with a letter "D"

Download tags are automatically added whenever the instrument downloads to your mobile device. Typically, it occurs when the instrument ascends and reaches the surface, or at the end of a deployment. They are hidden by default. Use the toggle switch on the information drawer to display them. You will see them appear whenever the line colour changes from green to red, and at the very end of the track.

Tap on a tag pin to open an information window. For the red profile tag pins, it includes a link to view the chart for that profile.

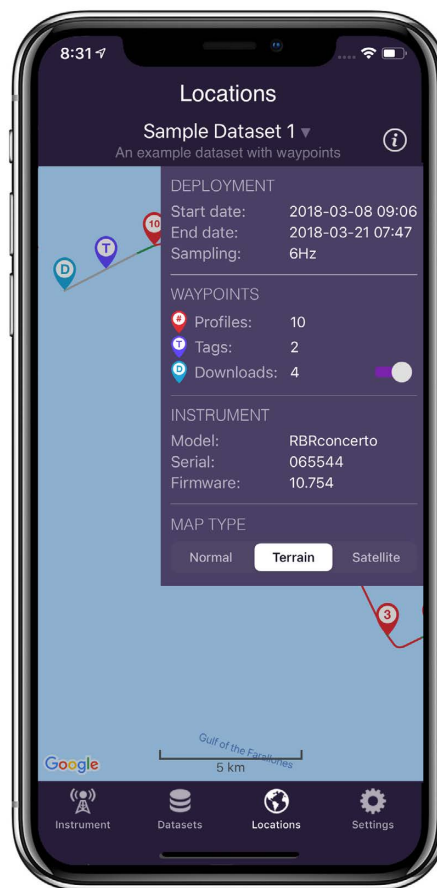

If no raw tracks coincide with a deployment, only download and manual tag pins will be displayed. Download pins are hidden by default, so if there are no manual tag pins, the map may appear empty.

In the absence of track data, Ruskin Mobile searches for any automatic waypoints from instrument downloads and will sometimes be able to position some profiles from these and thus display some profile pins.

If track data is not available for the full deployment, some profile pins may be missing from the map. Refer to the information drawer to see how many profile locations could be determined.

## 6.6 Adjust your settings

When connected to an instrument, the **Settings**  view allows you to manage your deployment preferences.

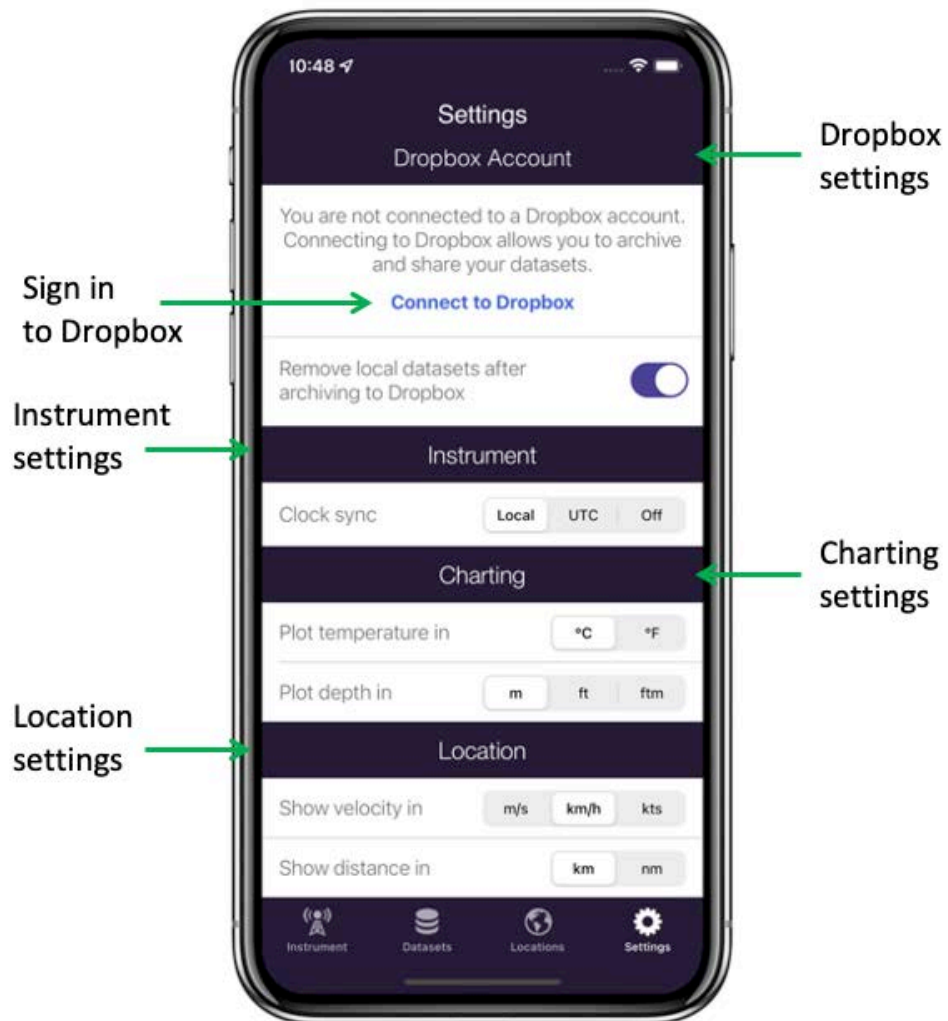

### Dropbox

Sign in to Dropbox to enable Dropbox integration. Click on **Connect to Dropbox** and follow the prompts.



By default, the datasets will be automatically deleted from your device once they are uploaded to Dropbox. Use the toggle switch to change this preference.

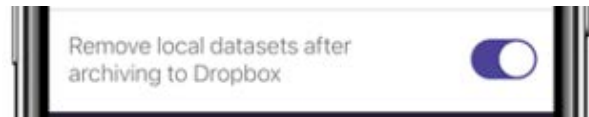

### Clock Sync

When you start a deployment, you can automatically set the instrument time from your phone or tablet.

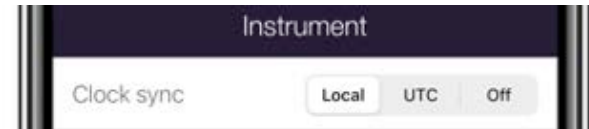

As the instrument has a clock but no concept of time zones, you can select **UTC** or **Local** time, or you may choose to set no time at all by selecting **Off**.

When you remove batteries from your instrument for more than a few seconds, the clock will reset (back to the epoch). Starting a new deployment with the **Clock sync** option enabled provides a convenient way to correct the clock.

### Units of measurement

By default, your charts will plot temperature in Celsius and depth in metres.

Change your viewing preferences to Fahrenheit for temperature and feet or fathoms by making your selections under **Charting**.

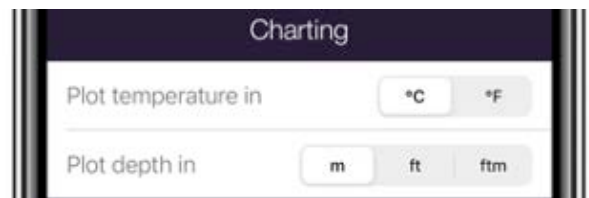

**i** Alternative units of measurement will allow you to view the charts in preferred format, but will not affect the units in which the data were originally captured in the datasets.

By default, your maps will use kilometres per hour for velocity and kilometres for distance.

Change your viewing preferences to metres per second or knots for velocity units and nautical miles for distance by making your selections under **Location**.

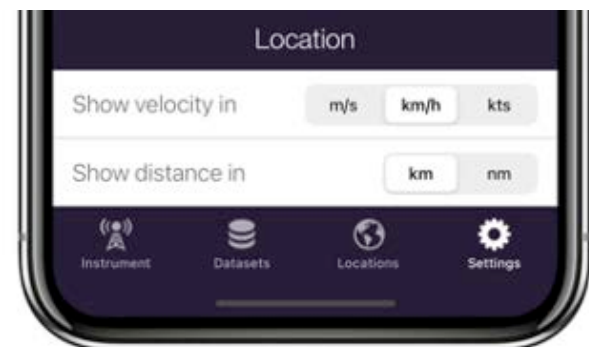

## 7 Connections

Use the **Connections** tab to view and manage devices connected to your computer via physical ports or Ethernet.

In the **Navigator** window, click **Instruments**. The **Connections** tab will open on the right. The table will include ports, statuses, RF latency selections, and the device type for each connected device.

Port	Status	RF latency (s)	Device
<input checked="" type="checkbox"/> /dev/tty.usbmodem141101	Connected to RBRconcerto <sup>3</sup> 209681	2	RS-485
<input checked="" type="checkbox"/> 192.168.4.063:23	Connected to MS-310	0	Logger
<input checked="" type="checkbox"/> /dev/tty.usbserial-AI05TREB	Connected to RBRduet <sup>3</sup> 206199	1	Logger
<input checked="" type="checkbox"/> 192.168.5.023:12	Connected to NMEA GPS	2	GPS
<input type="checkbox"/> 127.0.0.1:2	Unable to connect to host	3	Logger
		4	
		5	
		6	
		7	
		8	
		9	
		10	
		11	
		12	
		13	
		14	
		15	
		16	
		17	
		18	

Column	Information
<b>Port</b>	If your instrument is plugged in to your computer, this column will identify the physical port by name, such as " <b>COM5</b> " (if using Windows) or by its address, such as " <b>/dev/tty.usbmodem141101</b> " (if using MAC OS).
<b>Status</b>	The column will display a success message, such as " <b>Connected to RBRconcerto<sup>3</sup> 209681</b> ", or an error message, such as " <b>Unable to connect to host</b> ".
<b>RF latency (s)</b>	From the dropdown menu, select a value up to <b>29</b> seconds. The selected value will extend the allowable time for an instrument to respond to a command. Use this option when on a long cable or slow Wi-Fi connections.
<b>Device</b>	The column will display the device type for each connected device: <ul style="list-style-type: none"> <li>• <b>Logger</b>: Instruments connected via USB, serial (RS-232), or TCP connections</li> <li>• <b>RS-485</b>: Instruments connected via serial (RS-485) connections</li> <li>• <b>GPS</b>: NMEA streaming devices</li> </ul>

See [Deploy your instrument](#) on how to locate the USB-C port on your instrument and connect it to your computer.

As soon as you plug in an instrument, Ruskin will detect it and add it to the list.

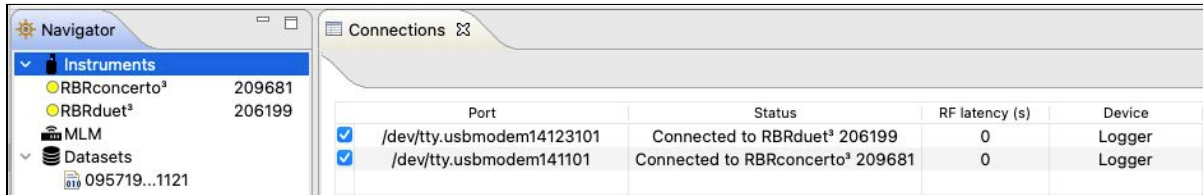

Click on one of the instruments to switch to its [Configuration](#) tab.

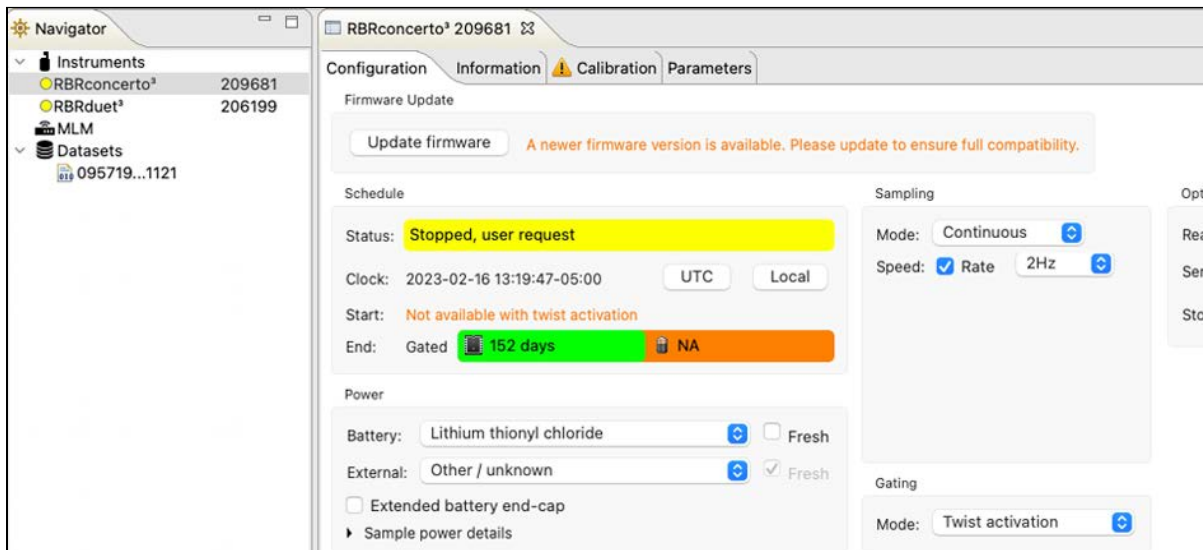

If you unplug an instrument, the port will remain enabled as long as the port checkbox remains selected. Ruskin will automatically reconnect to the instrument when it is plugged back in.

Deselect the checkbox next to your instrument to disable transport to its port. After this, Ruskin will not detect any instrument plugged into this port.



To restore transport, reselect the checkbox. Your instrument will re-appear in the **Navigator** window.

## 8 Configuration

Use the **Configuration** tab to set up your deployment parameters.

After setting up a desired schedule, verify that it meets your requirements. To return to previous settings, click **Revert settings**.

To save the settings for the new schedule, click **Enable**. New values will replace all previously stored schedule parameters.

**⚠** You cannot use **Revert settings** after clicking **Enable**. To change a schedule already enabled, stop the instrument, restore old values manually, and click **Enable** again.

To apply the same schedule to multiple instruments with the same sampling capabilities, set up the first instrument and click **Enable**. Connect all other instruments to Ruskin and click [Use auto-deploy settings](#). Now all instruments will run on the same schedule, including logging times, power options, sampling parameters, and gating conditions. See [Automatic tasks](#) for details. To return to previous settings, click **Revert settings**.

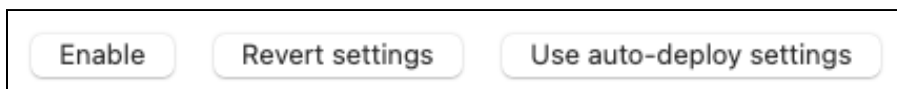

**✓** Enabling a new schedule will remove all the existing data on the instrument. Make sure to download the data from the instrument before starting a new deployment.

### 8.1 Update firmware

Ruskin automatically checks if your instrument firmware is up-to-date. Updates may be critical, routine, or customised.

If a newer version is available and this update is critical, the **Update firmware** button and a warning message will appear at the top of the **Configuration** tab.



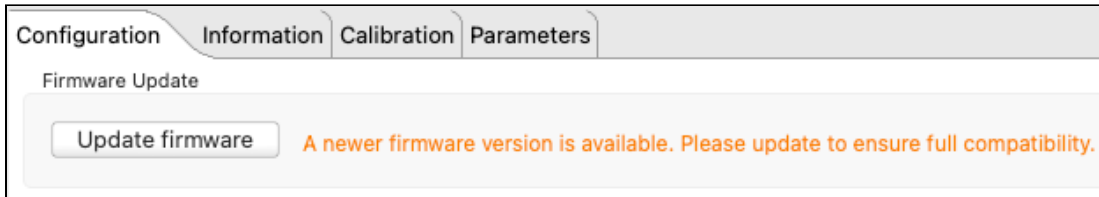

See [Critical firmware updates](#) for details.

## 8.2 Schedule

The **Schedule** section includes four fields: **Status**, **Clock**, **Start**, and **End**.

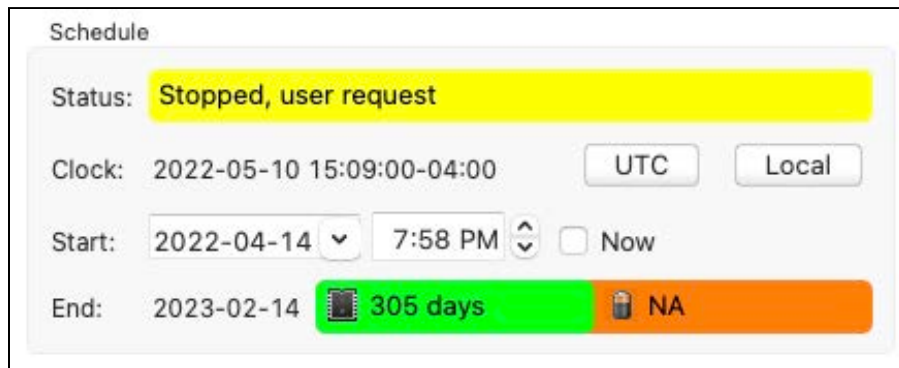

### Status

The **Status** field displays the current state of your instrument.

Status	Description
Not enabled	A deployment has not been enabled.
Configuring instrument	Ruskin is writing the deployment configuration to the instrument.
Schedule enabled	A deployment has been enabled, but the start time has not yet been reached.
Paused	A deployment has been enabled, but a gating condition has not been met.
Logging in progress	A deployment has been enabled and the instrument is currently obtaining samples and recording them to memory.
Logging, memory full	A deployment has been enabled and the instrument is currently obtaining samples, but they are not being recorded to memory as there is no available space. Data continues to be transmitted over the chosen realtime link.
Stopped, schedule complete	A deployment has reached the end time and so has been stopped.
Stopped, memory full	The memory has been completely filled with samples and so logging has been stopped.
Stopped, user request	An enabled deployment has been stopped by user intervention.
Failed	An internal error has occurred during a deployment.
Battery failed	An internal error with regarding the batteries has occurred.

## Clock

The instrument clock may drift up to 60s per year. Hover your mouse over the time value to display the offset.

Configuration Information Calibration Parameters

Schedule

Status: Not enabled

Clock: 2023-01-23 14:22:26-04:00 UTC Local

Start: 2022-04-18

End: 2022-06-01 44.1 days +3.6 days

Logger time lags computer time by 7.860s

Synchronise the instrument clock before each deployment. Select **UTC** or **Local** time, depending on your preferences.

## Start

**⚠** The **Start** date and time are only editable if the **Gating** condition is set to **None**. Otherwise, it is the **Gating** condition selection that will control the start of logging. See [Gating](#) for details.

Specify the **Start** date using the dropdown calendar, and the **Start** time using the up and down arrows. Alternatively, check **Now** to start logging as soon as the **Enable** button is clicked.

**✓** To manually edit the originally set date and time values, select and then clear the **Now** checkbox.

## End

The **End** date is calculated by Ruskin autonomy engine and indicates when your deployment is likely to stop. This is based on sampling schedule, mode, and power selections. Ruskin autonomy engine provides feedback on which parameter (power or memory) will be exhausted first.

End: 2019-09-23 115 days +496 days

The parameter in the **green** bar is the true deployment estimate. In the example shown, your deployment will last 115 days, until the battery is exhausted.

**⚠** Deployment estimates on Ruskin assume new batteries. Your real deployment times may be shorter if the batteries are not fully charged.

The parameter in the **orange** bar indicates how much longer the deployment could last if the preceding parameter were not a factor. In the example shown, if your instrument were still powered after 115 days, it could continue logging for 496 days more, until the memory becomes full.

✓ If the **End** logging date is power dependent and you know that the instrument will be operating under very cold conditions, you may want to lower the demands on the battery by [lengthening your sampling period](#) or opting for different [battery chemistry](#).

## Ruskin autonomy engine

Ruskin autonomy engine relies on several parameters to estimate the deployment end date: sampling rate, power options, and memory. One of the key factors is battery life.

Battery life prediction is a complicated issue. In RBR instruments, it is a strong function of the type of instrument, type and number of sensors attached, sampling mode (sampling rate, gating conditions, realtime data collection), and water temperature during the deployment. Manufacturer's data for the batteries may not reflect the way batteries are used in RBR instruments, and thus, are not always informative.

Autonomy figures depend on the power draw of the instrument, as well as the derated capacity of the battery pack. Batteries are derated to 4°C. These values differ for different [battery chemistries](#). For the most accurate deployment estimates, select the same batteries from the dropdown menu as installed in your instrument.

Ruskin calculates the expected battery usage for the instrument during setup. The nominal capacity of each type of battery is described in the [Power](#) section and is given in mAh at room temperature. Battery voltage does not decrease linearly and is therefore not an accurate indicator of battery capacity.

RBR tested batteries of various brands at 6°C; all of them were able to provide the threshold capacity defined in the [Power](#) section. View these predictions and further de-rate the batteries if the expected deployment is in cold water.

The software will warn you if the expected battery usage for a particular deployment scenario is approaching the theoretical potential mAh.



The software will not prevent your instrument from being started even if a warning is given. However, adjusting deployment parameters or replacing the batteries may help extend deployment times.

## 8.3 Power

The **Power** section includes internal and external power options, as well as information on sampling power. Ruskin autonomy engine uses these parameters to estimate deployment life.

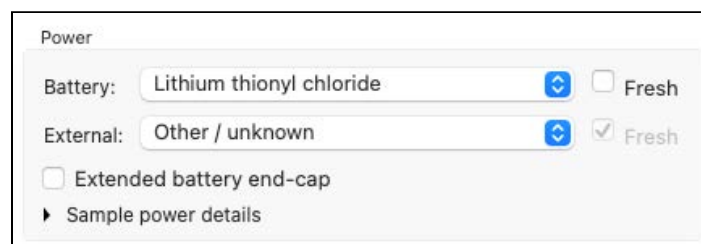

## Battery

The **Battery** dropdown menu shows available chemistry options for internal batteries. The list depends on your instrument.

RBR ships all new instruments with batteries of the highest capacity for the instrument type already installed.

⚠ Mixing batteries of different chemistries, brands, and age will reduce performance and potentially damage the instrument. Improperly matched batteries may become overheated, leak, or even explode.

## AA-type batteries

Most RBR instruments use AA-type batteries, the only exception being the RBquartz<sup>3</sup> Q | plus, which uses D.

⚠ Lithium thionyl chloride batteries are only recommended for T, D, T.D, C.T, C.T.D, and RBRquartz<sup>3</sup> instruments. Any additional sensors will not work correctly on this type of battery.

Typically, RBR instruments are shipped with EVE ER14505 lithium thionyl chloride or Energizer L91AA lithium iron. Select your battery chemistry from the dropdown list.

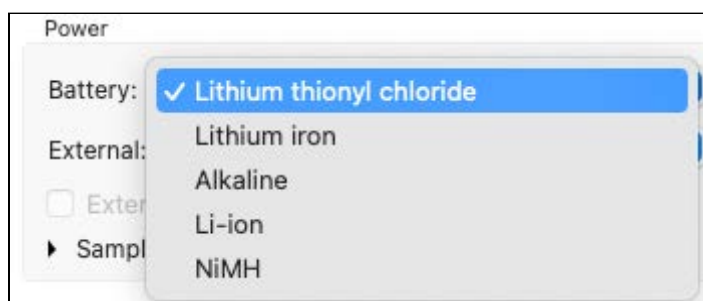

Name	Chemistry	Voltage (V)	mAh*
Lithium thionyl chloride	Li-SOCl <sub>2</sub>	3.6	2700
Lithium iron	Li-FeS <sub>2</sub>	1.5	3500
Alkaline	Zn-MnO <sub>2</sub>	1.5	2500
Li-ion	Li-NiMnCo	3.6	750
Nickel metal hydride	Ni-MH	1.2	2400

\*The nominal capacity of each type of battery is given at room temperature.

## D-type batteries

The RB*quartz*<sup>3</sup> Q | plus uses D-type batteries and is typically shipped with Tadiran TL-4930 lithium thionyl chloride. Select your battery chemistry from the dropdown list.

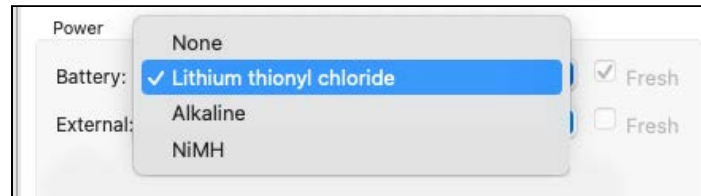



Name	Chemistry	Voltage (V)	mAh*
Lithium thionyl chloride	Li-SOCL <sub>2</sub>	3.6	18400
Alkaline	Zn-MnO <sub>2</sub>	1.5	16000
Nickel metal hydride	Ni-MH	1.2	10000

\*The nominal capacity of each type of battery is given at room temperature.

## Deployment estimates

Ruskin estimates autonomy figures based on the power draw of the instrument, as well as the derated capacity of the batteries. Batteries are derated to 4°C. These values differ for different chemistries (see above). For the most accurate deployment estimates, select the same batteries from the dropdown menu as installed in your instrument. Alternatively, use Ruskin to simulate your instrument with different batteries and find which chemistry works best for your deployment.

 Battery cells of the same chemistry but from different manufacturers may have different performance. If the nominal capacity of the battery model you are using is lower than outlined above, your actual deployment may be shorter than the estimate.

 Replace batteries before each deployment to maximise the operational time and prevent data loss.

Select the **Fresh** checkbox when installing fresh batteries in your instrument for the next deployment. When checked, Ruskin autonomy engine will reset usage statistics and adjust deployment estimates accordingly.

## External

The **External** dropdown menu shows external power supply options. These include RBR*fermata* and RBR*fermette*<sup>3</sup> underwater battery canisters with various battery chemistries available. RBR*fermata* uses D-type batteries, and RBR*fermette*<sup>3</sup> uses AA cells. See above for battery chemistries available. Ruskin autonomy engine will estimate deployment life based on your selections.

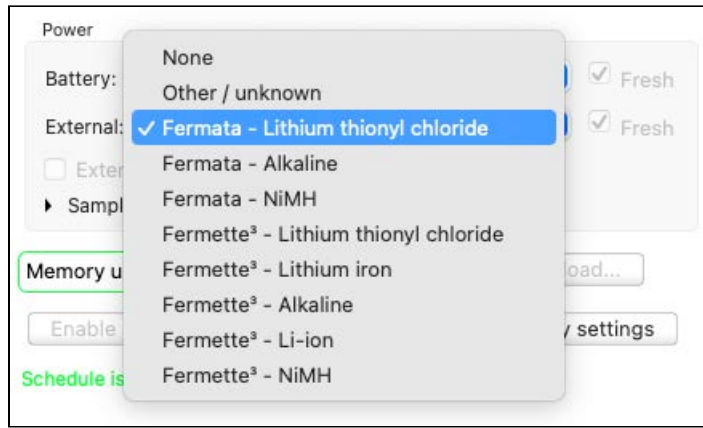

Select the **Fresh** checkbox when using a new battery canister or after replacing batteries in your RBR*fermata* and RBR*fermette*<sup>3</sup> before the next deployment. When checked, Ruskin autonomy engine will reset usage statistics and adjust deployment estimates accordingly.

Select the **Extended battery end-cap** checkbox only if your instrument has a connectorised end-cap. In this case, Ruskin autonomy engine will account for the power supplied via the end-cap when estimating deployment life. Otherwise, leave the box unchecked.

### Sample power details

Click on the arrow to open the information drawer with sample power details, such as energy per sample, sample duration (if applicable), and sleep power.

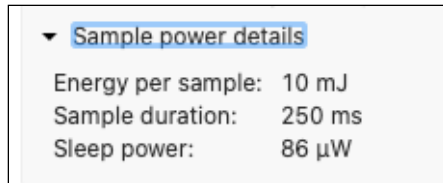

## 8.4 Sampling

The **Sampling** section includes three fields: **Mode**, **Speed**, and **Rate**, as well as several optional fields available with certain sampling modes.

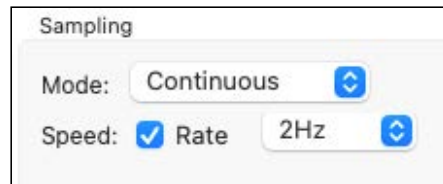

## Mode

Depending on your instrument, different dropdown options may be available. See [Average](#), [Burst](#), [Directional](#), [Tide](#), and [Wave](#) for information on how to configure these modes.

**i** The RBR*quartz*<sup>3</sup> BPR | zero can only operate in **Continuous** sampling mode.

RBR*concerto*<sup>3</sup> C.T.D:

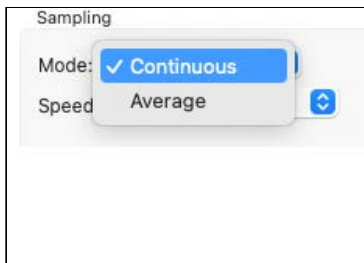

RBR*quartz*<sup>3</sup> Q:

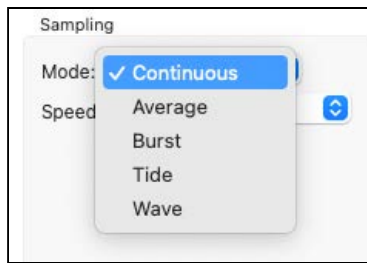

RBR*quartz*<sup>3</sup> BPR | zero:

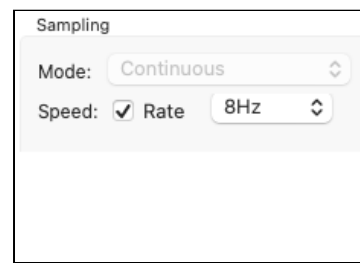

## Speed and Rate

These are the only two parameters you need to configure **Continuous** sampling mode.

Check **Speed** to select the sampling **Rate** in Hz from the dropdown menu. The default option is always the highest instrument rating; for example, | fast16 will default to 16Hz.

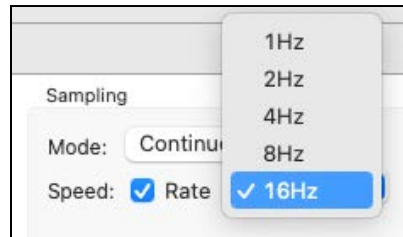

**i** All profiling instruments (known as | fast) can sample faster than 2Hz and support [Average](#) and [Burst](#) modes. All | tide and | wave instruments can average at rates of 2, 4, 8, or 16Hz.

Uncheck **Speed** to enter the sampling **Rate** manually in hours, minutes, and seconds (HH:mm:ss format). The fastest rate to enter manually is 1s. Type the numbers in, or use the up and down arrows.

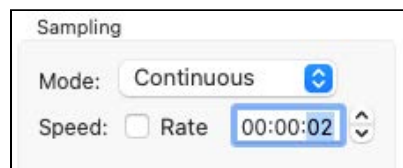

## 8.4.1 Average

When set to **Average**, the instrument will collect data at a certain rate, and then average those samples to produce a single value to store on the instrument. This sampling mode allows you to save memory during long deployments.

In addition to **Speed** and **Rate**, there are two more parameters required for **Average** mode: **Duration** and **Interval**.

**Duration** specifies the time range over which to average. It must always be longer than **Speed**.

**Interval** is the repetition period for performing the averaging. It must always be longer than **Duration**.

There are two versions of sampling controls for **Average** sampling mode: simple and advanced. Make your selections in **Preferences > General**.

### Simple sampling controls

When using the simple version, select **Speed**, **Duration**, and **Interval** from pre-defined options in three dropdown menus.

In the example shown, the sampling rate selected is 2Hz (two samples per second). The instrument will be logging for a duration of five seconds, then pause and average the ten samples collected. After an interval of five minutes, it will start logging again, repeating the same cycle.

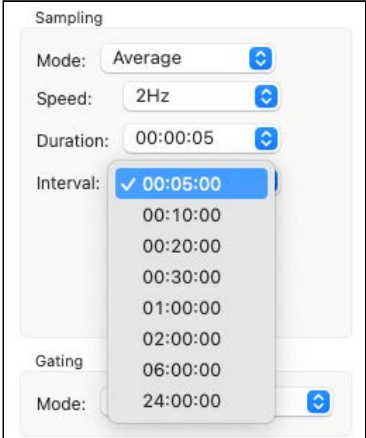

### Advanced sampling controls

When using the advanced version, select two or all three parameters manually.

In the example shown, the sampling rate selected is 2Hz (two samples per second). The instrument will be logging for a duration of one minute, then pause and average the 120 samples collected. After an interval of five minutes, it will start logging again, repeating the same cycle.

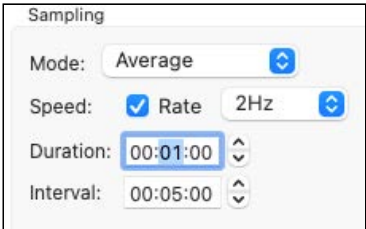

In the second example, the sampling rate selected is 1s (1Hz, or one sample per second). **Duration** and **Interval** are the same in both examples.

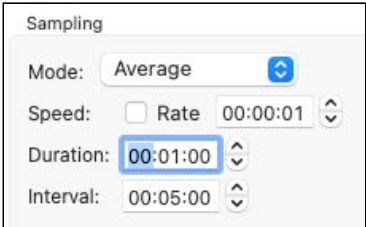

**i** At every **Interval**, the instrument records only one sample, averaged over all samples collected during the period of **Duration**. The rest of the samples are discarded after averaging is performed.



## 8.4.2 Burst

When set to **Burst**, the instrument will collect a specified number of samples at a specified rate, and repeat this operation at a specified interval.

 Only instruments with the | fast sampling feature (| fast8, | fast16, or | fast32) support **Burst** sampling mode.

In addition to **Speed** and **Rate**, there are two more parameters required for **Burst** mode: **Duration** and **Interval**.

**Duration** specifies the number of samples to record.

**Interval** is the repetition period for performing the burst. The countdown begins at the same moment the burst starts and, therefore, **Interval** must always be longer than the time it takes to obtain the number of samples indicated in **Duration**.

There are two versions of sampling controls for **Burst** sampling mode: simple and advanced. Make your selections in **Preferences > General**.

### Simple sampling controls

When using the simple version, select **Speed**, **Duration**, and **Interval** from pre-defined options in three dropdown menus.

In the example shown, the sampling rate selected is 2Hz (two samples per second). The instrument will be logging for a duration of 512 samples (256 seconds), then pause for 44 seconds (that is, until the countdown reaches 300s or five minutes). After an interval of five minutes, a new burst of 512 samples will occur, the instrument repeating the same cycle.

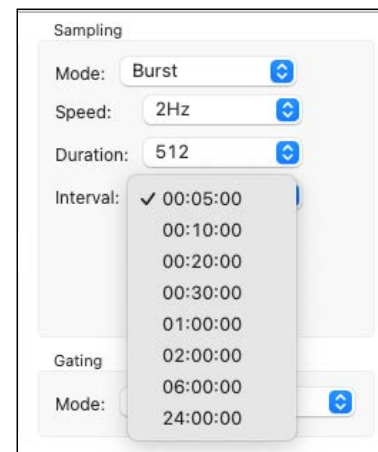

### Advanced sampling controls

When using the advanced version, select two or all three parameters manually.

In the example shown, the sampling rate selected is 32Hz (32 samples per second). The instrument will be logging for a duration of 512 samples (16 seconds), then pause. After an interval of ten minutes (minus 16 seconds), a new burst of 512 samples will occur, the instrument repeating the same cycle.

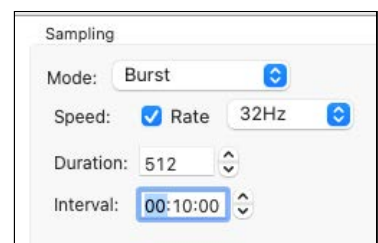

In the second example, the sampling rate selected is 1s (1Hz, or one sample per second). **Duration** is 60 samples, and **Interval** is five min, which means the instrument will be logging for one minute until pausing for four.

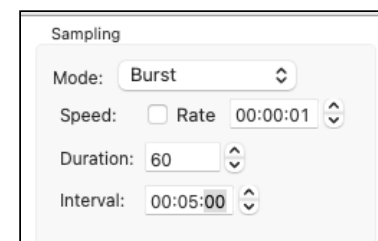

### 8.4.3 Directional

When set to **Directional**, the instrument will collect data at specified rates depending on the direction it is travelling. This sampling mode is intended for use when the instrument is integrated into a moving platform.

 Only instruments with the |fast sampling feature (| fast8, | fast16, or | fast32) support **Directional** mode.

There are several parameters required to set up **Directional** mode: **Threshold**, **Fast sampling direction**, **Fast sampling speed**, and **Slow sampling speed**.

**Threshold** is the distance from the previous minimum or maximum (in dbar) at which the instrument will switch to the opposite sampling speed. This value should be greater than zero. The minimum precision is 0.1dBar.

To optimise deployment life without compromising data in the preferred direction, it is recommended to set the **Threshold** value to 5-10% of expected profile distance.

**Fast sampling direction** indicates which direction the instrument should sample at the fast rate.

- **Ascending** indicates that the instrument should sample at the **Fast sampling speed** during ascents
- **Descending** indicates that the instrument should sample at the **Fast sampling speed** during descents

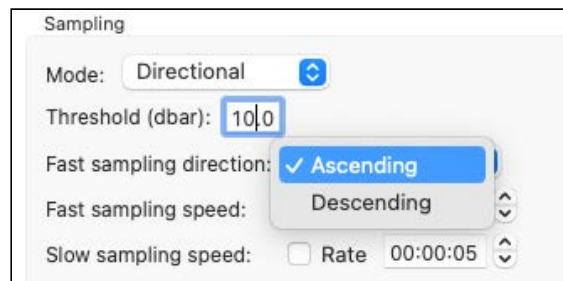

**Fast sampling speed** has the same meaning as **Speed** in **Continuous** mode, but applies only when the instrument detects that it is moving in the preferred **direction**.

This must be faster than the provided **Slow sampling speed** parameter.

**Slow sampling speed** has the same meaning as **Speed** in **Continuous** mode, but applies only when the instrument detects that it is not moving in the preferred **direction**.

This must be slower than the provided **Fast sampling speed** parameter.

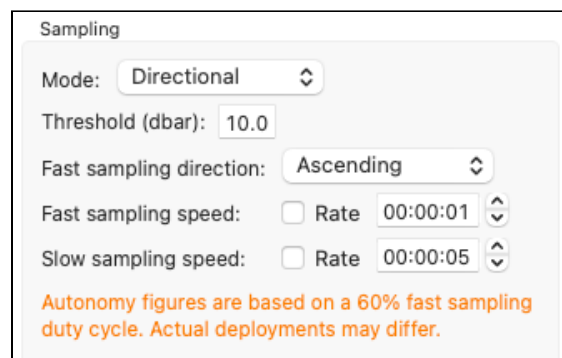

Refer to the graph below for different scenarios of directional logging. In this example, the **Fast sampling direction** is set to **Ascending**.

#### First profile

The instrument must record one complete profile to obtain the first minimum and maximum, which will serve as initial points for the threshold. Due to this requirement, it will sample the entire first profile using the **Fast sampling speed** (black dots). Once this has been completed, it will perform the desired sampling functionality.

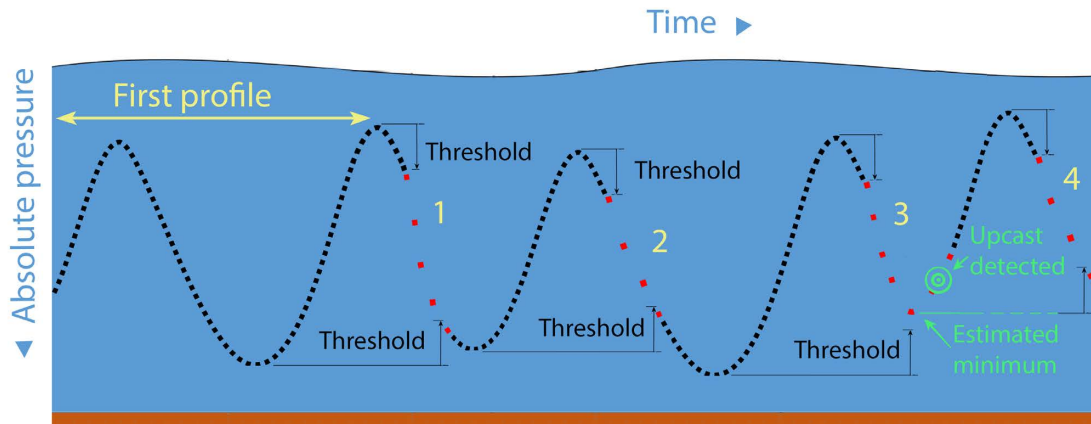

### Downcast 1

The instrument passes over its first maximum and reaches the threshold value. At this point, it switches to slow sampling (red dots).

**⚠** The first slow sample is recorded at the fast speed because it had already been scheduled by the time the instrument detected the threshold. The same will apply when the instrument switches back to the fast speed.

Slow sampling then continues until the threshold value (with respect to the first minimum) is detected. The instrument switches to slow sampling and soon begins to ascend.

### Downcast 2

The instrument passes over its second maximum and reaches the threshold value. It again switches to slow sampling (red dots).

Slow sampling then continues until the threshold value (with respect to the second minimum) is detected. The instrument switches to slow sampling, but this downcast turns out to be longer than the previous one and it descends much deeper before starting the next ascent.

### Downcast 3

The instrument passes over its second maximum and reaches the threshold value. It again switches to slow sampling (red dots).

Slow sampling then continues, but this time, the previous minimum was deeper, and the instrument the instrument begins to ascend before reaching the threshold value and thus, still sampling at the slow speed.

However, the instrument detects an upcast from pressure readings when the pressure drop of 3dbar is recorded. At this point, it switches to the fast sampling mode.

### Downcast 4

The instrument passes over its third maximum and reaches the threshold value. It again switches to slow sampling (red dots).

Slow sampling continues until the minimum threshold estimated from the detected upcast value is reached.

## 8.4.4 Tide

**Tide** sampling mode is similar to **Average**, as the instrument will also collect data at a certain rate, and then average those samples to produce a single value to store on the instrument. However, when set to **Tide**, the instrument uses averaging to remove wave noise data from pressure measurements.

**i** Both instruments with the | tide16 and | wave16 features support **Tide** sampling mode.

In addition to **Speed** and **Rate**, there are two more parameters required for **Tide** mode: **Duration** and **Interval**.

**Duration** specifies the time range over which to average. It must always be longer than **Speed**.

**Interval** is the repetition period for performing the averaging. It must always be longer than **Duration**.

There are two versions of sampling controls for **Tide** sampling mode: simple and advanced. Make your selections in **Preferences > General**.

### Simple sampling controls

When using the simple version, select **Speed**, **Duration**, and **Interval** from pre-defined options in three dropdown menus.

In the example shown, the sampling rate selected is 16Hz (16 samples per second). The instrument will be logging for a duration of one second, then pause and average the sixteen samples collected. After an interval of five minutes, it will start logging again, repeating the same cycle.

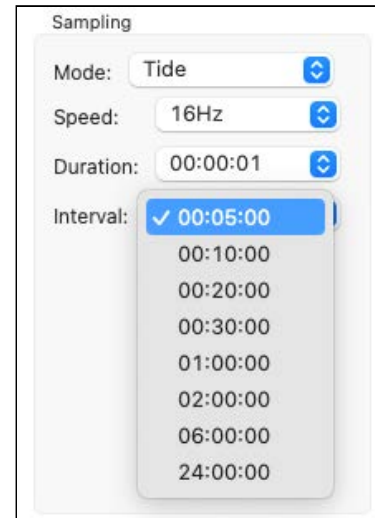

### Advanced sampling controls

When using the advanced version, select two or all three parameters manually.

All parameters are the same as in the previous example.

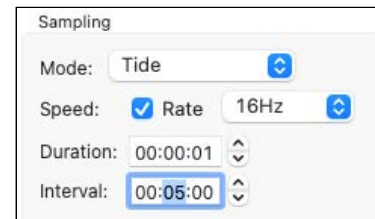

**i** At every **Interval**, the instrument records only one sample, averaged over all samples collected during the period of **Duration**. The rest of the samples are discarded after averaging is performed.

## 8.4.5 Wave

**Wave** sampling mode is similar to **Burst**, as the instrument will also collect a specified number of samples at a specified rate, and repeat this operation at a specified interval. When in **Wave** mode, the instrument takes multiple pressure readings in a burst and reconstructs the surface wave time series. This mode records both tide and wave information.

 Only instruments with the | wave16 feature support **Wave** sampling mode.

**Speed** or **Rate** are parameters defining individual pressure readings.

- The highest possible frequency visible in the data is limited to  $\frac{1}{2}$  the sampling rate. However, this mathematical limit cannot be achieved because of wave attenuation, and real data are actually lower.
- The sampling rate defines the resolution of the frequency spectrum which can be calculated from the wave data.
- The sampling rate, together with the burst duration, defines the lowest frequency which can be assessed in a wave burst.

In addition to **Speed** and **Rate**, there are two more parameters required for **Wave** mode: **Duration** and **Interval**.

**Duration** specifies the number of samples to record.

**Interval** is the repetition period for performing the burst. It must always be longer than the time it takes to obtain the number of samples indicated in **Duration**.

 Consider unique aspects of deployment environment when setting up **Wave** sampling mode. For example, while a 30-minute interval tends to work in most cases, shorter intervals may suit better when encountering ocean swells which have longer wavelengths than noise but shorter than tide.

Furthermore, you may enter **Instrument altitude** and **Mean depth of water** to estimate possible wave periods for your deployment. These parameters are not mandatory for the instrument to work, but allow you to get an idea of what to expect.

**Instrument altitude** is the actual height of the instrument in metres above the seabed. This is defined by deployment requirements, and the instrument must be physically affixed at this height during the installation.

- This parameter is stored on the instrument and used to compute wave statistics for pre-deployment analysis.

**Mean depth of water** is an estimate of the average water depth in metres, used for the initial prediction of wave frequency. It must always be greater than **Instrument altitude**.

- This parameter is not stored in the logger and only used to compute wave statistics. It is adjusted post-deployment through the RSK file.
- Ruskin will calculate the actual mean depth of water from the instrument altitude and its depth measured during the deployment.

There are two versions of sampling controls for **Wave** sampling mode: simple and advanced. Make your selections in **Preferences > General**.

### Simple sampling controls

When using the simple version, select **Speed**, **Duration**, and **Interval** from pre-defined options in three dropdown menus.

A common configuration is 4Hz sampling for 4096 samples every 30 minutes.

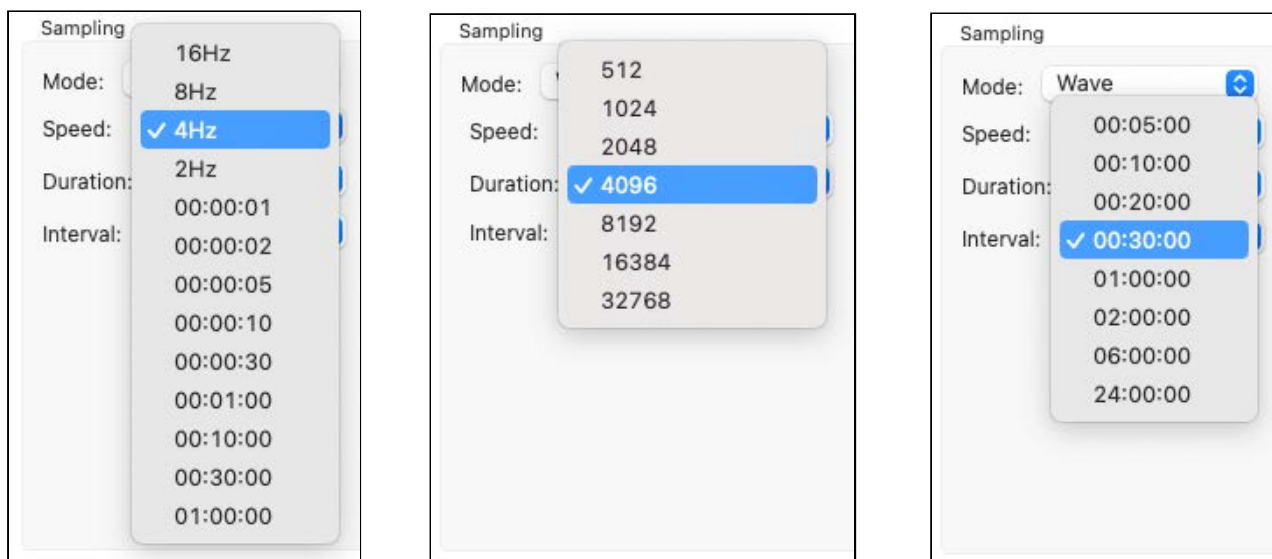

Enter **Instrument altitude** and **Mean depth of water** manually. Estimates for wave statistics will be immediately displayed: maximum wave frequency and minimum wave period (essentially, they reflect the same concept because  $\text{period} = 1/\text{frequency}$ ). These values can be adjusted post-deployment through the RSK file.

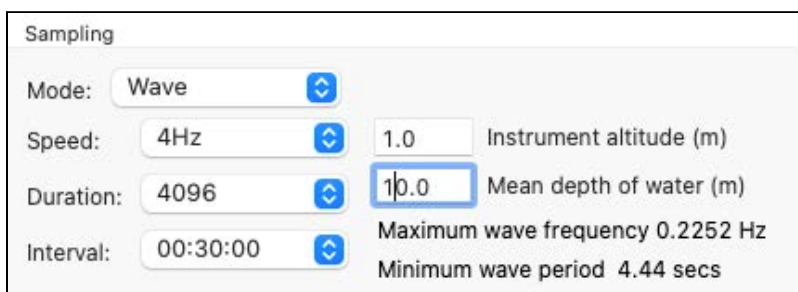

## Advanced sampling controls

When using the advanced version, enter all or some parameters manually.

This option allows more flexibility with your values. For example, with a rate of 4Hz and a duration of 4096 samples, the instrument will be sampling 17 minutes 4 seconds. You can set up near continuous sampling by setting the interval to 17:05. Logging will be on every second except the one remaining second of the interval, and then start again.

Sampling	
Mode:	Wave
Speed:	<input checked="" type="checkbox"/> Rate 4Hz
Duration:	4096
Interval:	00:17:05
	0.5 Instrument altitude (m)
	10.0 Mean depth of water (m)
	Maximum wave frequency 0.2183 Hz
	Minimum wave period 4.58 secs

- ✓ The timestamp of the burst for both **Tide** and **Wave** datasets is the beginning of the burst.

## Deployment depth of | wave16 instruments

- ✓ The basic rule is to place the instrument as close to the surface as possible without it emerging from the water due to large waves or low tides.

Attach your | wave16 instrument to a suitable support below the surface of the water, such as a dock or other rigid mooring, to completely immobilise it.

Enter the expected mean depth of water and the known instrument altitude (height above the seabed). From these values, Ruskin will estimate wave frequencies and wave periods that your instrument could measure (period = 1/frequency). On data retrieval, Ruskin will calculate the actual mean depth of water from the instrument altitude entered and its depth measured using the pressure transducer, and then use this actual depth for computing all wave statistics during deployment.

The physics of what a pressure transducer can measure depends on the height of water above as well as the depth of water below it. High frequencies attenuate very quickly with depth. The depth of the deployment is critical in determining frequencies/periods of the wave data the instrument will be able to capture. It is the depth, not orientation of the pressure transducer that affects these measurements.

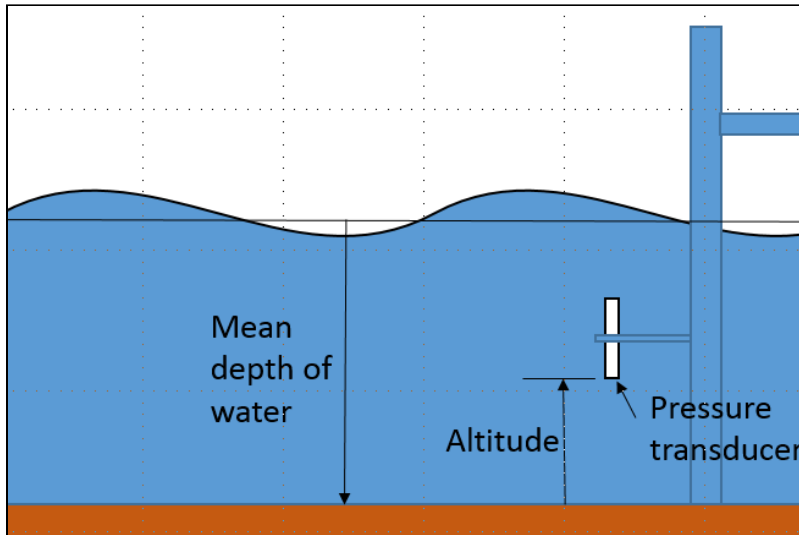

**Instrument fixed to a dock below the water surface**

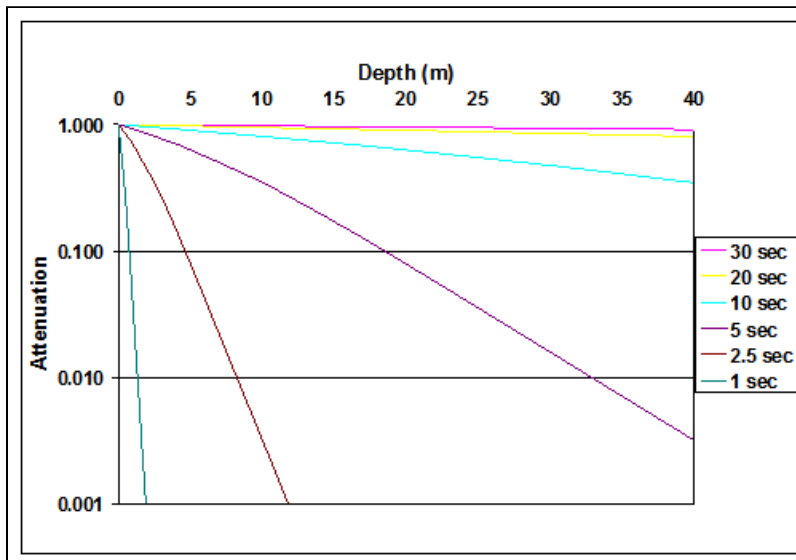

**Wave attenuation as a function of depth for various wave periods**

## 8.5 Gating

The **Gating** section allows you to enable your deployment using a method other than time-based. From the dropdown menu, select **Twist activation** to start your deployment by twisting the end-cap or **Marine wet switch** to enable the instrument based on contact with water. Otherwise, set it to **None** to use the specific **Start** time from the [Schedule](#) section.

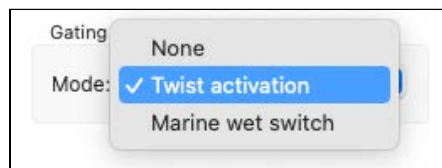



 The **Marine wet switch** option is only available for instruments with a conductivity sensor.

### Twist activation

When you select **Twist activation**, the instrument starts to sample based on the twist on/off position of its end-cap rather than a schedule.

To start sampling, first click **Enable**. This button is at the bottom of the **Configuration** tab.

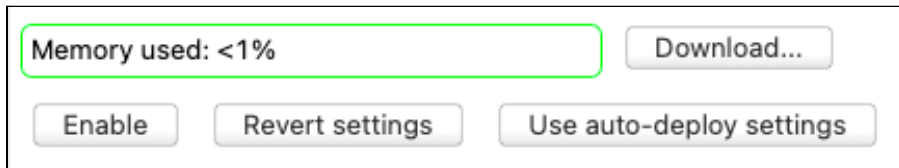

The button will then become a **Stop** button. The status will become "Logging paused".

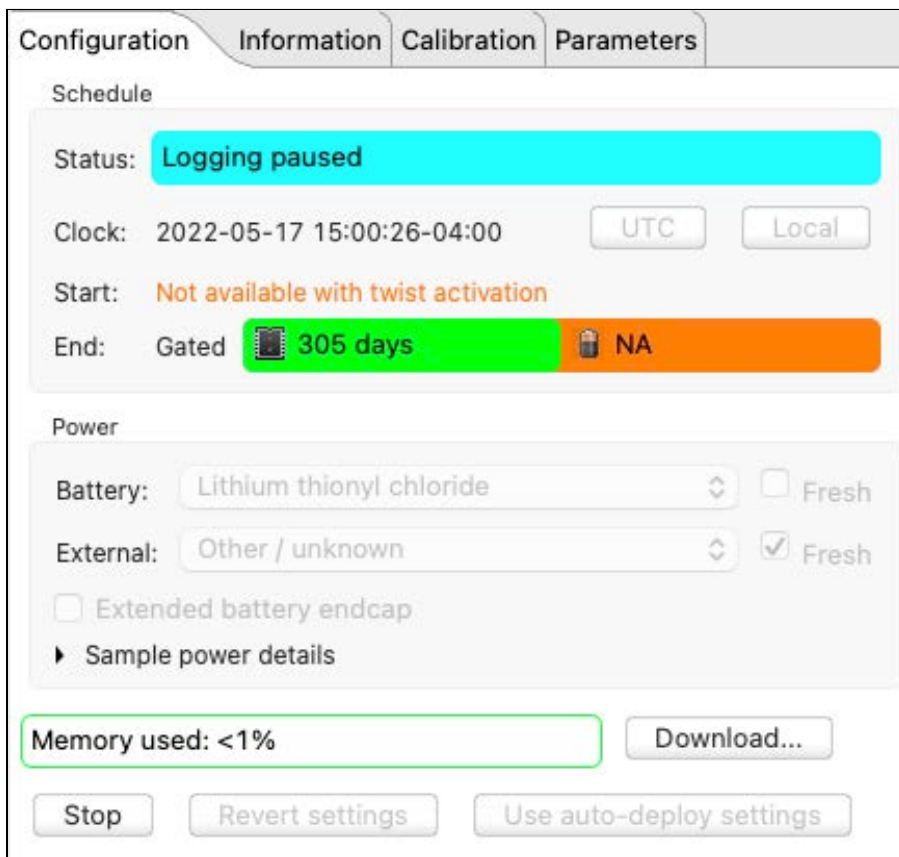

Turn the battery end-cap to the **RUN** position.  
The instrument will vibrate with one long pulse and start sampling.



To pause it, turn the battery end-cap to the **PAUSE** position. The instrument will vibrate with three short pulses to indicate it has stopped logging.



**⚠** Twisting the end-cap to the **RUN** or **PAUSE** position will activate the Wi-Fi. However, twisting to **PAUSE** will also pause the instrument. Twisting to **RUN** will resume sampling.

### Marine wet switch

When you select **Marine wet switch**, the instrument starts to sample as soon as it enters the water. This method is based on the conductivity sensor measurement.

To start sampling, first click **Enable**. The status will become "Logging paused". After that, the instrument will be checking the value on the conductivity sensor every 15 seconds. If it exceeds  $1\text{mS}/\text{cm}^2$ , the instrument will start logging and continue so until the conductivity values decrease below this threshold. Ruskin always updates with the correct state.

**⚠** The threshold value for **Marine wet switch** may not be suitable for freshwater applications as many freshwater sources would not exceed  $1\text{mS}/\text{cm}^2$ .

## 8.6 Options

The **Options** section offers additional settings for deploying your instrument.

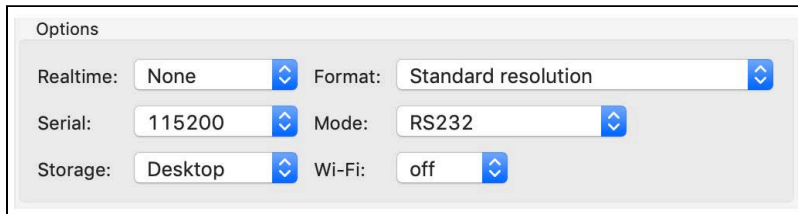

The screenshot shows the 'Options' panel with the following settings:

Field	Value
Realtime:	None
Format:	Standard resolution
Serial:	115200
Mode:	RS232
Storage:	Desktop
Wi-Fi:	off

### Realtime

Specify your external streaming connection. Select one of the three options:

- **None** to disable streaming to any external connection
- **Serial** to fetch or stream your data over an external underwater connection (RS-232 or RS-485).
- **USB** to fetch or stream your data over an external USB connection

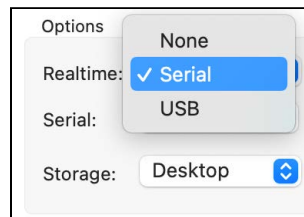

The screenshot shows the 'Realtime' dropdown menu with the following options:

- None
- Serial (checked)
- USB

If you select **None**, you disable streaming and enable fetching, provided you are still connected to the instrument via your internal USB port. Click the **Fetch** button  in the **Plot** view toolbar. The samples fetched from the instrument will be displayed on a live plot at the default speed of about one second. This collection rate is independent of the sampling speed configured in the instrument.

If you set **Realtime** to **Serial**, proceed to the **Mode** dropdown menu (see below) and select RS-232 or RS-485.

If you are interfacing to an external system that requires a control signal input, such as a modem with a DTR input, configure the parameters for the auxiliary output control signal from the instrument.

### Serial

Select the baudrate of the external serial connection. Factory baudrate is 9600.

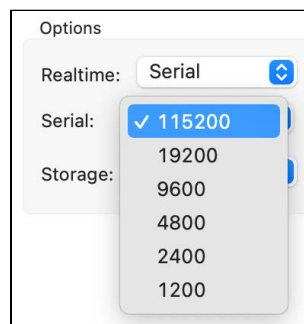

The screenshot shows the 'Serial' dropdown menu with the following options:

- 115200 (checked)
- 19200
- 9600
- 4800
- 2400
- 1200

## Storage

Select your deployment mode, which will determine the RSK file format. By default, new deployments started from a laptop or desktop computer are set to the **Desktop** storage format. However, if you enable Wi-Fi on your instrument or start your deployment from your mobile device, this option defaults to the **Mobile** storage format.

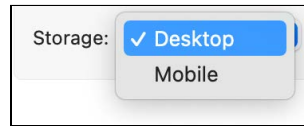

## Format

Select the **output format for the realtime data** from five dropdown options.

- **Standard resolution**  
All values are shown to four decimal places, with no units displayed.
- **Standard resolution (units)**  
All values are shown to four decimal places, with units displayed (after the number, separated by a space).
- **Highest resolution (RBRquartz)**  
All values are shown with enough significant digits ensuring no loss of resolution.
- **Engineering**  
All values are shown in engineering notation (same as scientific notation, but the exponent must be a multiple of three), with enough significant digits ensuring no loss of resolution.
- **Standard resolution (checksum)**  
All values are shown to four decimal places, with no units displayed. The output has the leading characters "RBR" and the serial number of the instrument, and a checksum (CRC) at the end, which can be used to validate that the transmission was successful.

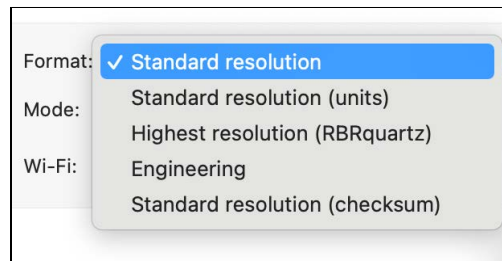

## Mode

Select from available external serial connections communication protocols: **RS-232**, **RS-485 FD**, **UART - (OEM)**, and **UART Idle low (OEM)**.

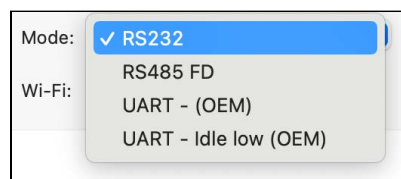

**⚠️ UART - (OEM), and UART Idle low (OEM) are for OEM customers only. Contact [RBR](#) if you have any questions.**

## Wi-Fi

Select "**on**" to allow your instrument to use the Wi-Fi module.

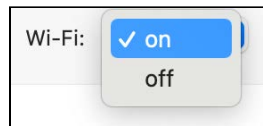

 This selection will not turn the Wi-Fi on or off. It is the instrument that controls the state of Wi-Fi.

## 8.7 Voltage sensors

The **Voltage sensors** section includes three fields: **Channel**, **Latency**, and **Current**. Ruskin uses these parameters to estimate deployment time (battery use) and to determine minimal sampling intervals.

The **Channel** field displays the sensor index on the instrument, for example, **4**. If there is more than one voltage sensor, select them from the dropdown list.

Use up and down arrows to change **Latency**. It specifies the wait time it takes the sensor to settle after powering up before it can take a reading. The units of measurement are milliseconds. Use up and down arrows to change this parameter.

Enter the **Current** value manually in the field provided. This is the sampling current required for the sensor to operate at a voltage of 12V. The units of measurement are milliamperes.

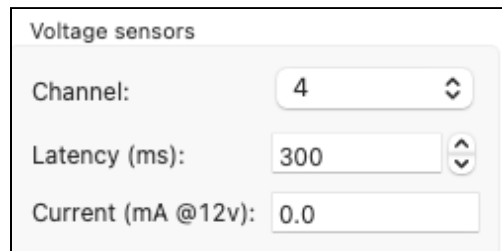
A screenshot of a configuration form titled 'Voltage sensors'. It contains three fields: 'Channel:' with a dropdown menu showing '4'; 'Latency (ms):' with a numeric input field showing '300' and up/down arrows; and 'Current (mA @12v):' with a numeric input field showing '0.0'.

 You must enter these parameters for sensors not supplied by RBR.

## 8.8 Ranging sensors

The **Ranging sensors** section has two dropdown menus, **Sensor** and **Range**.

The former displays the name and index of the channel, and the latter specifies the gain level used for the deployment. This parameter can be set to an auto-ranging setting or to a fixed gain setting. The fixed gain setting is specified by selecting one of the ranges specified.

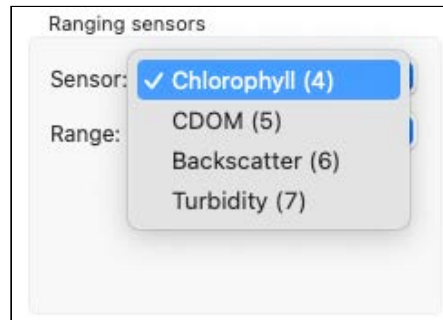

The former displays the name and index of the channel. Possible ranging sensors may be turbidity and fluorescence (chlorophyll or chlorophyll  $a$ , cDOM, backscatter).

The latter specifies the gain level used for the deployment. The units of measurement are NTU (Nephelometric Turbidity Units) for turbidity sensors,  $\mu\text{g/l}$  for chlorophyll, and counts for cDOM and backscatter.

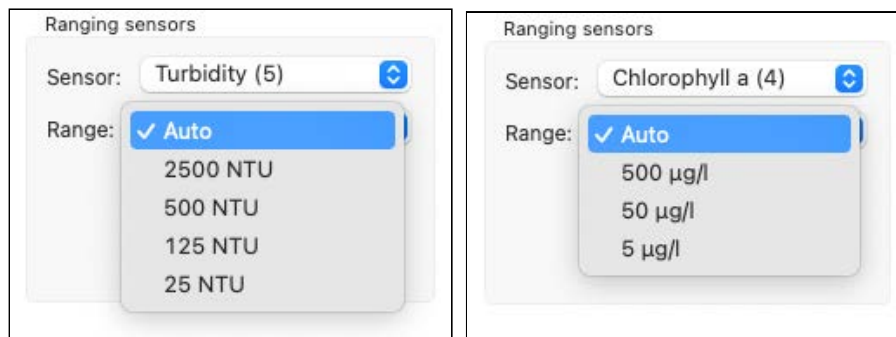

Set **Range** to **Auto** to enable the auto-ranging setting. Your instrument will change the gain setting on the front-end amplifiers to the range most appropriate for its environment. To display the range change events, select **Diagnostic**

from the dropdown under the **Events** button  in the **Plot** window toolbar.

Range change events are displayed as "RANGE XX Units" where XX indicates the current range and units are the units of measurement, for example: RANGE 500 NTU. For fast sampling, where the change may be occurring over a number of samples, the label will read, "RANGE CHG", followed by the final range change event.

Alternatively, select a fixed gain setting to maintain the same setting throughout your deployment.

## 8.9 Valve control

The **Valve control** section supports the RBR*quartz*<sup>3</sup> BPR | zero, which is the only RBR instrument with a switching valve. Properly setting the valve parameters improves deployment times.

The **Status** field displays the current valve position: **marine** or **atmospheric**. Toggle manually between these option using the **Set position** radio buttons.

The image shows three sequential screenshots of the 'Valve control' interface. In the first, the status is 'In atmospheric position', 'Set position' is 'atmospheric', and 'Schedule movement' is unchecked. In the second, the status is 'Moving to atmospheric position', 'Set position' is 'atmospheric', and 'Schedule movement' is unchecked. In the third, the status is 'In marine position', 'Set position' is 'marine', and 'Schedule movement' is unchecked. All three screenshots show 'Type' as 'Uniform', 'Skip first atmospheric duration' as unchecked, 'Duration' as 00:01, and 'Interval' as 0 01:00.

Select the **Schedule movement** checkbox to set the move to the atmospheric position for the deployment. Toggle the movement **Type** between **Uniform** and **Segmented**.

**Uniform** movement will activate controls for:

- **Duration**, the time to spend in the atmospheric position
- **Interval** the time between valve movements to the atmospheric position
- **Skip first atmospheric duration** option

This screenshot shows the 'Valve control' interface with 'Status: In marine position', 'Set position: marine' selected, and 'Schedule movement (00 00:01:00)' checked. 'Type' is set to 'Uniform', 'Skip first atmospheric duration' is unchecked, 'Duration' is 00:01, and 'Interval' is 0 01:00.

**Segmented** movement will activate controls for:

- **Segment**, with entry fields for **Selection** and **Count**
- **Delay**, the time to hold off before moving the the atmospheric position
- **Duration**, the time to spend in the atmospheric position
- **Interval**, the time between valve movements to the atmospheric position

This screenshot shows the 'Valve control' interface with 'Status: In marine position', 'Set position: marine' selected, and 'Schedule movement (00 00:01:00)' checked. 'Type' is set to 'Segmented', 'Segment: Selection' is 1, 'Count' is 1, 'Delay' is 0 00:00, 'Duration' is 00:01, and 'Interval' is 0 01:00.

 An external power source, such as RBR*fermata* or RBR*fermette*<sup>3</sup>, is required for valve operation.

## 8.10 Download

The **Download...** button is located next to the **Memory used** bar, at the bottom of the **Configuration** tab.

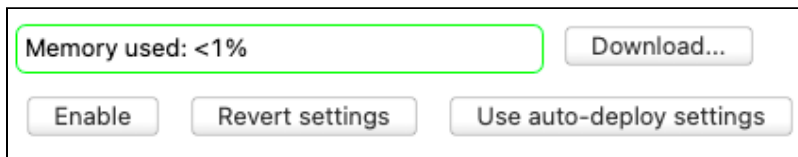

You can download data from your instrument at any time. However, it is especially important to do so when you stop a schedule. All the data on the instrument will be erased as soon as you enable a new deployment.

### Steps

1. Click the **Download...** button.  
A dialog box will appear.

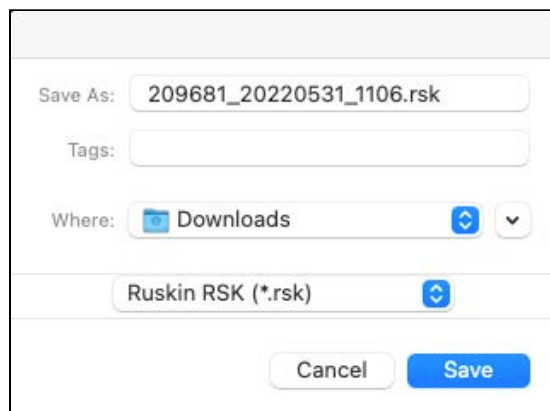

2. Enter a name for the data file in the **Save As** field, or accept the default name.  
By default, the RSK file name uses the Ruskin file naming convention (see [RSK files](#)).
3. Select the download location from the **Where** dropdown menu, or accept the default location.

**⚠** RBR recommends storing your data on a local drive rather than a network storage drive. Cloud storage options such as GoogleDrive and Dropbox may extend download times.



4. The new dataset will appear automatically in **Navigator** window under **Datasets**.

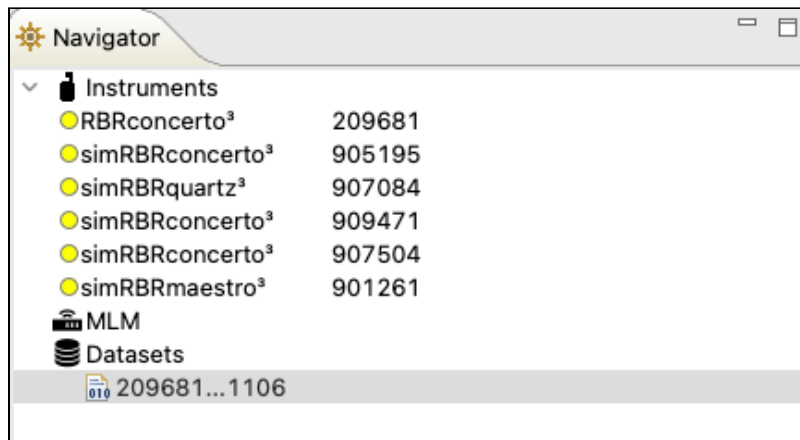

The **Properties** view will change to the new dataset, with the following tabs: **Analysis**, **Overview**, **Channels**, and **File info**.

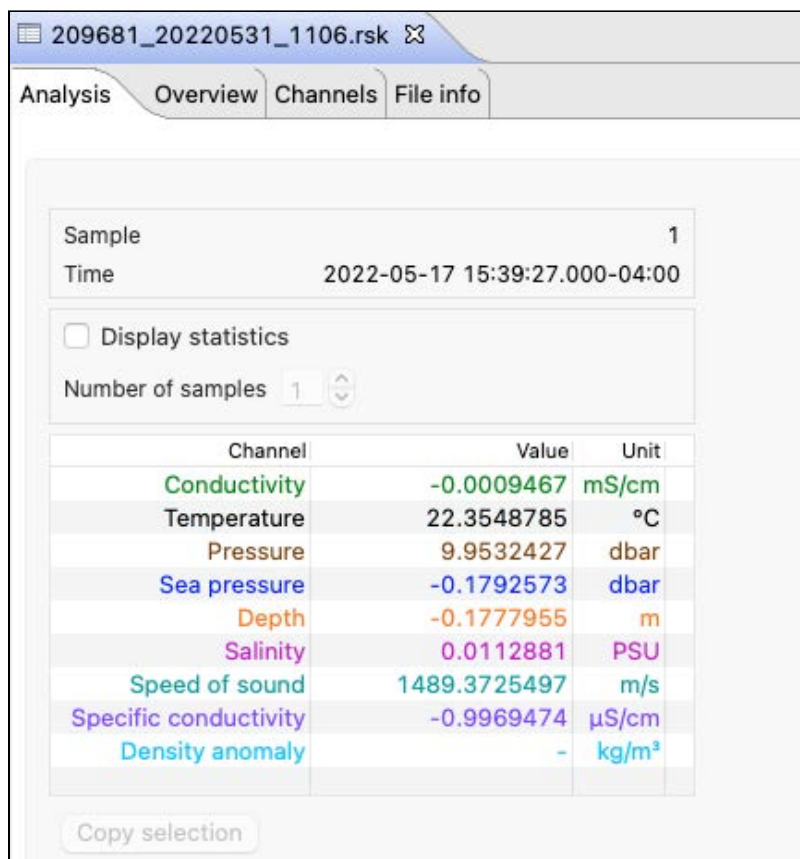

All the data stored on the instrument at the time of the download will be automatically plotted in the **Plot** window.

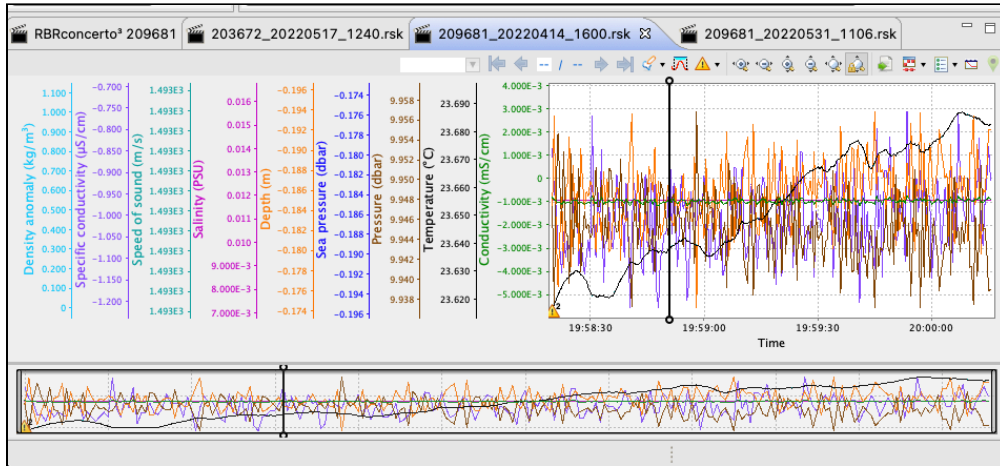

- When you download data again while on the same schedule, the RSK file will pick the same data and append it with any new data stored since the last download.

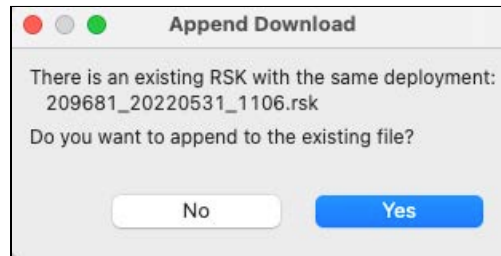

- Go to the **Overview** tab to add a comment for the download. Enter your message and click **Save comment**.

Analysis Overview Channels File info

File location  
/Users/jchapman/Downloads/209681\_20220531\_1106.rsk

Logger Model: RBRconcerto <sup>3</sup> Serial: 209681 Firmware: 1.141	Deployment Time offset: UTC-4:00 Time drift: -1867ms Deployment start time: 2022-05-17 15:39:00 First sample time: 2022-05-17 15:39:27 Last sample time: 2022-05-17 15:39:29 First event time: 2022-05-17 15:39:27 Last event time: 2022-05-17 15:39:31 Samples: 6	Continuous Period: 2 Hz Gate Gate: none
--	--	--

Markers

Errors: 0	Warnings: 1	Information: 2	Diagnostics: 0
-----------	-------------	----------------	----------------

Comment

Download 2

Save comment

## 8.11 Use auto-deploy settings

When working with a large number of similar instruments, Ruskin offers various **automatic tasks**, which can be set up from the **Instruments** menu on the top toolbar.

This feature may be convenient when you need to deploy several instruments with the same sampling capabilities. Select an instrument to use as the model and **configure** it. This will be your model schedule. Verify that these settings meet your requirements and all values are entered correctly.

- ✓ To confirm which auto-deploy parameters are set on Ruskin, go to **Instruments > View auto-deploy settings...** . The **Auto-deploy settings** box will open, with saved parameters outlined.

When you connect to an instrument with same sampling capabilities as the model instrument, Ruskin will configure it to match the the model schedule.

If your were connected to an instrument before setting up your model schedule, you can click **Use auto-deploy settings** to apply them to that previously connected instrument.

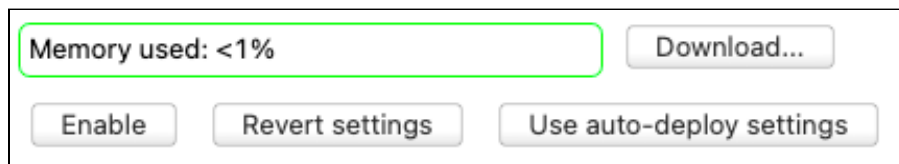

Click **Revert settings** when you wish to return to a previously configured schedule.

- ⚠ You cannot use **Revert settings** after clicking **Enable**. To change a schedule already enabled, stop the instrument, restore old values manually, and click **Enable** again.

Enable each instrument individually to start deployments.

## 8.12 Enable / Stop

Ensure that your instrument is ready to be deployed before enabling a schedule. See [Deploy your instrument](#).

To allow the instrument to start logging, click **Enable**. This button is at the bottom left of the **Configuration** tab.

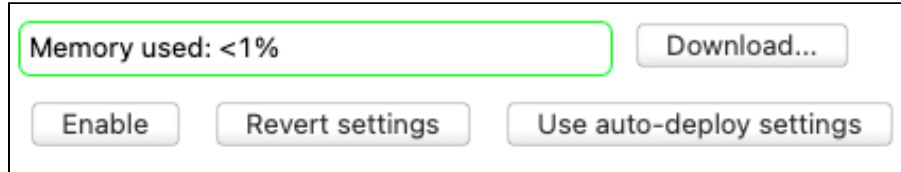

The **Enable** button will now read **Stop**. The status will become "Logging paused", "Schedule enabled", or "Logging", depending on the configuration.

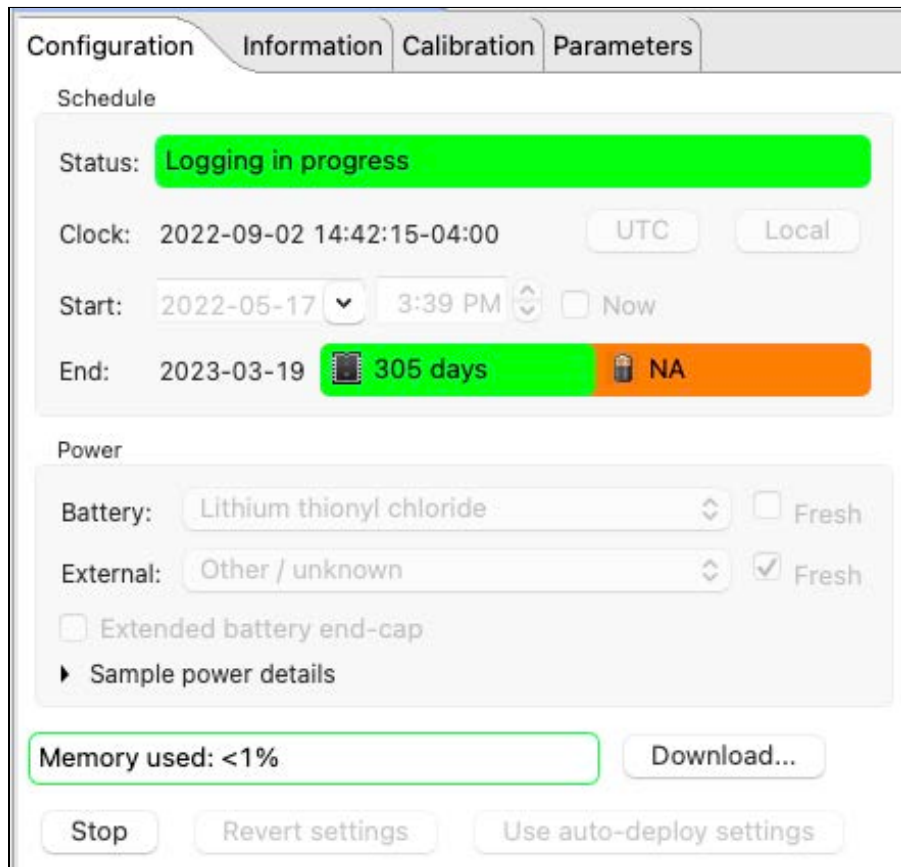

Logging will start when one of the following occurs:

- The **Now** button is checked
- The **Start** time arrives
- The **Gating** condition for starting is met

If you click **Enable**, and the instrument memory is not empty, you will see a warning.

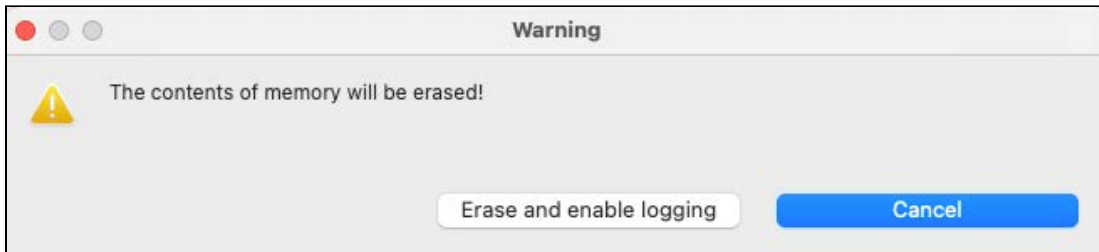

Before proceeding, download the data from your instrument (see [Download](#)). If you are sure that the information is saved or not needed, click **Erase and enable logging**.

**⚠** All editable fields become greyed out after you enable a schedule. To change any deployment parameters, stop your instrument, adjust the settings, and start a new deployment.

To manually stop the instrument, click **Stop**.

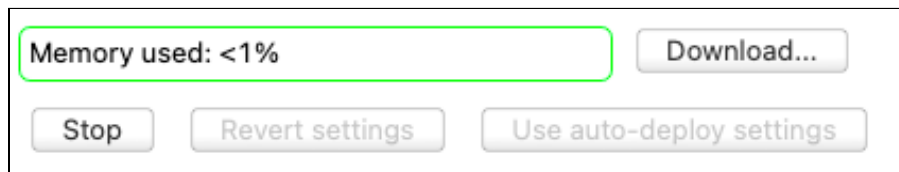

Logging will stop on its own when one of the following occurs:

- The **End** logging time is reached
- The **Gating** condition for stopping is met
- The power source is removed or depleted
- The memory is filled

## 9 Information

Use the **Information** tab to view general information for each of your instruments, such as as model, generation, serial number, firmware version, power source, and the channels.

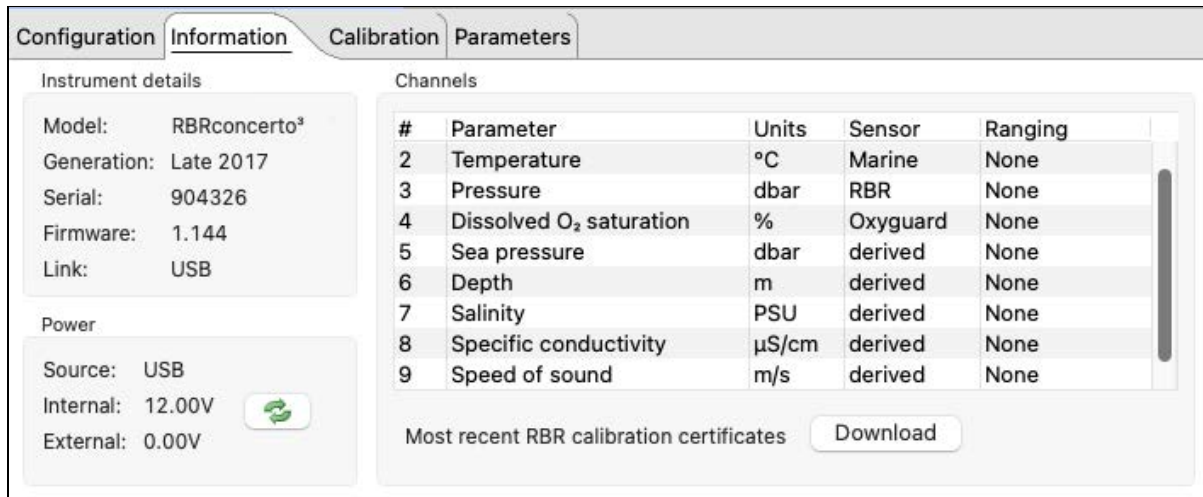

The screenshot shows the 'Information' tab of an RBR instrument interface. It is divided into two main sections: 'Instrument details' and 'Channels'.

**Instrument details:**

- Model: RBRconcerto<sup>3</sup>
- Generation: Late 2017
- Serial: 904326
- Firmware: 1.144
- Link: USB

**Power:**

- Source: USB
- Internal: 12.00V (with a battery icon)
- External: 0.00V

**Channels:**

#	Parameter	Units	Sensor	Ranging
2	Temperature	°C	Marine	None
3	Pressure	dbar	RBR	None
4	Dissolved O <sub>2</sub> saturation	%	Oxyguard	None
5	Sea pressure	dbar	derived	None
6	Depth	m	derived	None
7	Salinity	PSU	derived	None
8	Specific conductivity	µS/cm	derived	None
9	Speed of sound	m/s	derived	None

At the bottom of the Channels section, there is a link for 'Most recent RBR calibration certificates' and a 'Download' button.

In the **Instrument details** section, find the model, generation, and serial number for your instrument, as well as the firmware version installed and link used.

Refer to the **Power** section for the power source, power type (internal or external), and voltage.

The voltage value indicated for the internal source indicates the power remaining in your batteries.

Please note that the power drop in lithium batteries is very sharp, so it may not be a good idea to rely on this indicator to predict battery life. However, it is quite reliable for alkaline batteries.

Under **Channels**, confirm measured and derived parameters for your instrument.

# 10 Calibration

The **Calibration** tab displays calibration coefficients for each parameter, and the date and time of the last calibration. Select a sensor from the **Parameter** dropdown menu to display its calibrations.

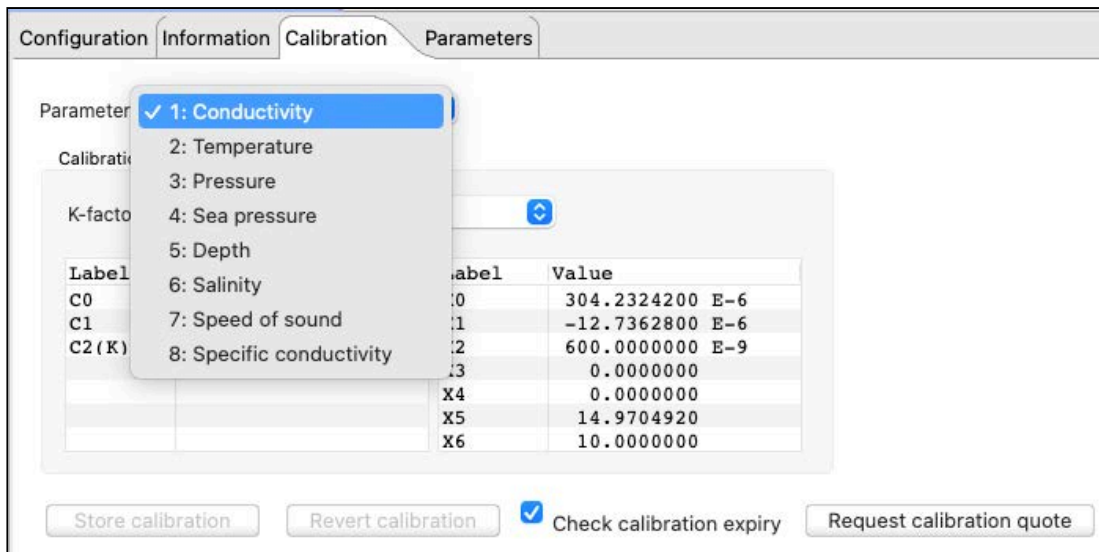

RBR calibration certificates contain calibration equations, coefficients, and residuals for each sensor.

The date of the latest calibration is always displayed. As an extra reminder, you can select the **Check calibration expiry** checkmark. A warning sign will appear when your calibration certificate is out of date.

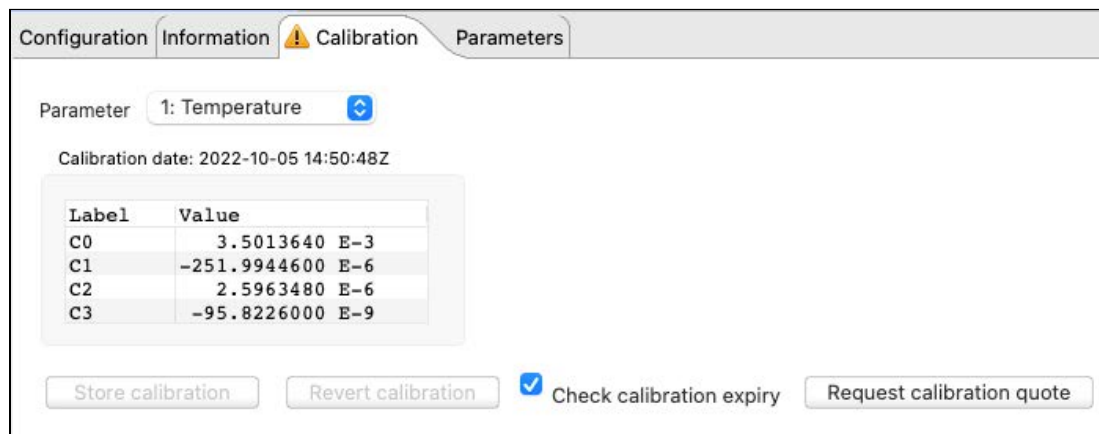

RBR recommends calibrating your instrument before any critical deployment, periodically once a year, or if you suspect the readings to be out of specifications.

Discuss your calibration requirements with RBR. In some cases, the instrument may need to be returned to RBR to have it checked and re-calibrated.

To contact RBR for our current calibration fees, click **Request calibration quote**. A **Request for quote** dialog box will appear.

**Request for quote**

⊗ All contact details must be specified.

Contact details

Name:  Address:

Email address:

Phone:

Organization:

Sensor list:

Conductivity  
 Temperature  
 Pressure

Other information:  
 Enter a longer description here.

Request preview:

Request for calibration quote: RBRconcerto<sup>3</sup> 209681

Requested sensor calibrations:  
 Conductivity

Cancel Submit

Verify that all information is correct and click **Submit**.

### Simple calibration controls

When using the simple version, you will be able to view and edit only the main calibration coefficients, displayed as "C" values: C0, C1, C2, C3.

Configuration Information Calibration Parameters

Parameter: 3: Pressure

Sensor serial number: N122080

Calibration date: 2022-02-03 19:17:57Z

Label	Value
C0	-38.4045200
C1	2.3795940 E3
C2	27.9242860
C3	-27.3828380

Store calibration Revert calibration  Check calibration expiry Request calibration quote



## Advanced calibration controls

When advanced calibration controls are enabled in **Preferences > General**, you will be able to view and edit both main and dependent coefficients. Dependent coefficients are displayed as "X" values: X0, X1, X2, etc.

The screenshot shows the 'Calibration' tab in the 'Parameters' section. The parameter is set to '3: Pressure'. The sensor serial number is 'N122080' and the calibration date is '2022-02-03 19:17:57Z'. Below this is a table of coefficients:

Label	Value	Label	Value
C0	-38.4045200	X0	10.1991000
C1	2.3795940 E3	X1	74.3307120 E-3
C2	27.9242860	X2	25.4226000 E-6
C3	-27.3828380	X3	-2.1752340 E-6
		X4	-71.7971840 E-6
		X5	20.1043360

At the bottom, there are four buttons: 'Store calibration', 'Revert calibration', 'Check calibration expiry' (checked), and 'Request calibration quote'.

You can edit the coefficients. As soon as you make a change and move to another cell, a new calibration date will be displayed. Also, **Store calibration** and **Revert calibration** buttons will become active.

The screenshot shows the same 'Calibration' tab, but with the 'C0' value edited to '-38.4045000'. The calibration date has updated to '2022-06-14 19:25:59Z'. The 'Store calibration' and 'Revert calibration' buttons are now active. The 'Check calibration expiry' checkbox remains checked.

Label	Value	Label	Value
C0	-38.4045000	X0	10.1991000
C1	2.3795940 E3	X1	74.3307120 E-3
C2	27.9242860	X2	25.4226000 E-6
C3	-27.3828380	X3	-2.1752340 E-6
		X4	-71.7971840 E-6
		X5	20.1043360

Use **Store calibration** to save the new values.

**!** Always click **Store calibration** to save new coefficients on the instrument. Otherwise, all changes will be lost once your session is closed.

Use **Revert calibration** to recover to the original coefficients if you have not already saved your changes to the instrument.

**!** You cannot use **Revert calibration** after clicking **Store calibration**. Once the coefficients are saved to the instrument, you will need to restore old values manually and save them again.

# 11 Parameters

The **Parameters** tab displays all the parameters the RBR instrument may need for calculating derived channels.

If your instrument can measure a parameter, it will use the measured value. Otherwise, you can enter the necessary values manually, and they will take effect immediately.

For example, you always need atmospheric pressure and water density for derivation of depth. Default values in Ruskin correspond to sea level and sea water. Therefore, it is especially important to adjust these parameters when working at high altitudes in fresh water.

Enter atmospheric pressure (in dbar) and water density (in g/cm<sup>3</sup>) manually in the table under the **Parameter** tab. If not entered, default values of 10.1325dbar and 1.0281g/cm<sup>3</sup> will be used.

Configuration	Information	Calibration	Parameters
Temperature (°C)			<input type="text" value="15.0"/>
Pressure (dbar)			<input type="text" value="10.1325"/>
Atmospheric pressure (dbar)			<input type="text" value="9.7700"/>
Density (g/cm <sup>3</sup> )			<input type="text" value="1.0000"/>
Specific conductivity coefficient			<input type="text" value="0.0191"/>
Average sound speed (m/s)			<input type="text" value="1550.744"/>
Salinity (PSU)			<input type="text" value="35.0"/>
*Parameters take effect immediately			

## 12 Preferences

On your Mac, access **Preferences** from the **Ruskin** dropdown menu in the top toolbar.

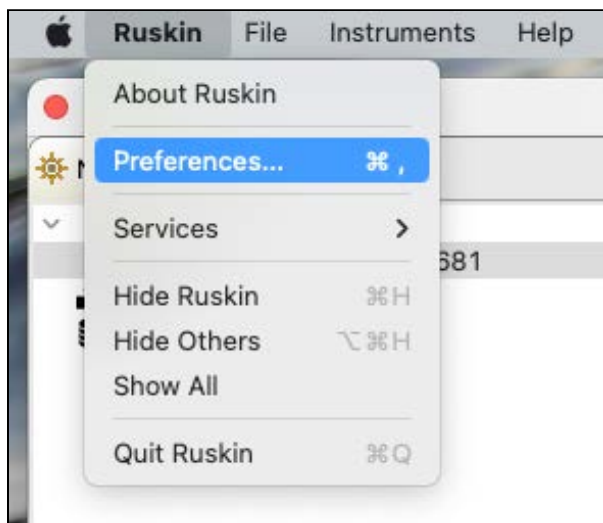

On your Windows PC, use the **Options** dropdown menu to set up your preferences.

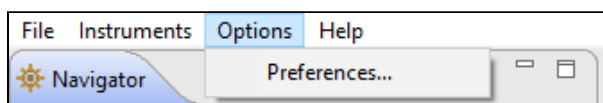

Factory-set global defaults require no changes in most situations. However, as you learn more about what Ruskin can do, you may want to change some of these settings to better suit your requirements. The global preferences include:

- Derived channels (applies to some legacy instruments)
- Facility (authorised users only, requires login)
- General (download locations and options, sampling and calibration controls, export options)
- Plotting (channel visibility and channel colours)

### 12.1 Derived channels

**⚠** The **Derived channels** settings are intended for XR(X),1060, 2050, and 1050 RBR legacy data loggers. They do not apply to newer generations. They do not apply to any RBRcoda or RBRcoda<sup>3</sup> instruments. Newer generations calculate all possible derived channels for that specific instrument. Use the [Parameters](#) tab in the instrument **Properties** window to set up initial parameters for calculating derived channels. For downloaded files, use the [Parameters](#) tab in the dataset **Properties** window.

The **Derived Channels** section of the **Preferences** dialog box has four tabs: **Depth**, **Conductivity - Salinity**, **Dissolved O<sub>2</sub>**, and **No sensor values**, where you can choose additional channels derived from measured channels.

Derived channels calculated by the instrument as well as those calculated by Ruskin are automatically added to the default channel list in both the live **Plot** view and the static dataset.

## Depth

If your instrument has a pressure channel, you can use its measurements to derive a depth channel. The data calculated for this derived channel appear along with measured channels in the **Plot** view and in datasets.

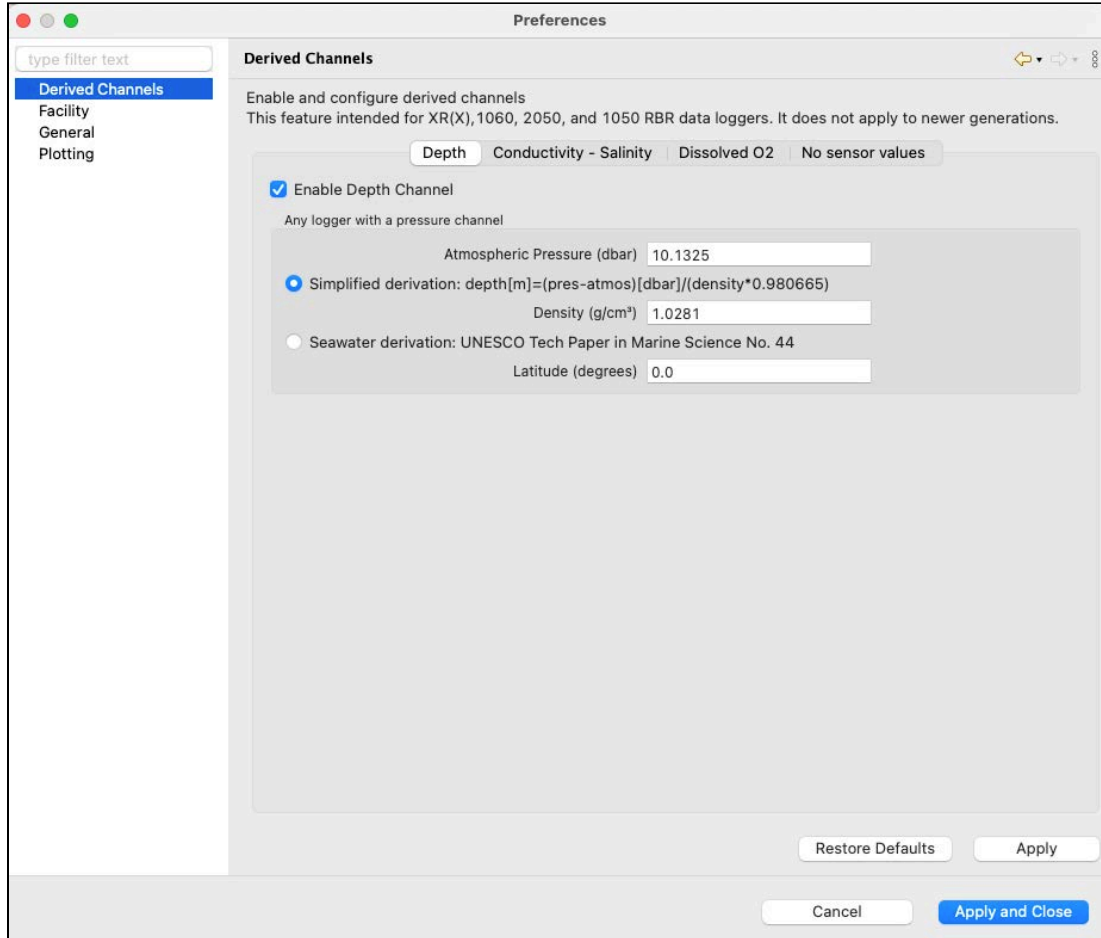

1. Select the **Enable Depth Channel** checkbox.

 For newer generation instruments, all derived channels are calculated regardless of the checkbox status.

2. In the **Atmospheric Pressure** box, type the value in dbar or use the default value. This value corrects the pressure measurements during the depth calculation.

 The default **Atmospheric Pressure** value is 10.1325. Adjust this value manually to represent a different altitude.

3. Select either the **Simplified calculation** or **Seawater calculation**.

 Ruskin can calculate depth based on the simplified calculation or the UNESCO seawater calculation. The instrument always calculates depth using the simplified calculation.

- a. To use the simplified calculation, type the actual water density, or use the default value. Note that for freshwater, the density should be set to 1.0.
- b. To use the UNESCO seawater calculation, specify the latitude of the data collection in degrees and minutes.

## Conductivity - Salinity

If your instrument has a conductivity channel, you can use its measurements to derive salinity, density anomaly, specific conductivity, and speed of sound.

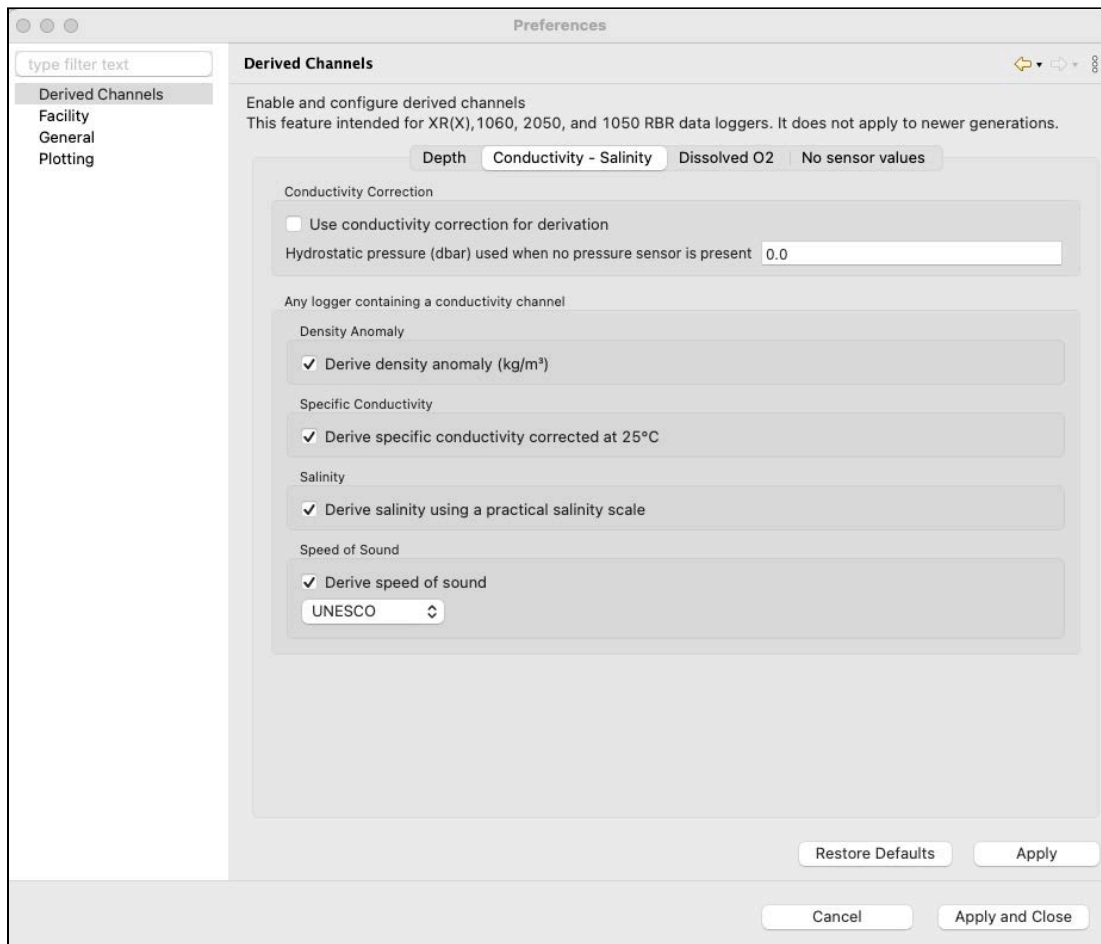

1. Select the **Use conductivity correction for derivation** checkbox.

**⚠** For newer generation instruments, all derived channels are calculated regardless of the checkbox status.

2. In the **Hydrostatic pressure** box, type the value in dbar or use the default value.
3. Select derived channels to include in your calculations.
4. For the speed of sound, select between UNESCO, Del Grosso, and Wilson equations.

## Dissolved O<sub>2</sub>

You can derive a dissolved oxygen channel that measures oxygen saturation as a percentage.

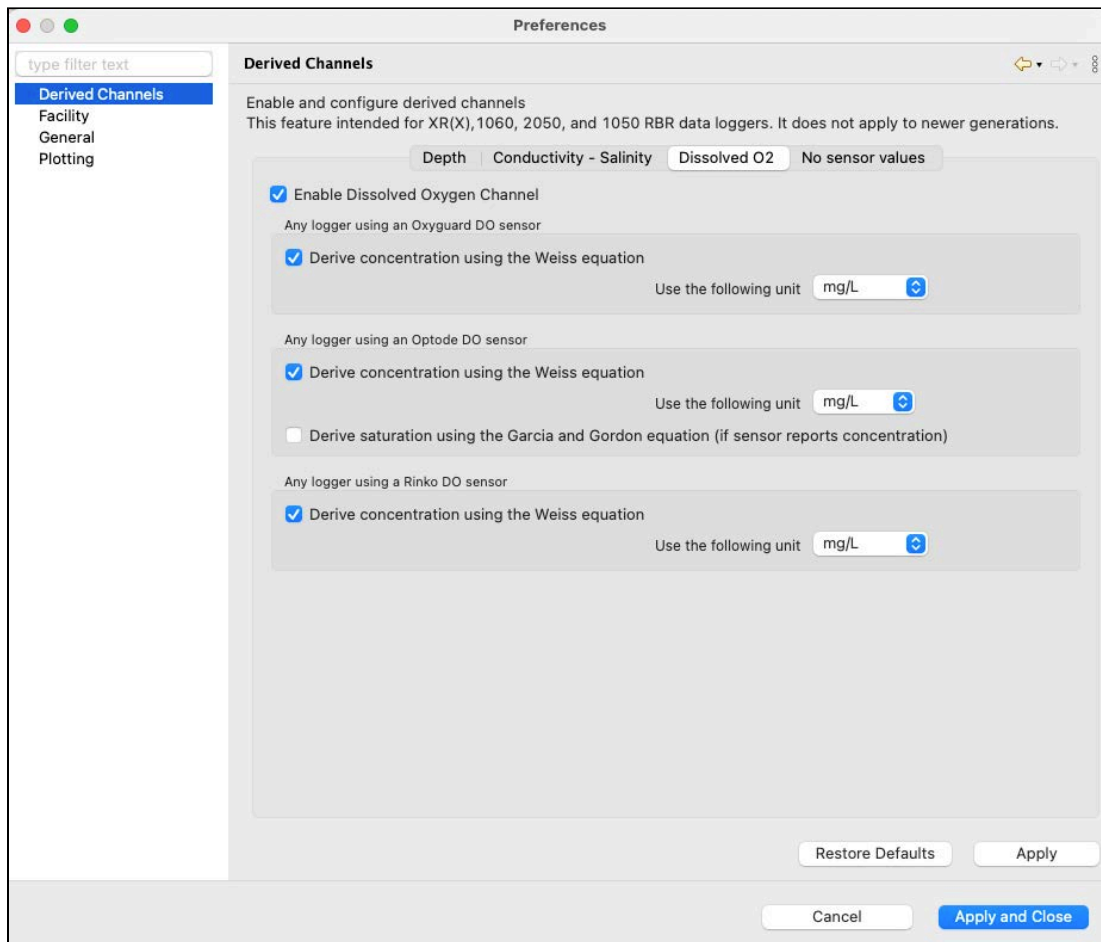

1. Click the **Dissolved O<sub>2</sub>** tab and select the **Enable Dissolved Oxygen Channel** checkbox.

**⚠** For newer generation instruments, all derived channels are calculated regardless of the checkbox status.

2. If your instruments use the Oxyguard DO or RINKO DO sensor, select the **Derive concentration using the Weiss equation** checkbox and the output unit:  $\mu\text{Mol/L}$ , mg/L, or mL/L.

**⚠** The Weiss equation requires values for temperature and salinity. If your instrument does not measure them, you can specify standard values on the **No sensor values** tab.

3. If your instruments use the Aanderaa Optode DO sensor to measure oxygen saturation, select the **Derive concentration using the Weiss equation** checkbox and the output unit: mg/L or mL/L.

- If any of your instruments use the Aanderaa Optode DO sensor to measure oxygen concentration, select the **Calculate saturation using the Garcia and Gordon equation** checkbox.

**⚠** The Garcia and Gordon equation requires values for temperature and salinity. If your instrument does not measure them, you can specify standard values on the **No sensor values** tab.

### No sensor values

Enter salinity, pressure, and temperature values used to calculate the derived channels when a sensor is not available.

The screenshot shows a 'Preferences' window with a sidebar on the left containing 'Derived Channels', 'Facility', 'General', and 'Plotting'. The main area is titled 'Derived Channels' and contains a sub-section 'No sensor values'. This sub-section has three input fields: 'Salinity (PSU) to be used when no conductivity sensor is present' with a value of 35.0, 'Hydrostatic pressure (dbar) to be used when no pressure sensor is present' with a value of 0.0, and 'Temperature (°C) to be used when no temperature sensor is present' with a value of 0.0. At the bottom of the window are buttons for 'Restore Defaults', 'Apply', 'Cancel', and 'Apply and Close'.

**⚠** If you suspect that the derived channel value is incorrect, check to make sure that the **No sensor values** entries match the deployment environment. For example, if a dissolved oxygen saturation measurement is made in a lake at 8°C but the **No sensor values** salinity is 35 and the temperature is 15°C, concentration reported will be incorrect. Adjust the **No sensor values** entries and recompute.

## 12.2 General

Use the **General** preference page to set up file locations, language, download options, sampling and calibration controls, and export options.

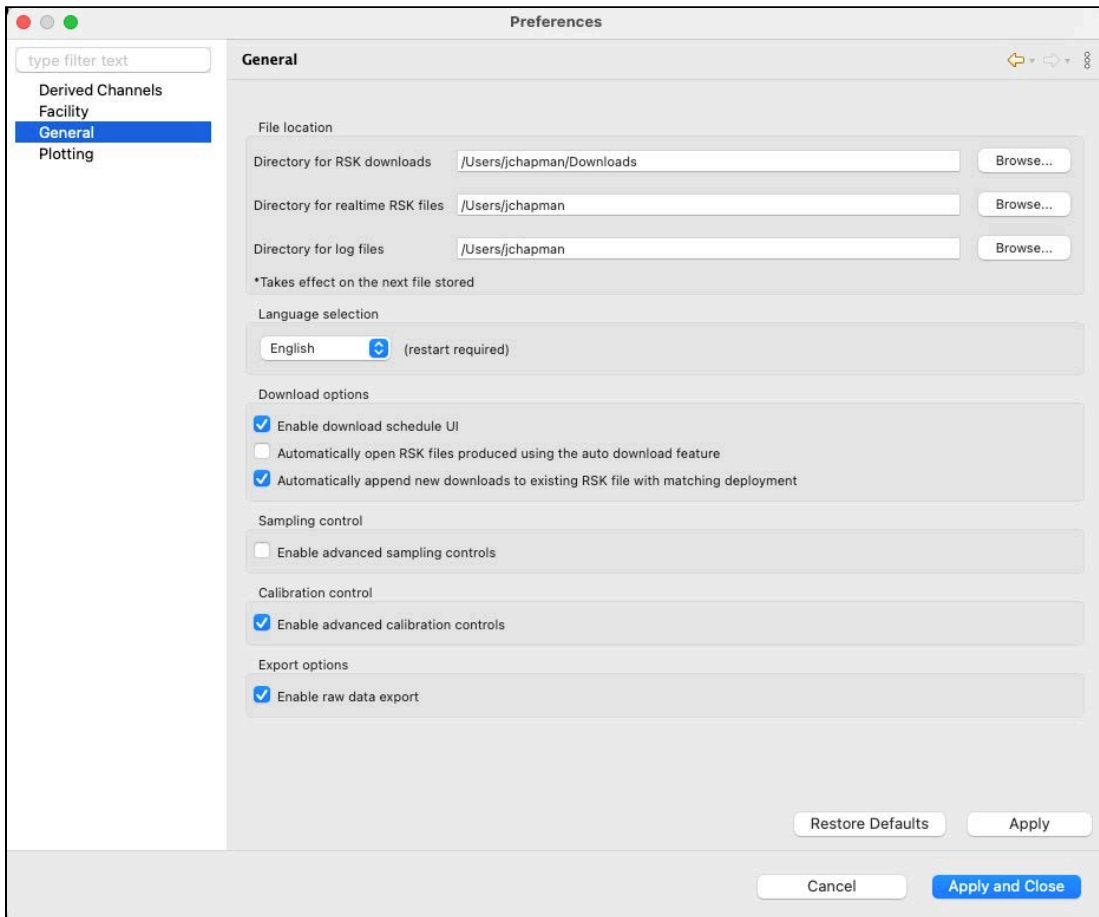

✔ You can click **Apply** to save your changes without closing the dialogue box.

### File location

You can control where RSK files, realtime RSK file, and log files are stored by default.

Specify these locations before downloading any data by typing in a directory name or by browsing.

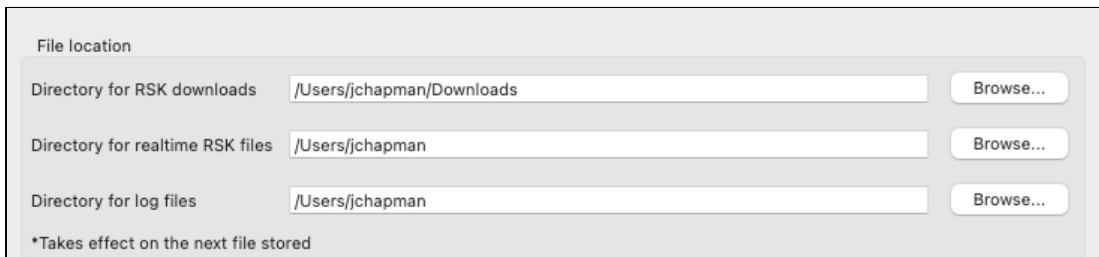



RSK files are the datasets obtained from your instrument.

Realtime RSK files are generated when a connected instrument is streaming or when you enable fetching mode on the instrument.

Log files are generated by Ruskin and help when diagnosing issues. These files are automatically attached to issues generated using the **Comment on Ruskin** feature.

**⚠** RBR recommends storing your datasets on a local drive rather than a network storage drive. Cloud storage options such as GoogleDrive and Dropbox may extend download times.

You can change where future files are stored by default at any time. When done, click **Apply** or **Apply and close**. The changes will take effect immediately.

### Language selection

Ruskin is available in six languages: English, French, Spanish, Simplified Chinese, Korean, and Japanese.



Select your language from the dropdown menu and click **Apply** or **Apply and close**. Ruskin will need to restart for the changes to take effect.

### Download options

Select the appropriate checkboxes to change your download preferences.

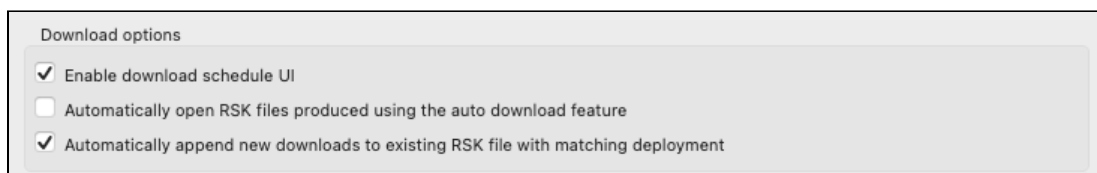

**⚠** The **Enable download schedule UI** checkbox is only for legacy instruments.

When done, click **Apply** or **Apply and close**. The changes will take effect immediately.

### Sampling control

Select the checkbox to enable advanced controls when setting up your sampling options.



The screenshot shows a rectangular panel titled "Sampling control". Inside the panel, there is a single checkbox labeled "Enable advanced sampling controls" which is checked with a blue checkmark.

With simple controls, you will select **Speed**, **Duration**, and **Interval** from pre-defined options in three dropdown menus. When advanced controls are enabled, you will be able to enter these parameters manually and achieve a more precise setting.

When done, click **Apply** or **Apply and close**. The changes will take effect immediately.

### Calibration control

Select the checkbox to enable advanced controls when setting up your calibration options.



The screenshot shows a rectangular panel titled "Calibration control". Inside the panel, there is a single checkbox labeled "Enable advanced calibration controls" which is checked with a blue checkmark.

With simple controls, you will be able to view and edit only the main coefficients (C). When advanced controls are enabled, you will be able to view and edit all main and dependent calibration coefficients (C, X) for any channel.

When done, click **Apply** or **Apply and close**. The changes will take effect immediately.

### Export options

Select the checkbox to enable raw data export. Use this option for downloading your RSK file when storage space is limited or expensive. The dataset will be exported in the most compact raw binary format.

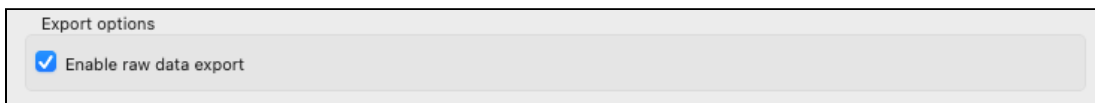

The screenshot shows a rectangular panel titled "Export options". Inside the panel, there is a single checkbox labeled "Enable raw data export" which is checked with a blue checkmark.

When done, click **Apply** or **Apply and close**. The changes will take effect immediately.

## 12.3 Plotting

Adjust default settings for the graphical display in the **Plot** view. Manage selections in **Channel visibility** and **Channel colours**, and apply them globally.

✔ You can click **Apply** to save your changes without closing the dialogue box.

### Channel visibility

The **Channel visibility** tab displays many options to hide or show specific information.

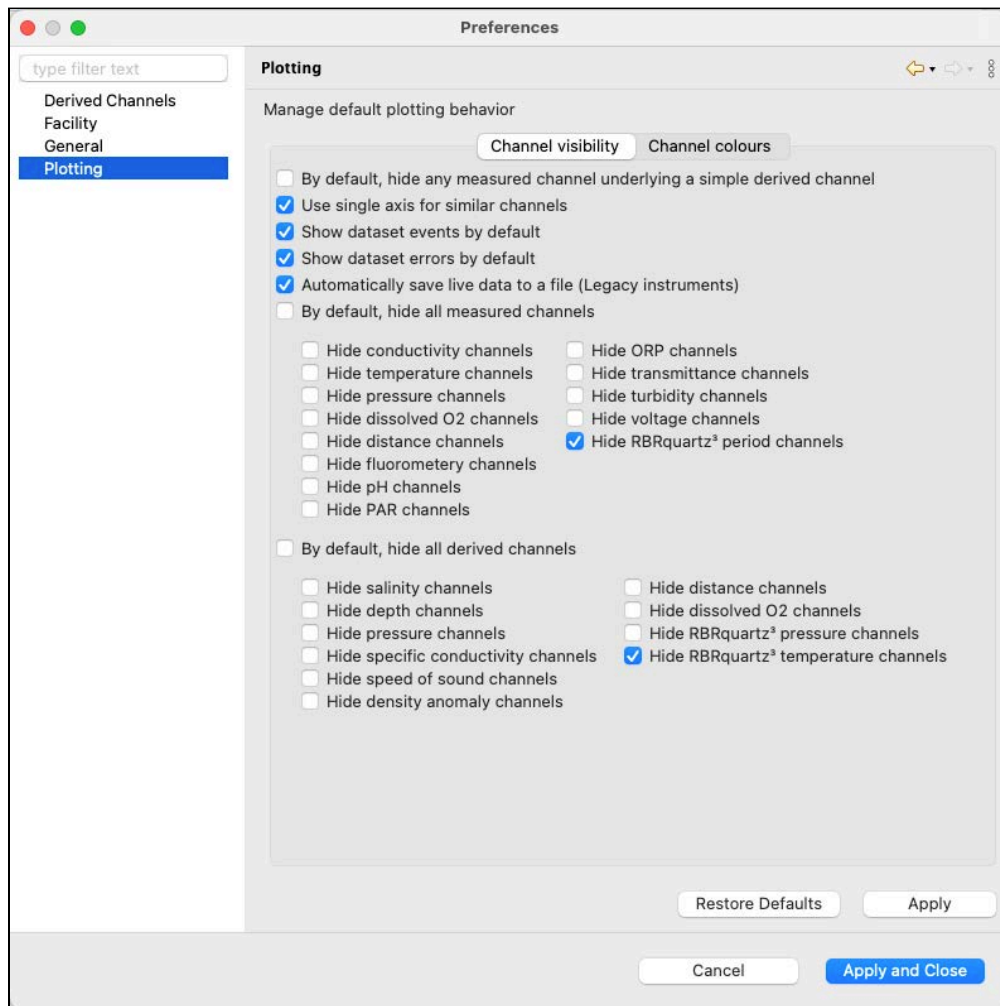

Opt for displaying errors and events for a more informative graph, or hide them for a cleaner view.

Select the **By default, hide all measured channels** checkbox to display only derived channels.

Select the **By default, hide all derived channels** checkbox to display only measured channels.

Otherwise, pick and choose channels to display or hide.

When done, click **Apply** or **Apply and close**. The changes will take effect immediately.

 You can override visibility preferences in the **Plot** view for any particular graphical display.

### Channel colours

The **Channel colours** tab allows you to choose a different colour for each channel that is shown for information currently running in **Plot** view, or from an opened dataset. Select from the list of pre-defined options or create your own colour.

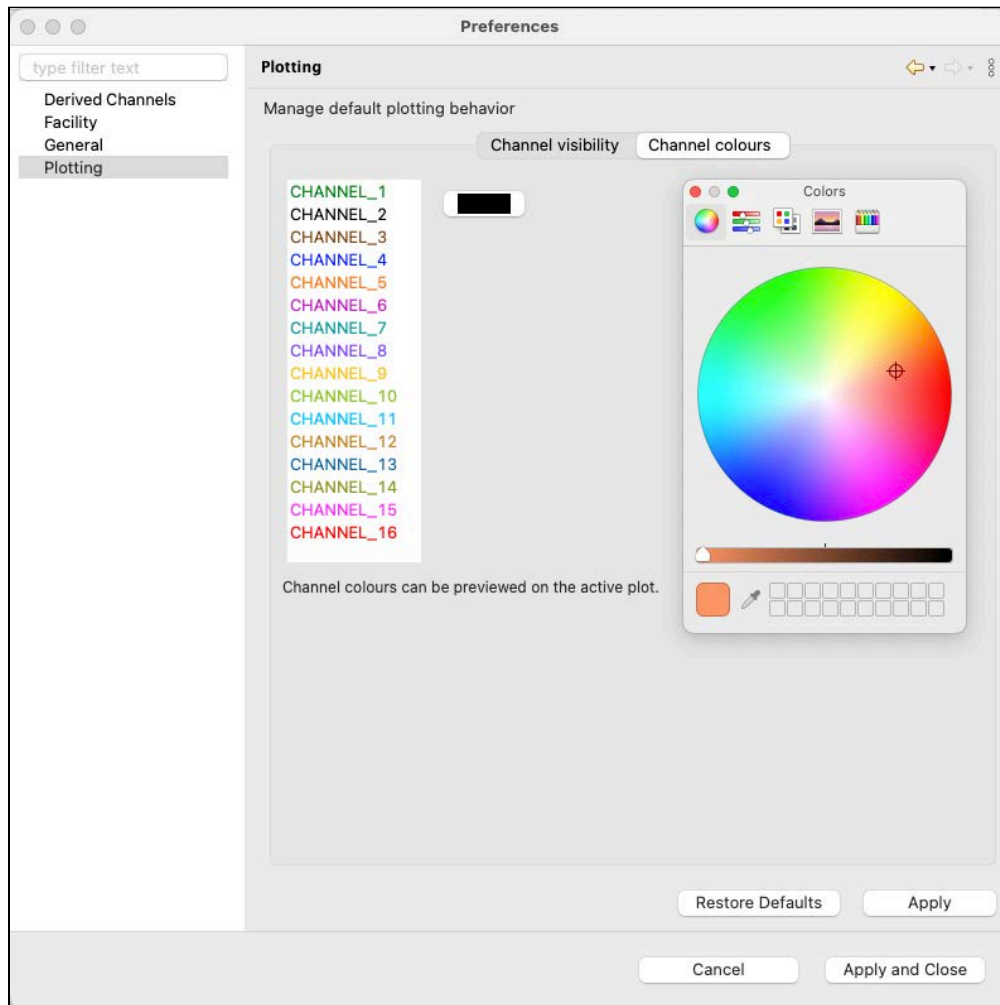

When done, click **Apply** or **Apply and close**. The changes will take effect immediately.

## 13 RSK files

The RSK file is a single file database based on SQLite that allows us to have large files with high-speed access to any part of the dataset. RSK files have different types and versions, which reflect historical changes to the underlying dataset structure. To upgrade the version of an older RSK file, go to [File info](#) tab.

RBR provides open-source [RSKtools](#) toolboxes for both Matlab (RSKtools) and Python (pyRSKtools) to read, post-process, visualise, and export RSK files.

RSK files can be exported to Excel, OceanDataView®, or text files.

RSK files contain raw measurement data, firmware and software versions, dates and times, sampling settings, power settings, measured and derived parameters, errors and events, other diagnostic information.

- Datasets in the **Desktop** storage format allow changes to calibration coefficients. GPS mapping for full RSK files relies on manually added location points. This file format is available for RBR standard and compact instruments.
- Datasets in the **Mobile** storage format support charting and GPS tracking. They do not allow changes to calibration coefficients. This file format is only available for RBR standard instruments.
- For datasets obtained via streaming or fetching, the RSK format is **Realtime**. Their names contain the "realtime" label. This file format is available for RBR standard instruments and RBR*coda*<sup>3</sup> when in streaming mode, and for all instruments when fetching.

To identify the type of the RSK file, go to the [File info](#) tab. Additionally, you can identify a mobile RSK file by the absence of the **Calibration** option in the [Analysis](#) tab.

### File naming convention for datasets obtained during deployments

By default, RSK file names are composed of the following information:

- The instrument serial number: six digits
- The date of the download (YYYY-MM-DD): eight digits
- The time of the download (HH-MM in the 24-hour format): four digits

For example, the file named 209681\_20220531\_1306.rsk contains the dataset for an instrument with a serial number of 209681; the data was downloaded on May 31, 2022 at 13:06 (01:06pm), local time.

The RSK files obtained during a deployment are saved on your instrument. [Download](#) them to your computer before starting a new deployment. Go to **Preferences > General** to change your default location for RSK downloads.

### File naming convention for realtime datasets

By default, realtime dataset names are composed of the following information:

- The instrument serial number: six digits
- The date of the download (YYYY-MM-DD): eight digits
- The time of the download (HH-MM in the 24-hour format): four digits
- The "realtime" label, indicating the data were streamed or fetched from the instrument

For example, the file named 209682\_20220531\_1408\_realtime.rsk contains the dataset for a streaming instrument with a serial number of 209682; the data were saved on May 31, 2022 at 14:08 (02:08pm), local time.

The data streamed or fetched from your instrument are automatically saved to your computer. Go to **Preferences > General** to change your default location for realtime RSK files.

 The file extension is .rsk; it indicates the Ruskin file format and must not be edited. If you change it, your new file extension will become part of the dataset name, and the .rsk extension will be appended.

## 14 Realtime data format

Realtime data can either be streamed or fetched from the instrument.

The output can be in a limited number of formats as described below. Each format is listed alongside an example output for an RBR*concerto*<sup>3</sup> C.T.D:

Output format option	Instrument setting	Example data
Standard resolution	caltext01	2018-12-10 13:06:38.000, 0.0005, 22.9536, 10.1149
Standard resolution (units)	caltext02	2018-12-10 13:06:38.000, 0.0005 mS/cm, 22.9536 C, 10.1149 dbar
Highest resolution (RBR <i>quartz</i> )	caltext03	2018-12-10 13:06:38.000, 0.000525642944, 22.939636, 10.1149120
Engineering	caltext04	2018-12-10 13:06:38.000, 525.642944e-006, 22.9396360e+000, 10.1149120e+000
Standard resolution (checksum)	caltext07	RBR 209681, 2018-12-10 13:06:38.000, 0.0005, 22.9536, 10.1149, 0x59CB

The output format can be changed in Ruskin from the instrument's **Configuration** tab. There is a drop down menu item called **format** in the **Options** section.

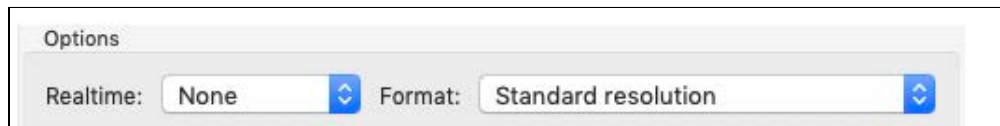

- **Standard resolution**  
All values are shown to four decimal places, with no units displayed.
- **Standard resolution (units)**  
All values are shown to four decimal places, with units displayed (after the number, separated by a space).
- **Highest resolution (RBR*quartz*)**  
All values are shown with enough significant digits ensuring no loss of resolution.
- **Engineering**  
All values are shown in engineering notation (same as scientific notation, but the exponent must be a multiple of three), with enough significant digits ensuring no loss of resolution.
- **Standard resolution (checksum)**  
All values are shown to four decimal places, with no units displayed. The output has the leading characters "RBR" and the serial number of the instrument. After the last data point, there is another field separator (command and space), followed by a checksum: two-byte CRC value which can be used to validate that the transmission was successful.

The values following the timestamp are all the enabled channels.

## 15 Datasets

Datasets are [RSK files](#) generated by Ruskin and have an `.rsk` extension. After [downloading](#) your datasets, you can view and analyse your data using the options below.

Go to the **File** dropdown menu to open or close a dataset, export your data, and see the list of available datasets.

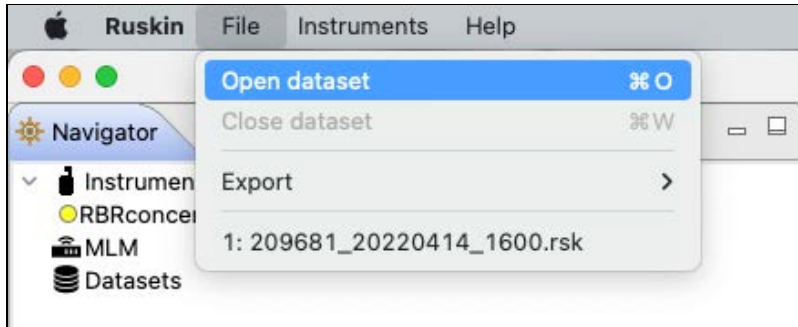

The **Datasets** context menu in the **Navigator** windows duplicates some of these options for convenience.

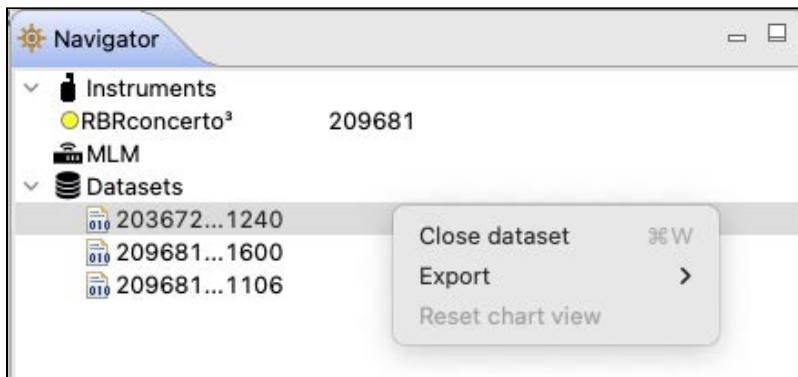

Explore the contents of your datasets in the **Properties** window.

When a dataset on the list is selected, the **Properties** window displays four tabs with information related to this dataset.

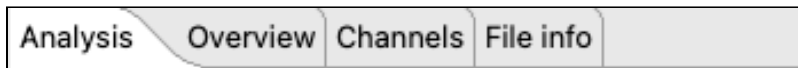

Use these tabs to analyse your data, check the calibration certificates, and verify your parameters.

## 15.1 Open dataset

Open any stored dataset from the **File** menu in the top toolbar or from the **Datasets** menu in the **Navigator** view.

### Steps

1. Click **File > Open dataset**.

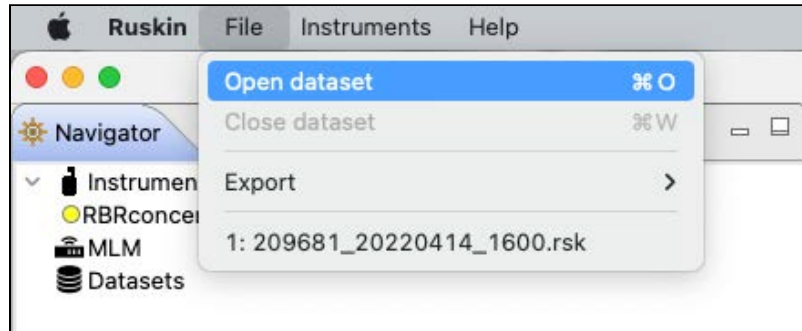

Alternatively, right-click **Datasets** in the **Navigator** view and select **Open dataset**.

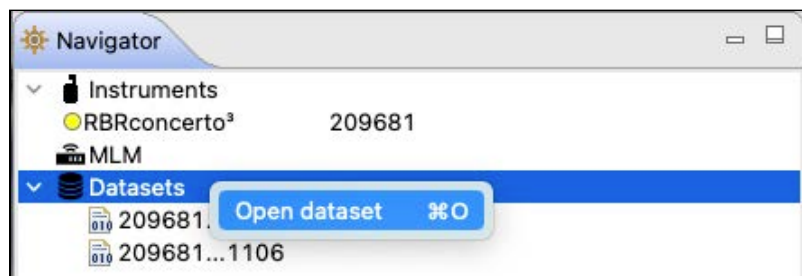

2. A browsing window will appear. Double-click the .rsk file you want to view, or select the file and click **Open**.

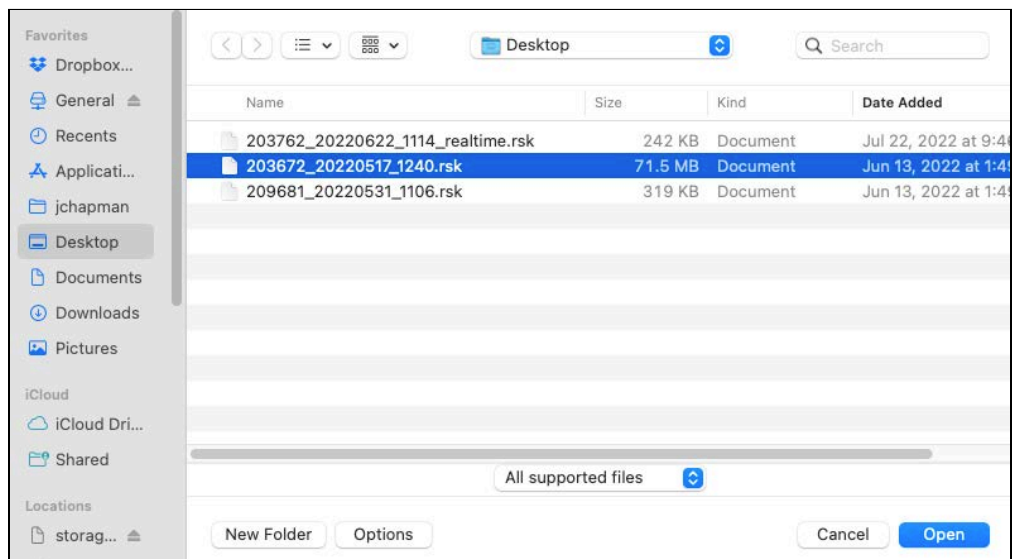



- The name of the dataset appears and is highlighted automatically in the **Navigator** view. The **Properties** view changes to the dataset, with four tabs: **Analysis**, **Overview**, **Channels**, and **File info**.

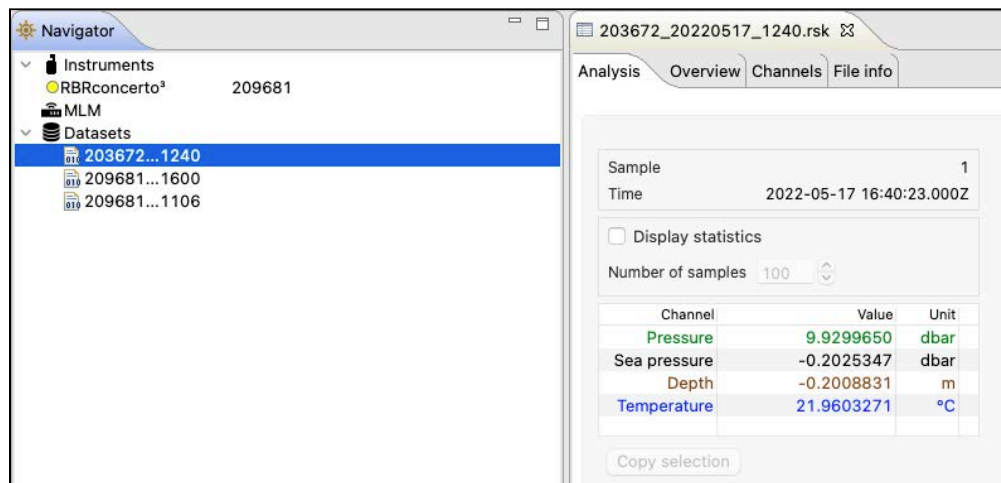

- The data in the file will automatically appear in the **Plot** view.

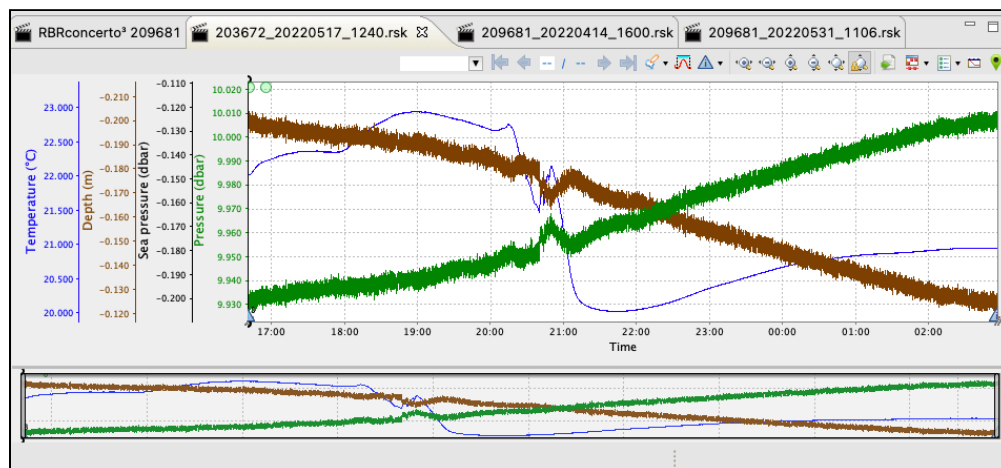

- ✓ To close a dataset, go to **File > Close dataset**. Alternatively, right-click the dataset name in the **Navigator** view and select **Close dataset**. Alternatively, simply close its **Plot** tab by clicking the **X**. The dataset will disappear from the list.

## 15.2 Export

Use the **Export** option to share your data with others or analyse your data using other software. Datasets can be read directly in Matlab with our toolkit [RSKtools](#), or exported to Excel, OceanDataView®, or text files.

### Steps

1. **File** menu > **Export**, then hover to open a set of submenus.

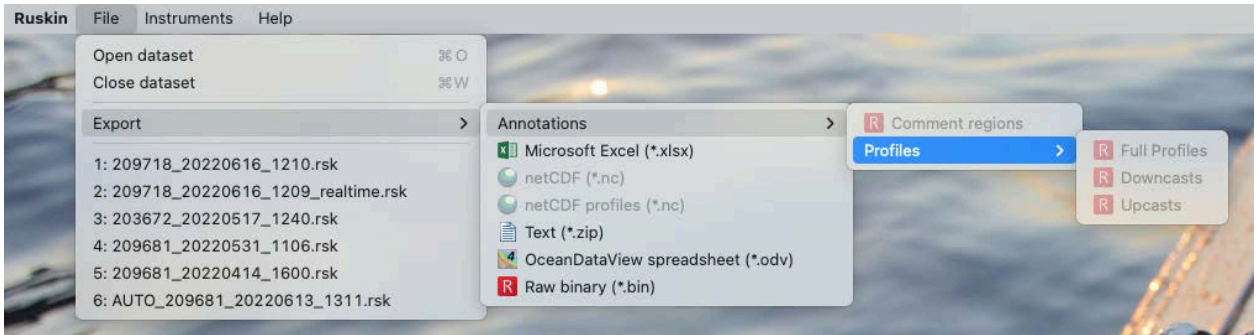

or right-click the dataset in the **Navigator** window, then hover to open a set of submenus.

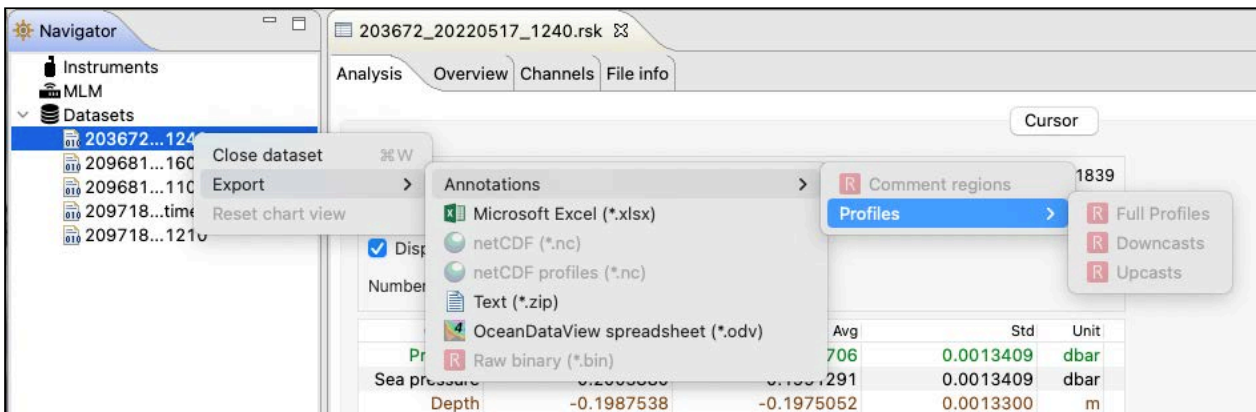

2. Select the appropriate export format (**Microsoft Excel**, **netCDF/netCDF profiles**, **Text**, **OceanDataView spreadsheet**, or **Raw binary**).

 For mobile or realtime RSK files, the **Raw binary** export format is not available.

3. If exporting annotations, select the category: **Full profiles**, **Downcasts**, or **Upcasts**.
4. Specify a location and a name for the data file.
5. Click **Save**.

## 15.3 Analysis

Select a dataset in the **Navigator** view. The **Properties** view will change to dataset properties, with four tabs: **Analysis**, **Overview**, **Channels**, and **File Info**.

For datasets in the **Mobile** storage format, the **Analysis** tab will only have the **Cursor** option.

Channel	Value	Unit
Conductivity	-0.0008081	mS/cm
Temperature	23.6380513	°C
Pressure	9.9474698	dbar
Sea pressure	-0.1850302	dbar
Depth	-0.1835213	m
Salinity	0.0117910	PSU
Speed of sound	1493.0025973	m/s
Specific conductivity	-0.8296216	μS/cm
Density anomaly	-	kg/m <sup>3</sup>

For datasets in the **Desktop** storage format, it will also include **Calibration**.

Channel	Value	Unit
Conductivity	-0.0008081	mS/cm
Temperature	23.6380513	°C
Pressure	9.9474698	dbar
Sea pressure	-0.1850302	dbar
Depth	-0.1835213	m
Salinity	0.0117910	PSU
Speed of sound	1493.0025973	m/s
Specific conductivity	-0.8296216	μS/cm
Density anomaly	-	kg/m <sup>3</sup>

The **Cursor** view contains statistical information about deployment, as well as information about the dataset channels and their values.

The colour-coding of the channel table matches that of the traces in the **Plot** window. To change the colour settings for your chart, go to **Preferences > Plotting > Channel colours**.

Move the black cursor ("double lollipop") in the **Plot** window to display parameter values for each sample selected.

Every time you move the black cursor, going from sample to sample, the table above the plot will display the information for this particular sample.

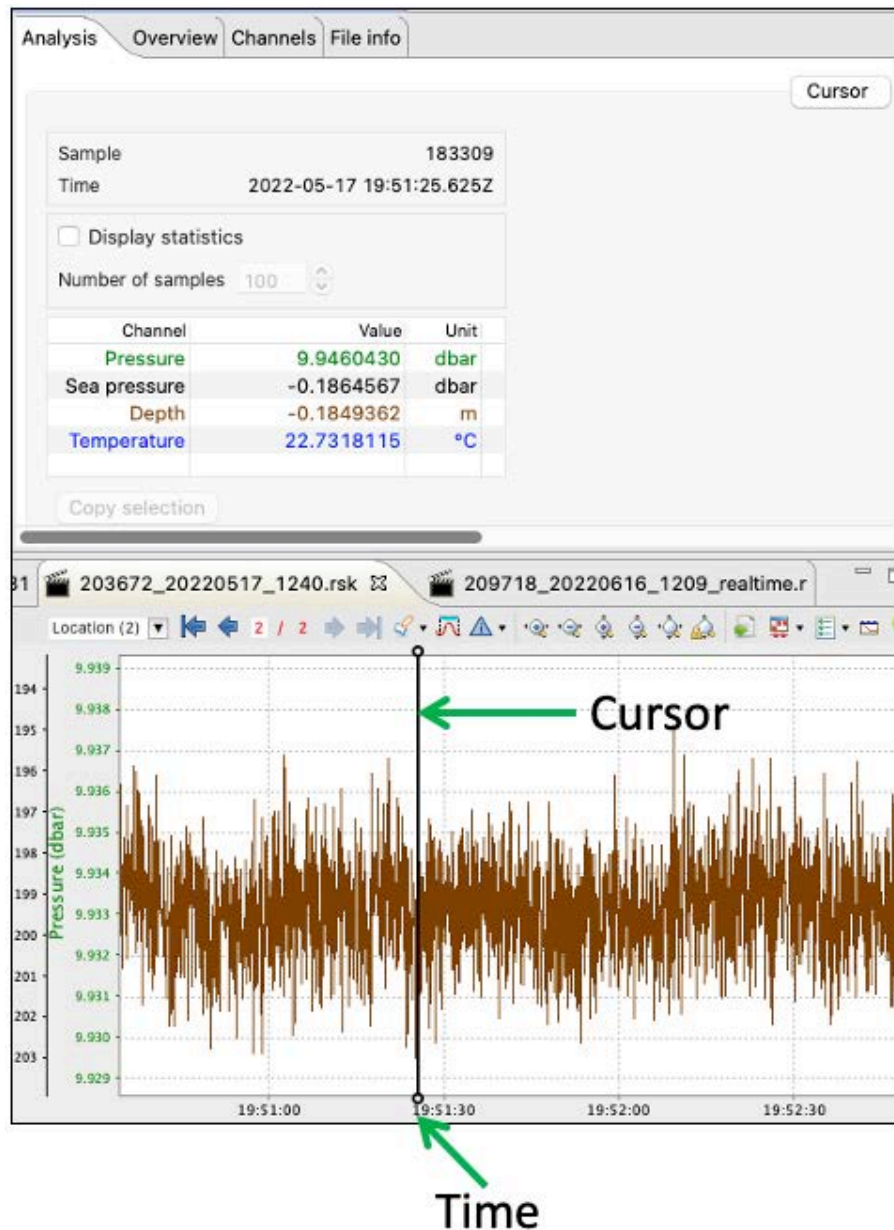

Select **Display statistics** checkbox to determine the average value and standard deviation over a range of samples. Change the number of samples to average using the up and down arrows.

The table will display the averaging data. The averaging interval will be highlighted in the plot.

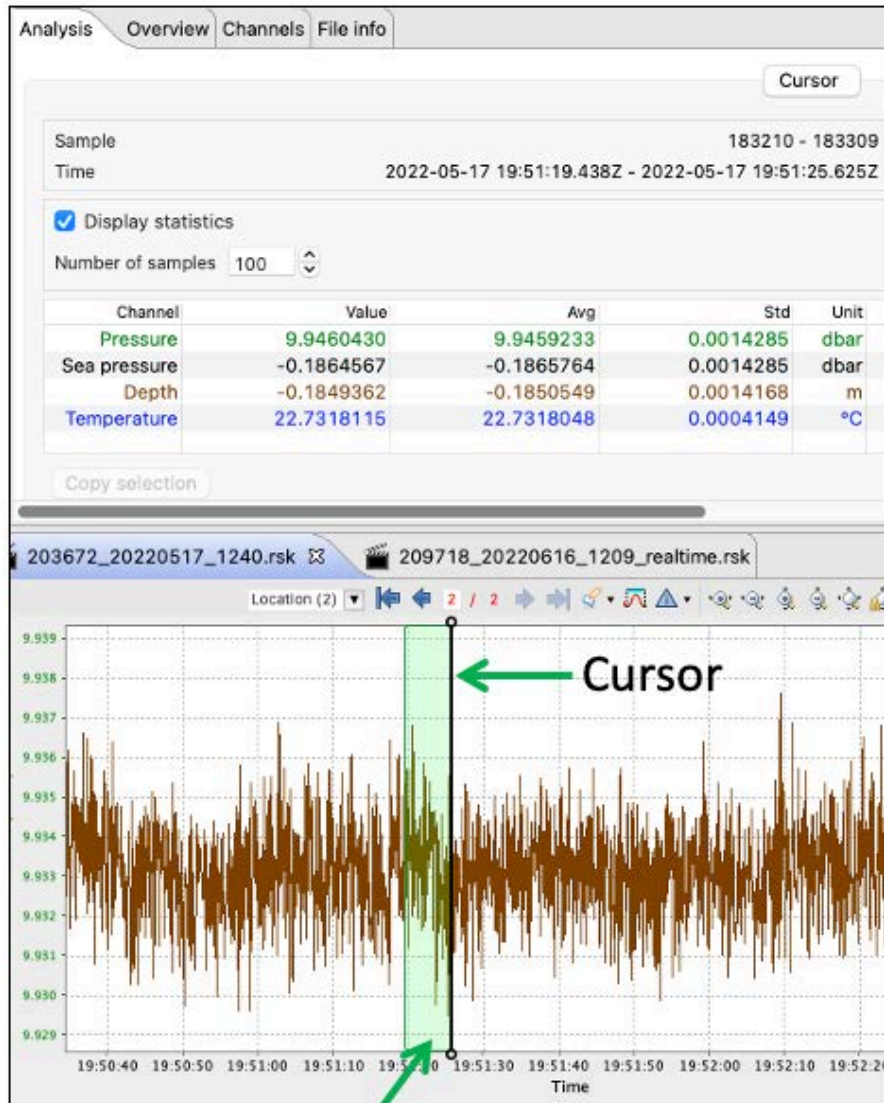

Averaging interval

When the **Calibration** view is available, you can recalculate your coefficients for some channels. See [User calibration](#).

## 15.4 Overview

Use the **Overview** tab to view general information for each dataset, such as instrument details and deployment events.

Analysis Overview Channels File info

File location  
/Users/jchapman/Downloads/209681\_20220531\_1106.rsk

Logger  
Model: RBRconcerto<sup>3</sup>  
Serial: 209681  
Firmware: 1.141

Deployment  
Time offset: UTC-4:00  
Time drift: -1867ms  
Deployment start time: 2022-05-17 15:39:00  
First sample time: 2022-05-17 15:39:27  
Last sample time: 2022-05-17 15:39:29  
First event time: 2022-05-17 15:39:27  
Last event time: 2022-05-17 15:39:31  
Samples: 6

Continuous  
Period: 2 Hz

Markers  
Errors: 0  
Warnings: 1  
Information: 2  
Diagnostics: 0

Gate  
Gate: none

Comment  
  
Save comment

To make a note about this dataset, enter your comment in the field provided and click **Save comment**.

## 15.5 Channels

For datasets in [Desktop](#) storage format, the **Channels** tab will have three options: **Information**, **Calibration**, and **Parameters**.

Analysis Overview Channels File info

Information Calibration Parameters

Measured channels

#	Parameter	Sensor	Range
1	Conductivity (mS/cm)	Marine CT	n/a
2	Temperature (°C)	Marine CT	n/a
3	Pressure (dbar)	RBR	n/a

Derived channels

#	Parameter	Notes
4	Sea pressure (dbar)	Removes atmospheric pressure
5	Depth (m)	Simplified, using density parameter
6	Salinity (PSU)	PSS-78
7	Speed of sound (m/s)	UNESCO algorithm
8	Specific conductivity (μS/cm)	
11	Density anomaly (kg/m <sup>3</sup> )	

For datasets in [Mobile](#) storage format, the **Channels** tab will have only two options: **Information** and **Parameters**.

The screenshot shows the 'Channels' tab with the 'Information' sub-tab selected. It contains two tables:

Measured channels			
#	Parameter	Sensor	Range
1	Pressure (dbar)	RBR	n/a
4	Temperature (°C)	Pressure correction	n/a

Derived channels		
#	Parameter	Notes
2	Sea pressure (dbar)	Removes atmospheric pressure
3	Depth (m)	Simplified, using density parameter

### Information

The **Information** page displays two tables: **Measured channels** and **Derived channels**.

**Measured channels** include measured parameters with their units of measurement, the sensor manufacturer, and the range setting (if applicable).

Measured channels			
#	Parameter	Sensor	Range
1	Conductivity (mS/cm)	Marine CT	n/a
2	Temperature (°C)	Marine CT	n/a
3	Pressure (dbar)	RBR	n/a

**⚠** The RBR*concerto*<sup>3</sup> Tx will have multiple (12 or 24) temperature sensors listed in the **Measured channels** table, and their numbering will start from the end of the string. For example, for a 12-node thermistor string, Channel 12 will be the node closest to the connector.

**Derived channels** include all available derived parameters with their units of measurement and the methodology used to calculate them.

#	Parameter	Notes
4	Sea pressure (dbar)	Removes atmospheric pressure
5	Depth (m)	Simplified, using density parameter
6	Salinity (PSU)	PSS-78
7	Speed of sound (m/s)	UNESCO algorithm
8	Specific conductivity ( $\mu\text{S}/\text{cm}$ )	
11	Density anomaly ( $\text{kg}/\text{m}^3$ )	

### Calibration

The **Calibration** page displays the calibration coefficients and correction coefficients (as applicable) for each channel, as well as the date and time of the last calibration. Select a sensor from the **Parameter** dropdown menu to display its calibrations.

 Only datasets in [Desktop](#) storage format have this option.

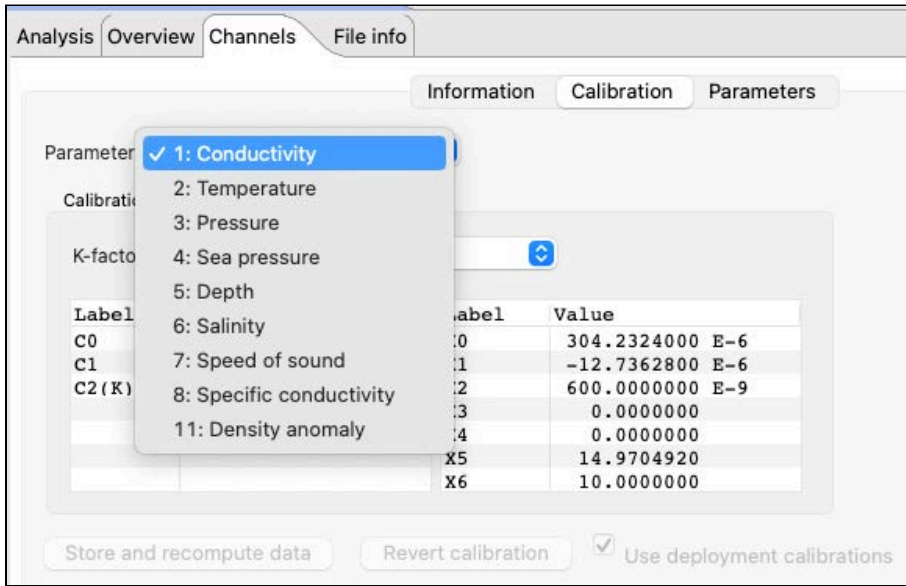

The screenshot shows the 'Calibration' tab in a software interface. A dropdown menu is open, listing parameters: 1: Conductivity (selected), 2: Temperature, 3: Pressure, 4: Sea pressure, 5: Depth, 6: Salinity, 7: Speed of sound, 8: Specific conductivity, and 11: Density anomaly. Below the menu is a table of calibration coefficients:

Label	Value
C0	304.2324000 E-6
C1	-12.7362800 E-6
C2 (K)	600.0000000 E-9
X3	0.0000000
X4	0.0000000
X5	14.9704920
X6	10.0000000

At the bottom of the interface, there are buttons for 'Store and recompute data', 'Revert calibration', and a checked checkbox for 'Use deployment calibrations'.

The main calibration coefficients are displayed as "C" values: C0, C1, C2(K). Dependent coefficients are displayed as "X" values: X0, X1, X2, etc.



You can edit any of the coefficients in your dataset, regardless of the advanced calibration controls settings in **Preferences**.

As soon as you make a change and move to another cell, a new calibration date will be displayed. Also, all three buttons at the bottom of the page will become active.

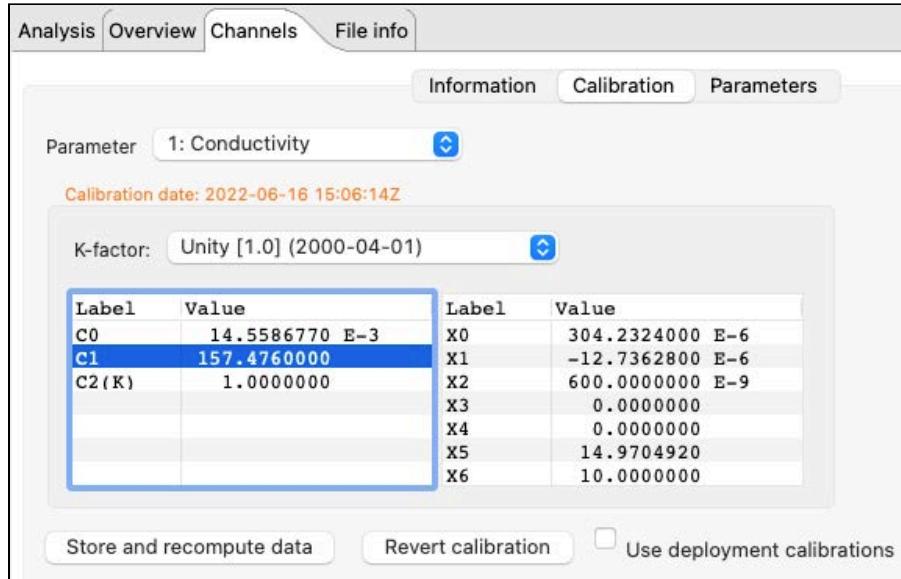

Use **Store and recompute data** to recalculate the dataset. Use **Revert calibration** to recover the previous coefficients and data if you have not already selected **Store and recompute data**.

To revert calibration and recalculation after it was stored, check the **Use deployment calibrations** checkbox. Click **Store and recompute data** to save the reverted coefficients.

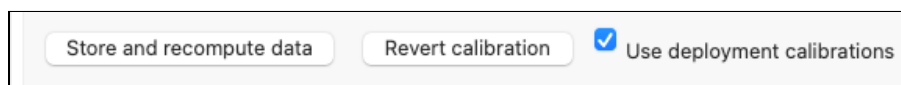

## Parameters

The **Parameters** tab displays parameters necessary to calculate derived channels and the method used for calculation.

You can edit these parameters to change the derived channel calculation. As soon as you make a change, the two buttons at the bottom of the page will become active.

Parameter	Value
Atmospheric pressure (dbar)	9.7700
Density (g/cm <sup>3</sup> )	1.0000
Latitude (degrees)	0.0
Speed of sound type	UNESCO
Specific conductivity coefficient	0.0191
Oxygen concentration units	mg/L
Salinity	35.0
Absolute pressure (dbar)	10.1325
Temperature (°C)	0.0
Average sound speed (m/s)	1550.744

Click **Update and recompute** to recalculate the data and display new values.

Use **Revert settings** to recover the previous coefficients and data if you have not already selected **Update and recompute**.

**⚠** For **Mobile** RSK files, you cannot recalculate the data. Clicking **Update and recompute** will not save the changes.  
For **Realtime** RSK files, the fields are not editable.

## 15.6 File info

The **File info** page displays the dataset name and download location, Ruskin version used when it was obtained, file structure, and size.

The **Structure** label reflects the **RSK file format**, which can be **Desktop**, **Mobile**, or **Realtime**.

Ruskin checks the dataset for compatibility with the newest version of Ruskin software. If the file requires updating, a warning message and an **Update** button will be displayed.

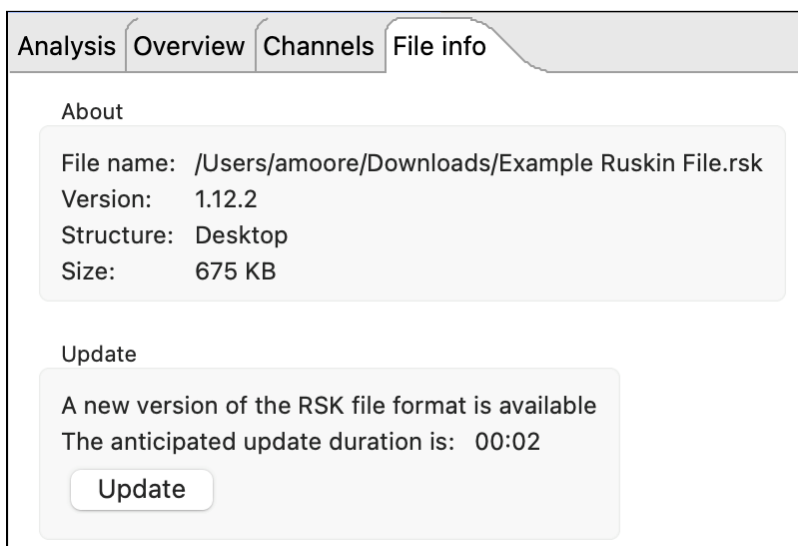

Click **Update**. It may take several minutes for it to complete. RBR strongly recommends that all datasets are updated and meet compatibility requirements.

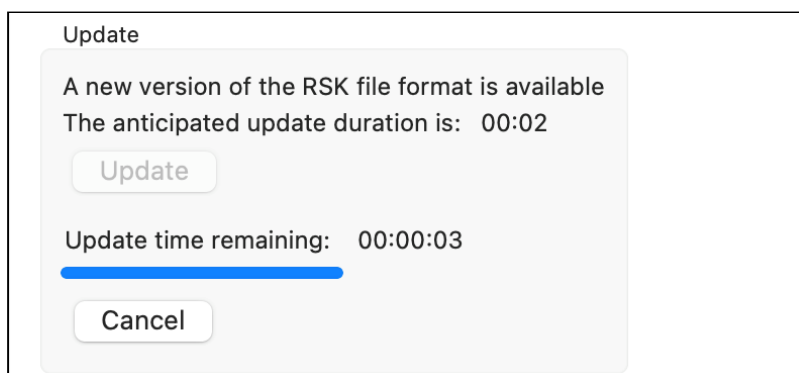

 Failing to update your dataset may result in odd graphical displays and incorrect reporting of the sample values.

## 16 Plot window

Use the **Plot** window to view graphical displays of your datasets or live data. When viewing live data, the instrument must be attached.

Each channel appears as a different colour in the plot. These colours are specified under **Preferences > Plotting** and can be changed only there.

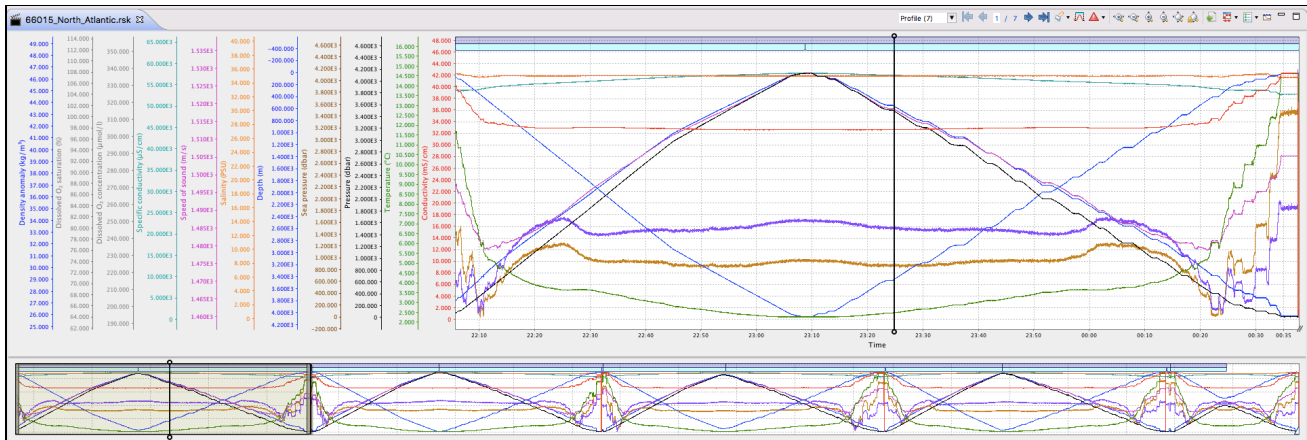

Move the black "double lollipop" cursor from one sample to the next to display parameter values for each sample selected. Drag it with your mouse, or use the arrow keys on your keyboard as follows:

- To move by one data sample, press **right** or **left arrow**
- To move by a hundred of samples, press **Shift + right arrow** or **Shift + left arrow**
- To move by ten thousand of samples, press **Alt + right arrow** or **Alt + left arrow**
- To move by millions of samples, press **Shift + Alt + right arrow** or **Shift + Alt + left arrow**

For the datasets, these values will appear in the **Properties** window above (see [Analysis](#)). For live data, they will be on the side of the plot.

The graphical display for each dataset or instrument will be in its own tab. The dataset file name or the instrument model and serial number will appear at the top of the tab. Simulated instruments will have "sim" in front of their name.



A toolbar at the top right of the **Plot** window contains various buttons to help you customise, explore, and export the graphical display. The buttons selection changes depending on what is displayed in the tab. Hover over a button to display its name and function.

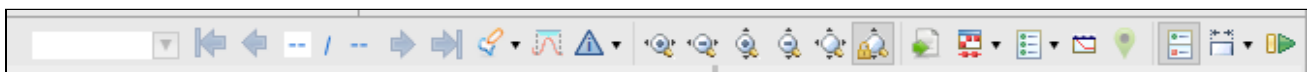

A downsampled representation of the dataset appears in the thumbnail view, along with an indicator of the current plotted time range.

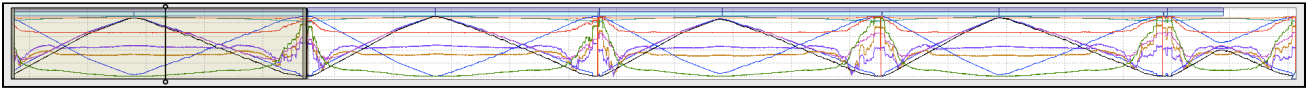

Position the indicator by clicking on the thumbnail view and dragging the indicator. Resize the indicator by dragging the edges left and right. It will zoom the main plot along the time domain to match the new indicator size. See [Zoom controls](#) for more scaling options.

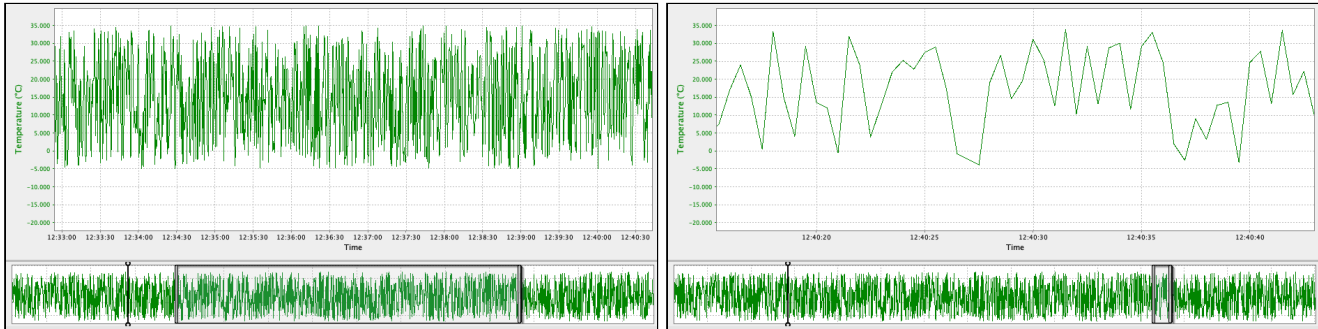

 The thumbnail view always shows the plot-by-time data, even if the plot is switched to the plot-by-depth mode.

When you close and re-open a dataset, it will retain your latest settings (channel visibility, zoom, plot style (plot-by-time or plot-by-depth), annotation selection, and display style (lines or markers)).

Double-click anywhere on the main plot to return to the full-chart view.

 Go to [Appearance controls](#) to change your selection of lines and markers.

## 17 Dataset plot toolbar

Use the plot toolbar to adjust the display of an open dataset.

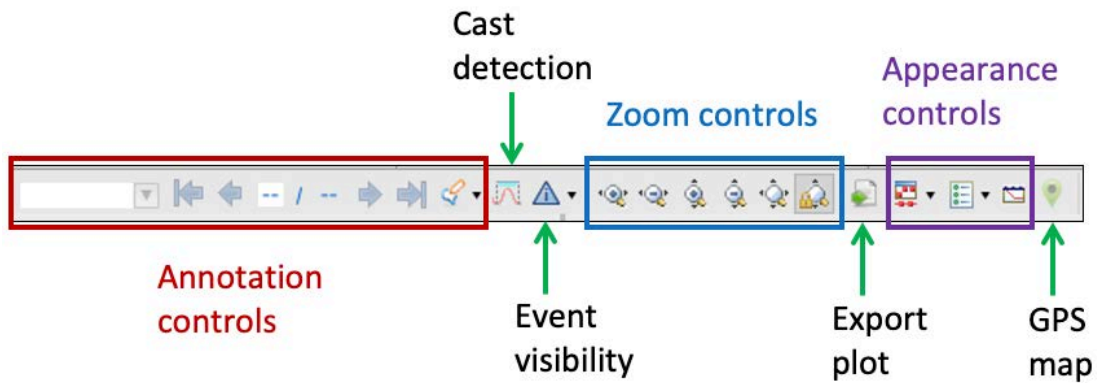

### 17.1 Annotation controls

Annotations are information messages added either by users or by the instrument.

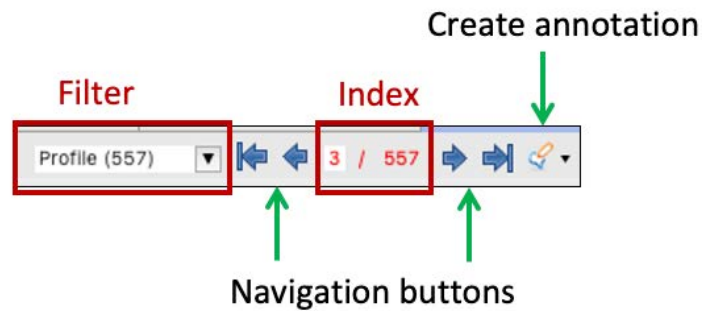

#### 17.1.1 Select annotation type

Annotation types are divided in two categories: profiling (**Profile**, **Downcast**, or **Upcast**) or non-profiling (**Comment**, **Exclusion**, **Location**, or **Calibration**). Use annotation controls to manage this information and to navigate the plot.

Type	Function
<b>Profile, Downcast, Upcast</b>	Identify profiling
<b>Comment</b>	Add a note to your data
<b>Exclusion</b>	Remove a non-representative interval from analysis
<b>Location</b>	Add in latitude/longitude coordinates for RSK files to track locations of data logging
<b>Calibration</b>	Calibrate the ODO sensor (available only for RBR standard instruments using the RBR <i>coda</i> <sup>3</sup> T.ODO as an integrated sensor)

Open the **Filter** dropdown menu to select the annotation type to display. The number of annotations for each type will be indicated.

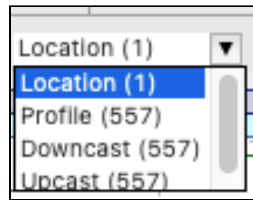

Select an annotation type. The plot will centre on the first item in the selected category. For example, when you select **Profile**, the plot will move to the first profile.

If you switch the filter to another annotation type within the same category (for example, **Profile** to **Upcast**), the plot will not change. If you switch to a type from another category (for example, from **Profile** to **Comment**), the plot will move to the first annotation in the new category (for example, to the first comment).

### 17.1.2 Navigate between annotations



Use the **Navigation** buttons to navigate between items within the selected category.

**⚠** The navigation buttons will be activated if there is more than one item in the selected annotation type. Otherwise, the plot will centre on the only item available.

#### Navigation controls

- Move from one annotation to another by clicking the **left** and **right** arrows.
- Jump all the way to the beginning or end of the list by using the **end-left** and **end-right** arrows.
- Alternatively, manually enter the number in the **Index** field to go to that particular annotation.
- Double-click an annotation to centre and zoom in the plot at that particular area.

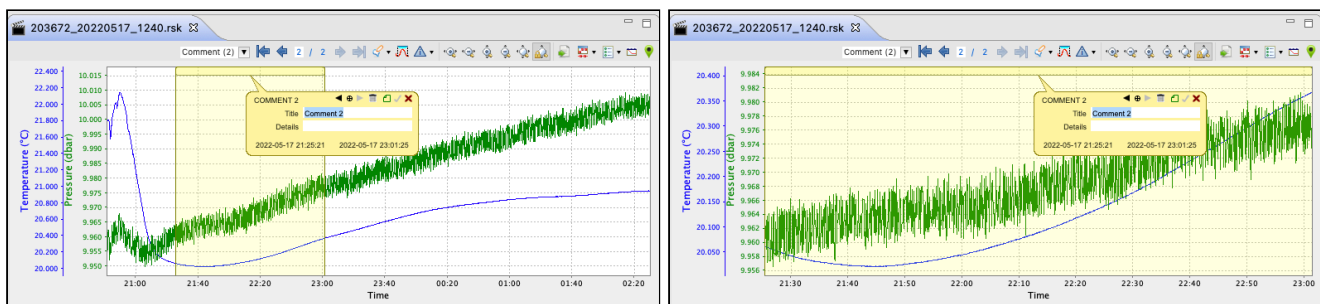

**✓** Double-click anywhere on the main plot to return to the full-chart view.

### 17.1.3 Create new annotation

Click the **Create annotation** button  and follow the steps below.

#### Steps



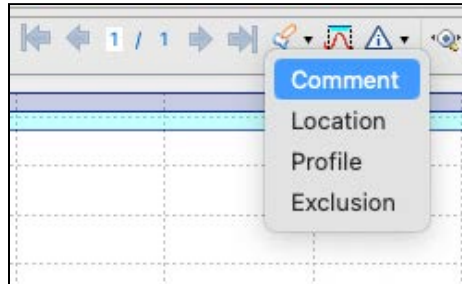

Select the type of annotation to create, for example, **Comment**.

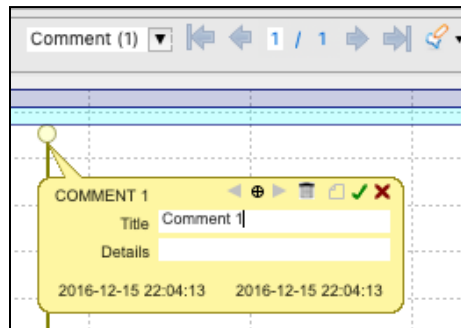

The cursor in the **Plot** window will become a two-way arrow .

1. Click on the main plot to identify a single point to comment, or click and drag the cursor left or right to select an interval. When you release the click, an editable tooltip will open.





The tooltip controls include **Left** and **Right** arrows , **Delete** , **Export region** , **Save** , and **Close** .

The **Profile** tooltip also features **Up** and **Down** arrows  for adding upcast and downcast profiles.



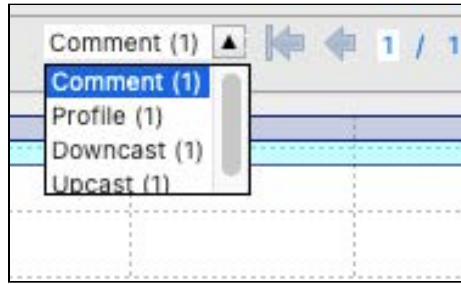

2. Enter the necessary information into the fields and save by pressing **Enter** on your keyboard or by clicking **Save**  on the tooltip. Your new comment will appear in the dropdown list.



Clicking **Close**  or pressing **Esc** on the keyboard will close the tooltip without saving.

 Edit at least one detail in the tooltip before saving. Otherwise, the annotation will be deleted when deselected. Moving or resizing the annotation counts as editing and saving.

3. Click the **arrows**  on the tooltip to move to the next annotation within the same category.
4. Double-click on the annotation bar to zoom in to the range of the annotation.
5. Click and drag on the annotation bar to move the annotation.
6. Click **Delete**  on the tooltip to delete the annotation. A warning message will appear.

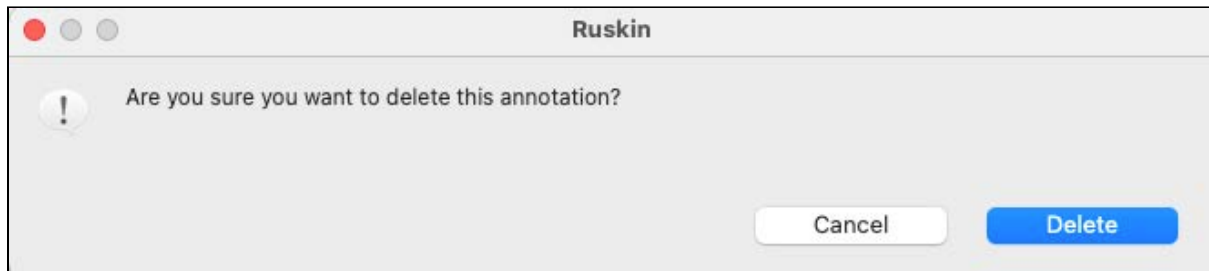

Click **Delete** to proceed. This action cannot be undone.

## 17.1.4 Add profiles

Use the **Annotation** function to manually add profiles to your dataset.

### Steps

1. Click the **Create annotation** button  and select **Profile** from the dropdown menu.

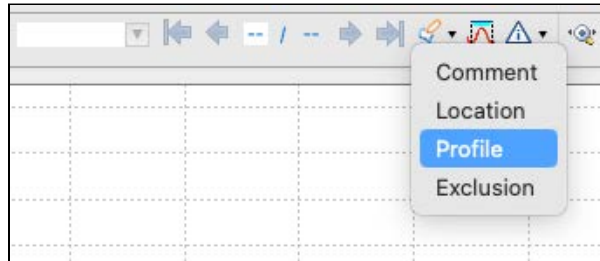

2. Click and drag the cursor to select a region.

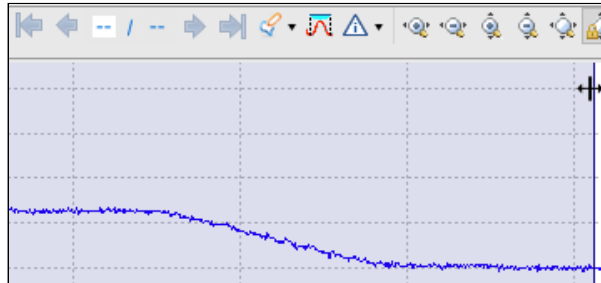

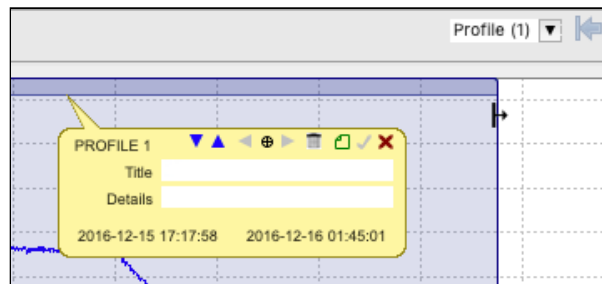

As soon as you let go, an editable tooltip will open and a band of a darker colour will appear above the selection, indicating that a new profile has been added.

3. Place the cursor on the edge of this new profile and move it left or right to adjust the size.

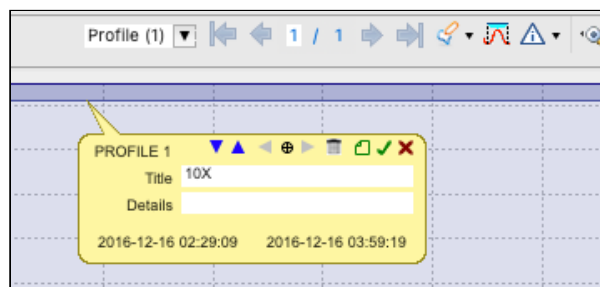

4. Add a name and click **Save**  on the tooltip.



- Use the **Up** and **Down** arrows  on the tooltip to identify upcast and downcast regions. The upcasts and downcasts you added will be displayed in the dropdown menu and highlighted on the plot under the parent profile.

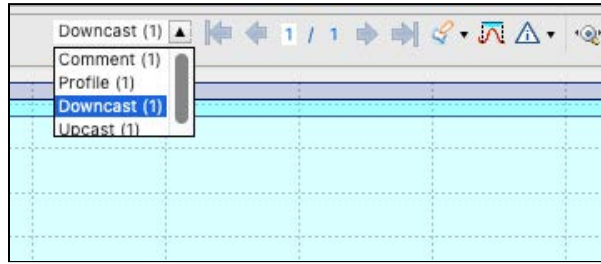

 Only the **Profile** tooltips have the **Up** and **Down** arrows.

- Place the cursor at the edge of the added region and adjust its size.

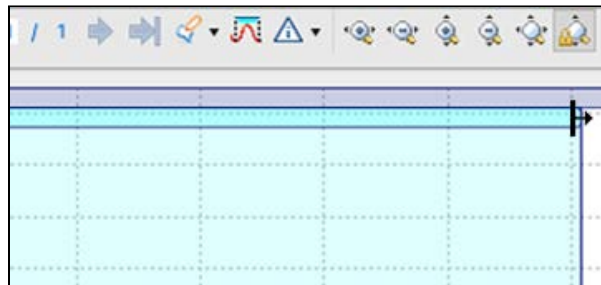

- Click on a profile/upcast/downcast to open its tooltip.

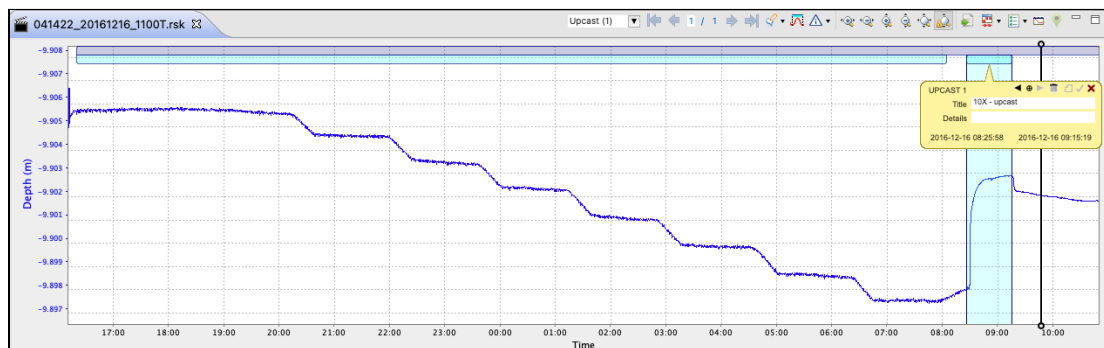

- Name each region and save the settings.

- If desired, export your profile to a separate RSK file. To do that, click **Export region**  on the **Profile** tooltip and [follow the steps](#).

 The **Export region** option is not available on **Upcast** and **Downcast** tooltips. To generate an RSK file for an upcast or downcast section only, use the **Comment** annotation to [clip the dataset before exporting](#).

## 17.1.5 Export region

 The **Export region** option is only available for **Comment** and **Profile** annotations.

Follow the steps below to clip your dataset and export a subset of your data. This function may be useful when you need to exclude certain regions. For example, a dataset may contain several deployments if sampling was not paused/stopped before the new deployment was started.

### Steps

1. Click the **Create annotation** button  and select **Comment** from the dropdown menu.

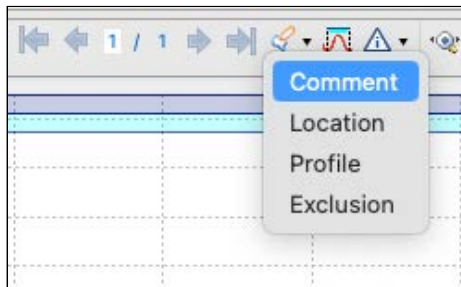

2. Click and drag the cursor to select a subset.

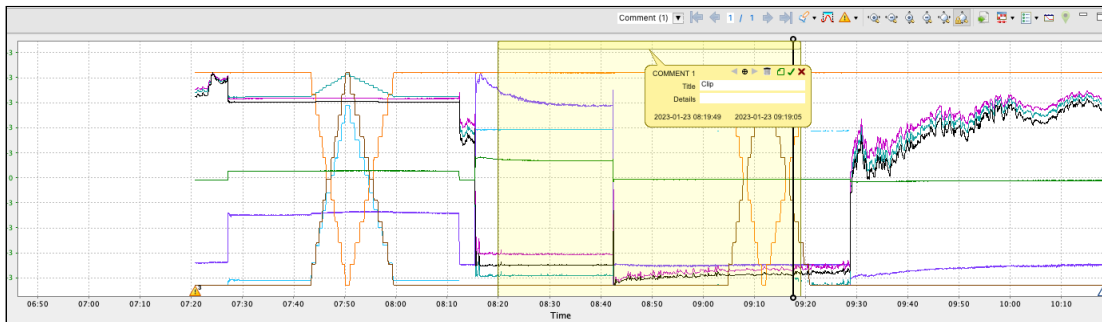

3. Enter a name in the **Title** field on the tooltip and click **Save** .

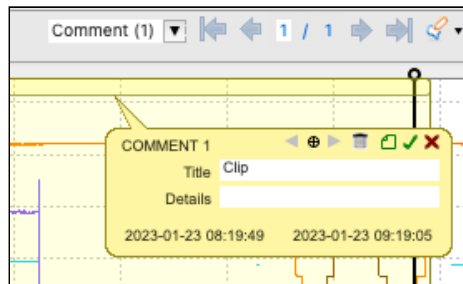

- Select **Export region**  on the tooltip. A dialogue box will open.

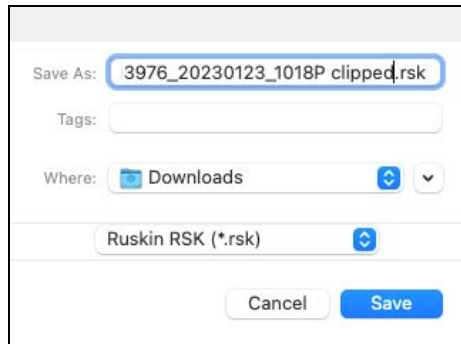

- Adjust the name and location for the new dataset file and click **Save**. An **Export region** message will appear.

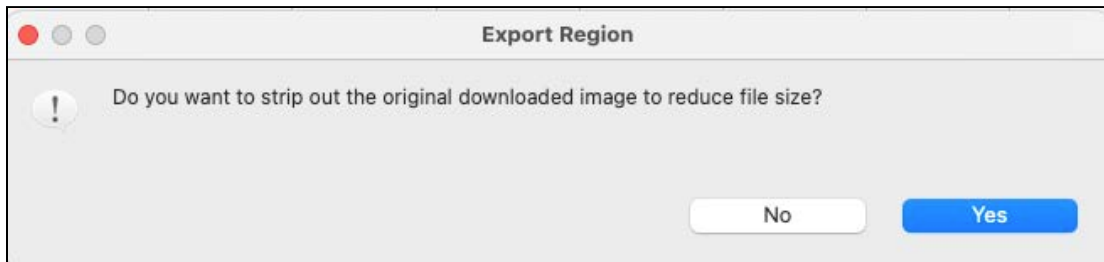

- Select **No** to maintain the full binary values and retain the option of recalibration in the future. The clipped dataset will open in a new tab in the **Plot** window.

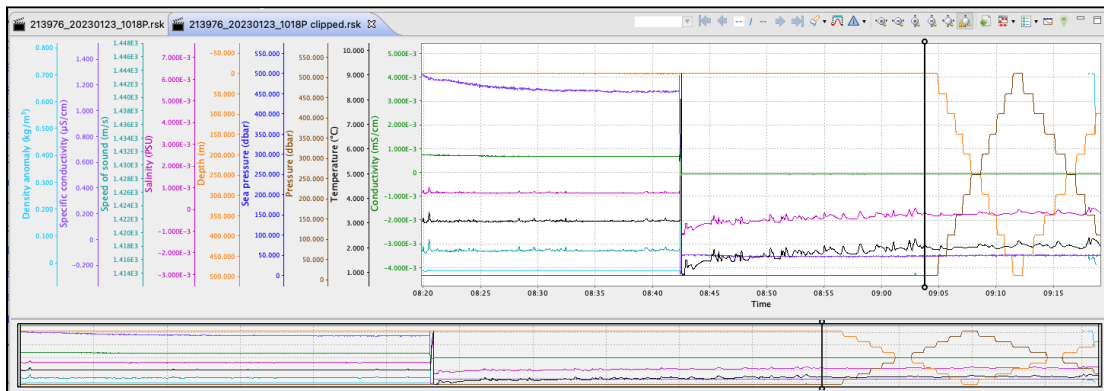

## 17.2 Cast detection

Ruskin automatically enables profile detection on instruments when a deployment is enabled. There are several criteria for enabling this feature.

- The instrument must support the `castdetection` setting
- The instrument must have a pressure sensor
- The deployment must be configured for | fast sampling (2Hz and up)
- The deployment mode must be configured as either continuous or directional

It is possible to recalculate the casts in a dataset using the cast detection feature in the **Plot** view.

Click the **Cast detection** button  to run a cast detection algorithm based on depth and conductivity to automatically generate profiles and casts. A warning message will appear.

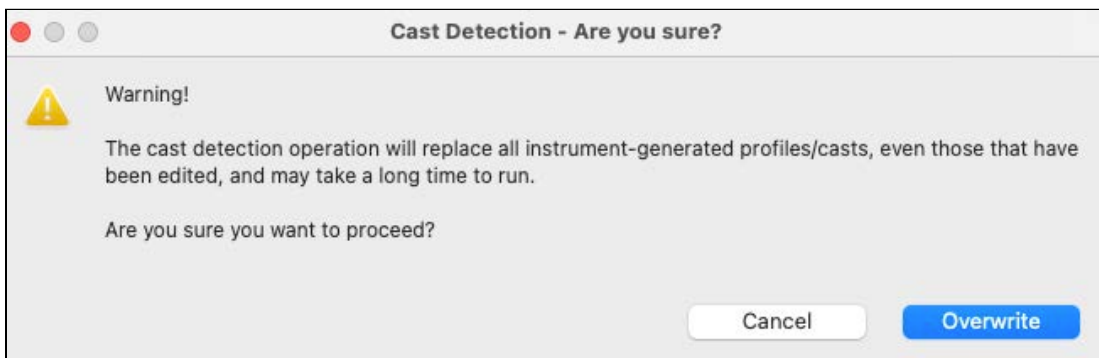

If you proceed, Ruskin will find peaks, collect events, and overwrite profiles recorded by the instrument.

✔ Double-click anywhere on the main plot to return to the full-chart view.

## 17.3 Event visibility

Click the **Event visibility** button  to turn on and off the visibility of the various levels of events: **Error**, **Warning**, **Information**, and **Diagnostic**. Its colour will reflect the highest level of event severity reported.

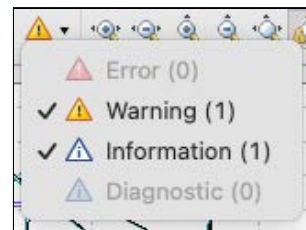
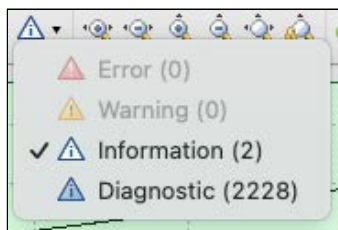
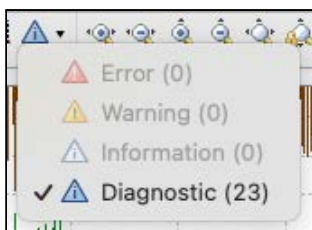

## 17.4 Zoom controls

Default scaling of the plot is based on the minimum and maximum values sampled for each channel. Use zoom controls to adjust it as needed.

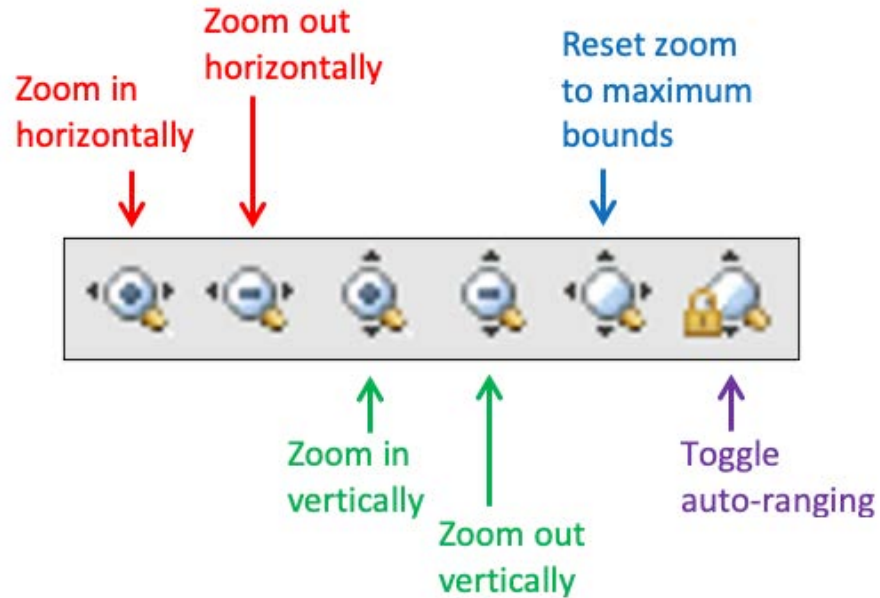



✓ Double-click anywhere on the main plot to return to the full-chart view.

### 17.4.1 Horizontal zoom

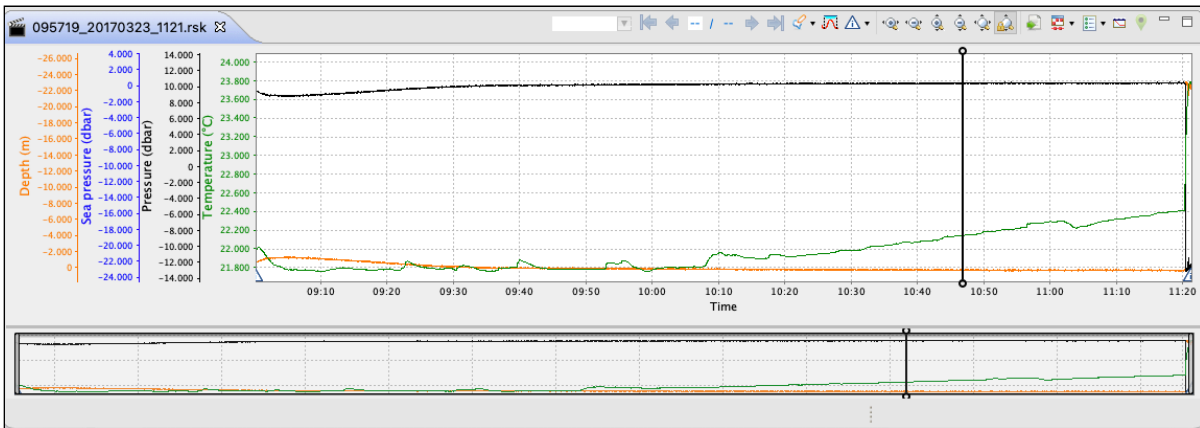
Horizontal scale options may be helpful to increase or decrease the time range displayed. It is convenient when the dataset is long and thus losing resolution when displayed in the **Plot** window in its entirety, like in this example.



There are three ways to apply changes to the horizontal scale. The first two will auto-range your chart, ensuring the entire vertical domain is visible. The third approach will retain the latest vertical scaling of the original interval.

1. Use the **Zoom in horizontally**  and **Zoom out horizontally**  buttons.

OR

2. Click on the thumbnail view and resize the indicator.  
The vertical scale will automatically adjust to fit the new range.

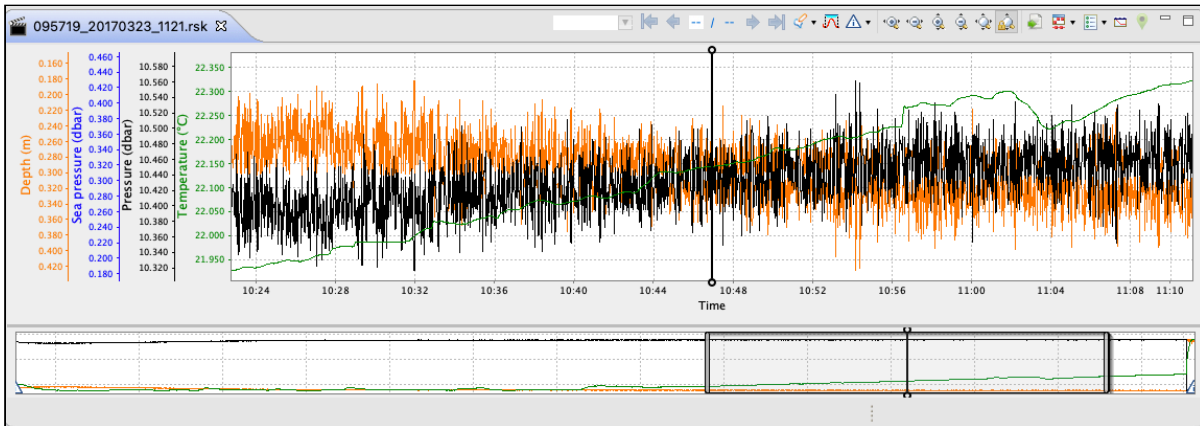

3. Hover your mouse over the X-axis, then hold **Shift + left click**.

The cursor will change to a two-way arrow . Drag it right to zoom in or left to zoom out the time domain, without changing the data resolution.

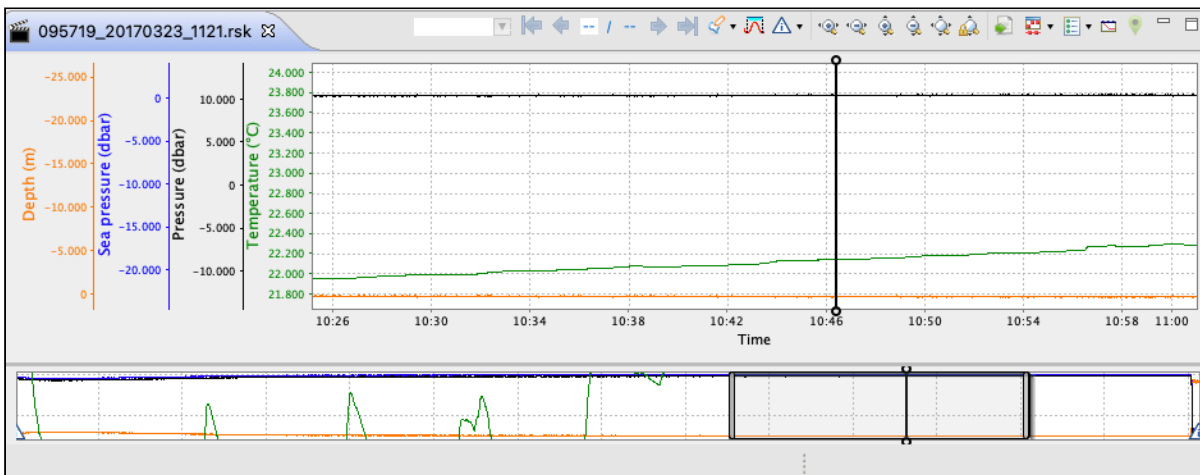

Click **Reset zoom to maximum bounds**  or **double-click** anywhere on the chart to restore the original appearance.



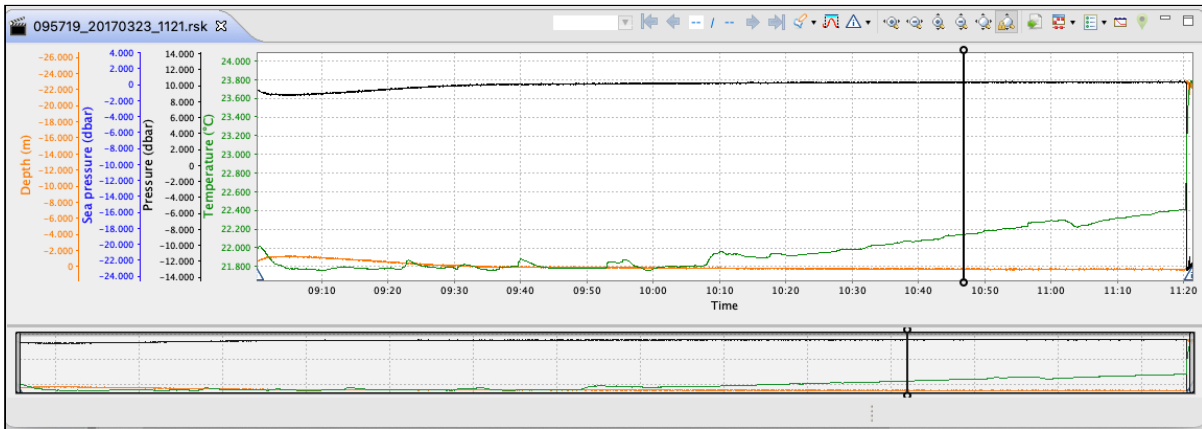

## 17.4.2 Vertical zoom

Vertical scale options may be helpful when there are erroneously high or low values that make the real data appear incorrect, or when there is significant difference in scale between the displayed parameters.



### Entire chart

Depending on the zooming method, you may change the scale only vertically, or both vertically and horizontally.

1. Use the **Zoom in vertically**  and **Zoom out vertically**  buttons to increase or decrease the resolution of the data displayed.  
The resulting display will retain the same horizontal scale.

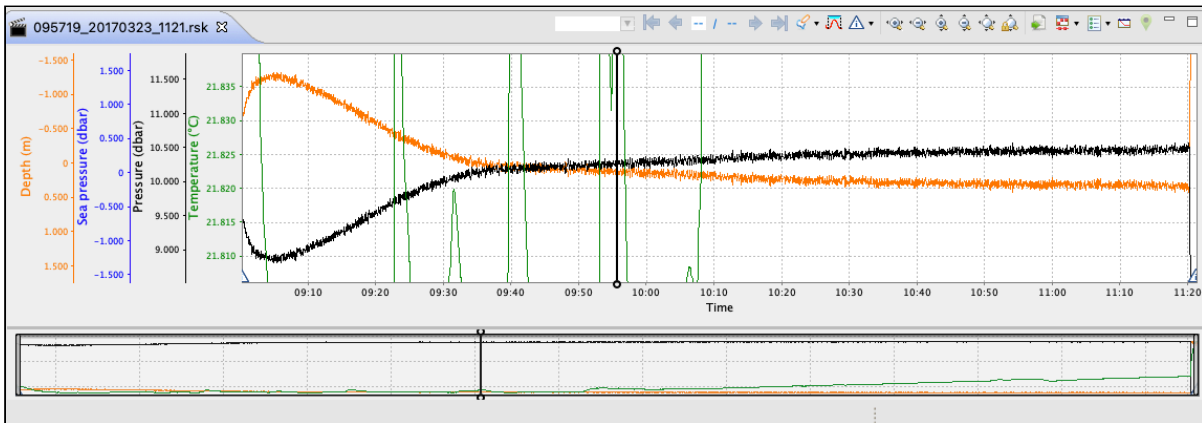

OR

2. Hover the cursor and scroll your mouse wheel up and down to change the scale.  
In this case, the horizontal scale will also change (as seen from the thumbnail indicator). The plot will centre where the mouse cursor initially was.

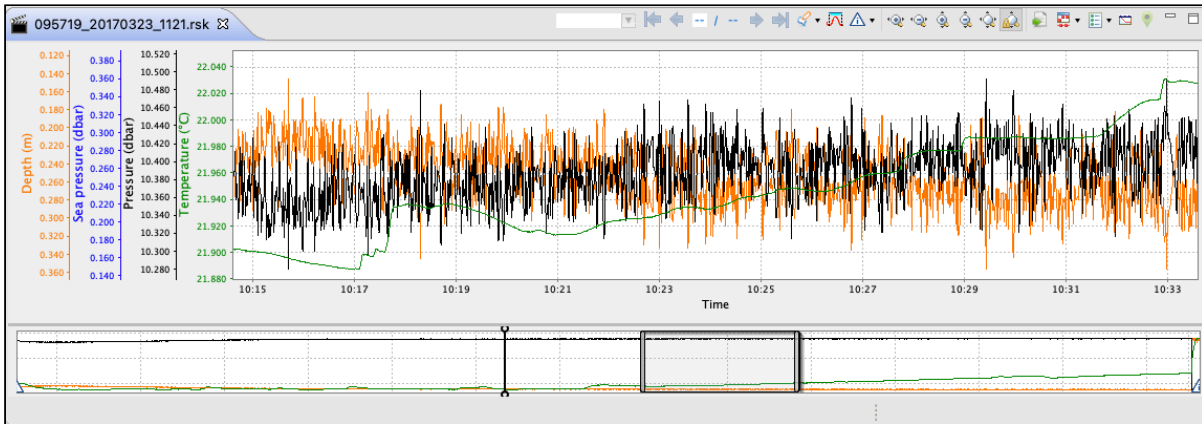

### Individual channel

There are two ways to apply changes to the vertical scale of one channel only, which yield the same results.

1. Hover the cursor over the Y-axis for this channel and scroll your mouse wheel up and down.

OR

2. **Shift + click** the Y-axis for this channel and move your mouse up and down.

This particular channel will zoom in and out (in the example below, temperature). Double-click on the same vertical axis to reset this parameter.

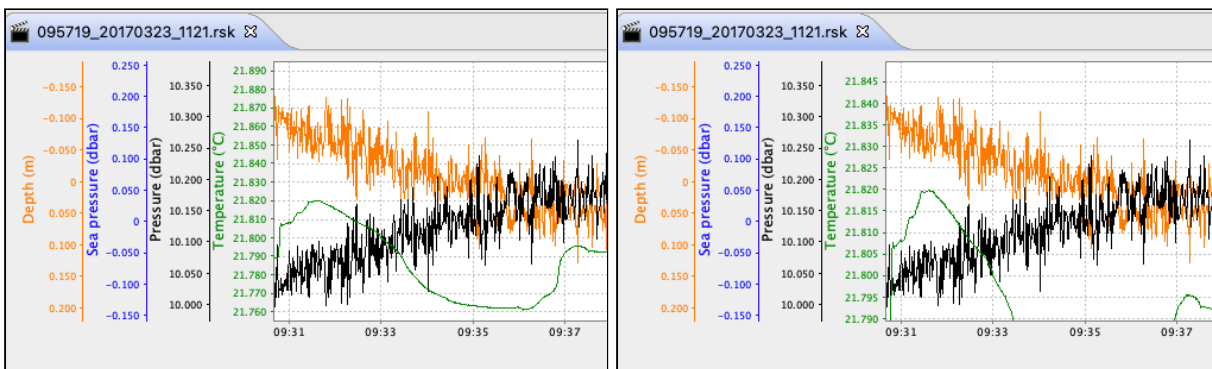

Click **Reset zoom to maximum bounds**  or **double-click** anywhere on the chart to restore the original appearance.

## 17.4.3 Navigation options

After you change the scale, some parts of your chart may end up outside the **Plot** window. There are several options available to navigate it.

1. To pan the entire chart horizontally, hold **Ctrl + left click** and move your mouse left and right.

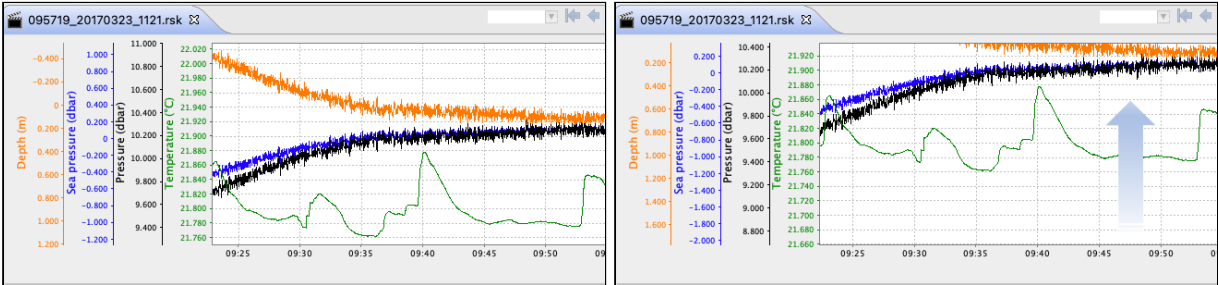

This action is only possible after already applying some horizontal zoom to the chart.

2. To pan the entire chart vertically, hold **Ctrl + left click** and move your mouse up and down.

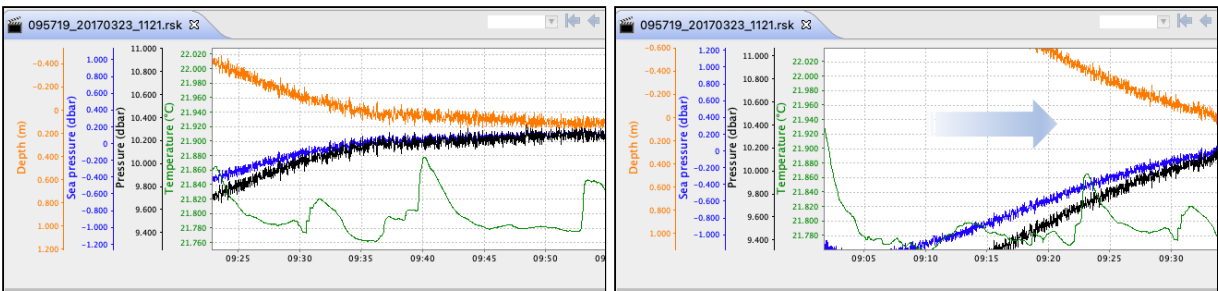

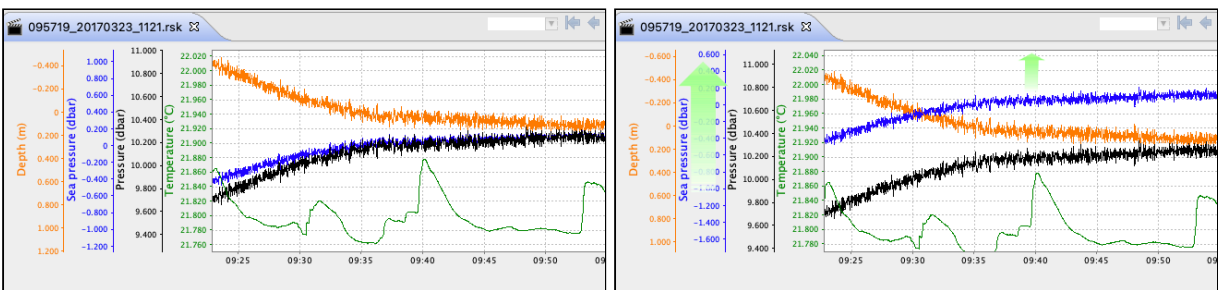

3. To pan one of the channels vertically, click a value on the vertical axis for that parameter (in the example below, sea pressure) and move your mouse up and down.

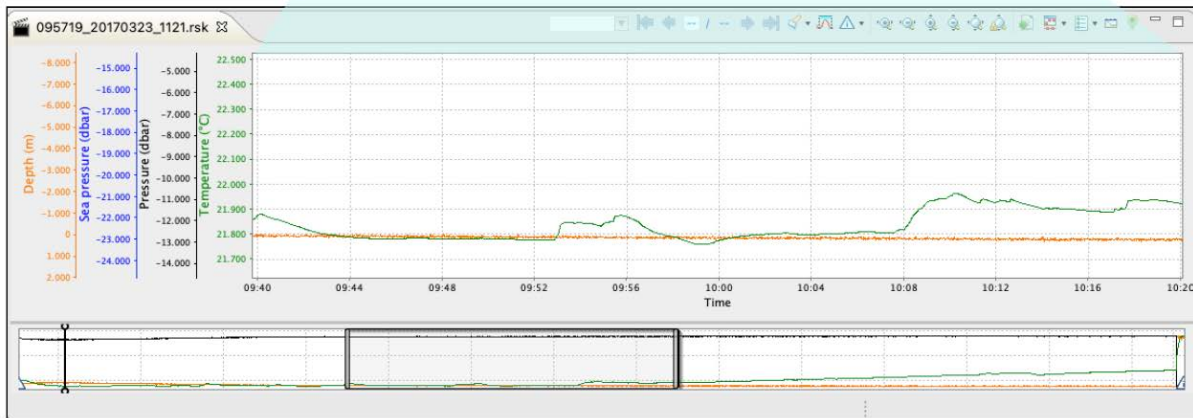
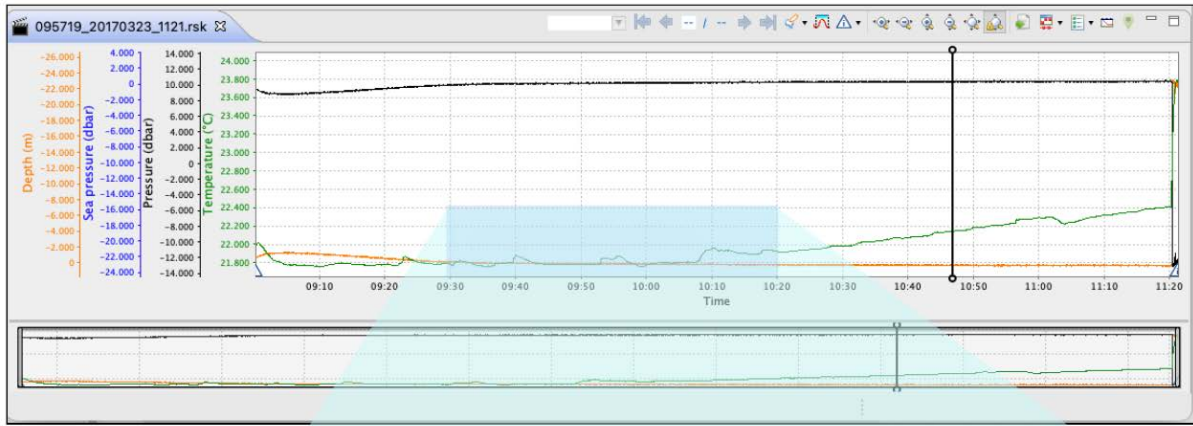

Double-click on the same vertical axis to reset this parameter.

4. To freely select any part of the chart, hold **Shift + left click** and draw the rectangle. The chart will zoom in on the selected area, both horizontally and vertically.



5. To keep all your data within the viewing window, click the **Toggle auto-ranging** button . When it is on, all profiles within the selected time section maintain their optimal vertical zoom.

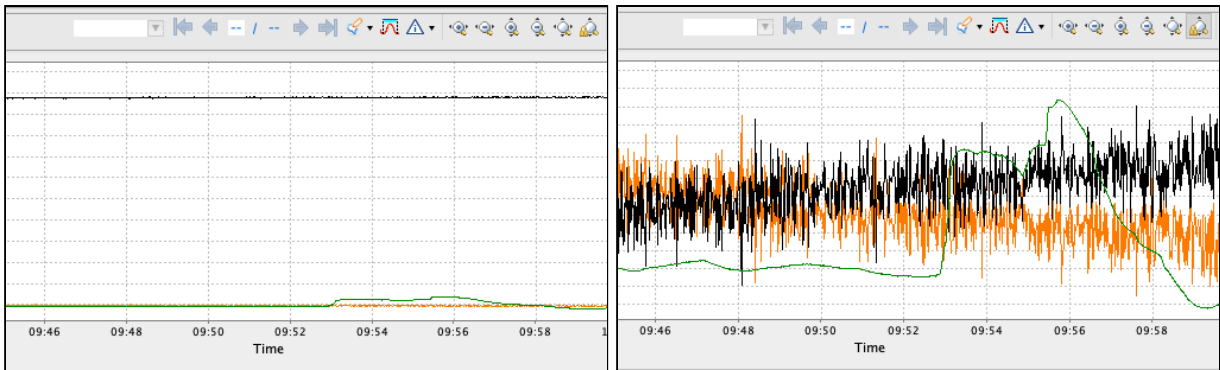

Click again to disable. Disabling the auto-ranging of the axis can be useful for looking at trends in data. Zooming in or out of an individual channel will disable auto-ranging for that channel.

6. To zoom in to the range of an annotation, double-click on the annotation bar.



Click **Reset zoom to maximum bounds**  or **double-click** anywhere on the chart to restore the original appearance.

## 17.4.4 Advanced axis controls

Some RBR instruments have multiple parameters of the same type. For example, your RSK file from the RBR*concerto*<sup>3</sup> Tx could have 12 or 24 temperature channels and from the RBR*quadrante*, up to four irradiance channels.

By default, Ruskin will use a single axis to display similar channels. To display each similar channel on its own axis, go to **Preferences > Plotting > Channel visibility**. Deselect the **Use single axis for similar channels** checkbox.

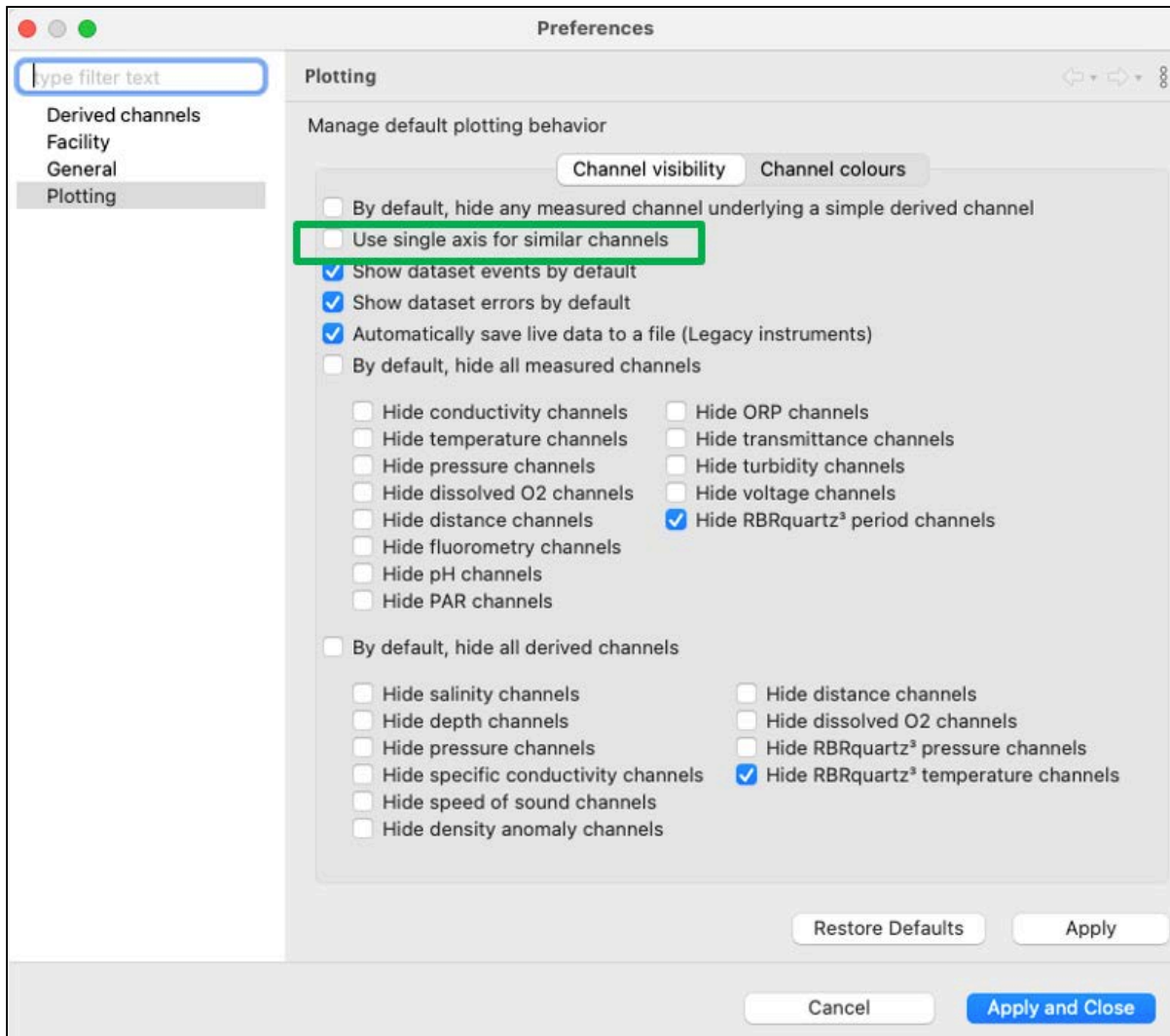

Click **Apply and close**. These changes will automatically apply to every new dataset. To apply your changes to an active dataset, close it and then re-open.

Both views have their advantages. Below, compare the two displays of the same dataset obtained using an RBR*quadrante*.

### Default settings: single axis

The chart displays four irradiance channels and one irradiance axis. The axis is grey, while the traces related to this single axis remain colour-coded.

With the axis panel collapsed, you have a broad view of the chart.

All four channels have the same scale, which in the example below is  $0\text{-}5.500\mu\text{W}/\text{cm}^2/\text{nm}$ . Vertical zoom controls, if used, are applied to all these traces as a group.

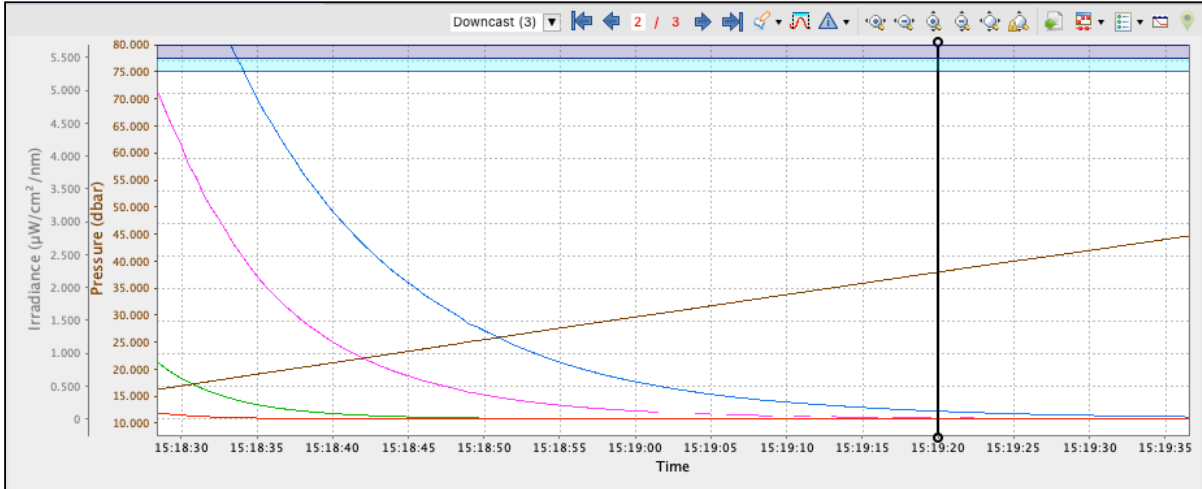

### Customised settings: multiple axes

The chart has four irradiance channels and four axes, each identified with the same colour as the trace. The corresponding wavelength and FWHM will also be displayed; in this example: **560/10**, **488/10**, **445/10**, and **413/10**.

Each channel has its optimal vertical scale. In the example below, the scale for the **560/10** is  $0\text{-}9.000\mu\text{W}/\text{cm}^2/\text{nm}$ , while for the **413/10** it is  $0\text{-}0.100\mu\text{W}/\text{cm}^2/\text{nm}$ .

To adjust the vertical scale for each channel individually, hover the cursor over an axis and scroll your mouse wheel up and down. See [Vertical zoom](#) for other ways to adjust the scale.

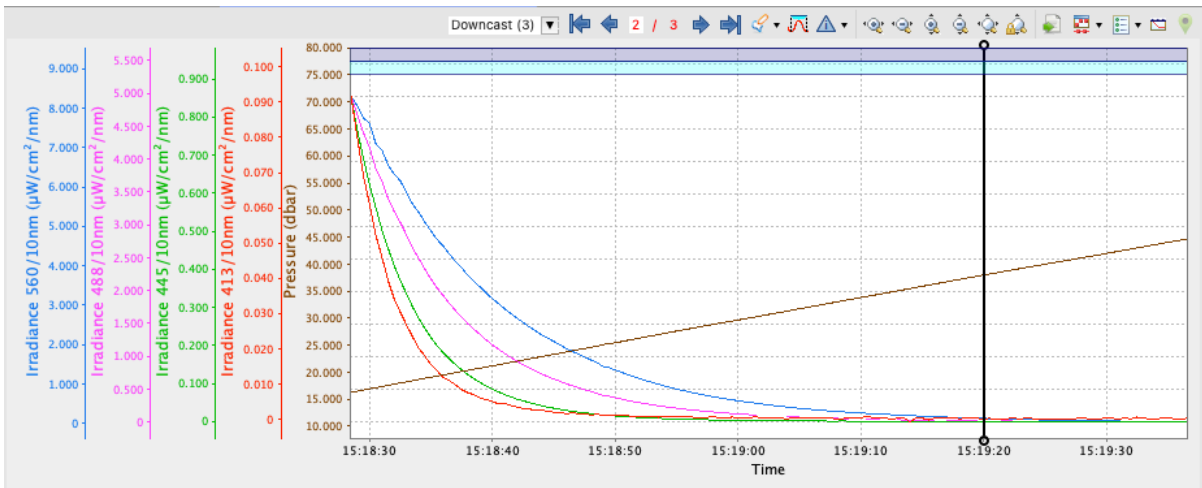

Regardless of the view (single axis or multiple axes), the channel table in the **Analysis** tab retains individual colours for all channels, matching the colour-coding of the traces in the **Plot** window.

7 Irradiance 413/10nm	4.9941950	$\mu\text{W}/\text{cm}^2/\text{nm}$
8 Irradiance 445/10nm	11.2594115	$\mu\text{W}/\text{cm}^2/\text{nm}$
9 Irradiance 488/10nm	18.3235068	$\mu\text{W}/\text{cm}^2/\text{nm}$
10 Irradiance 560/10nm	15.9567764	$\mu\text{W}/\text{cm}^2/\text{nm}$

✔ To change the colour-coding settings for your chart, go to **Preferences > Plotting > Channel colours**.

## 17.5 Export plot

Click the **Export plot** button  and select file name and location to save the current view of the main plot to a PDF or PNG file. The exported file will contain the graph only and retain all the changes to display active at the moment of export: zoom, lines and markers, visible events and annotations, and plotting by depth or time.

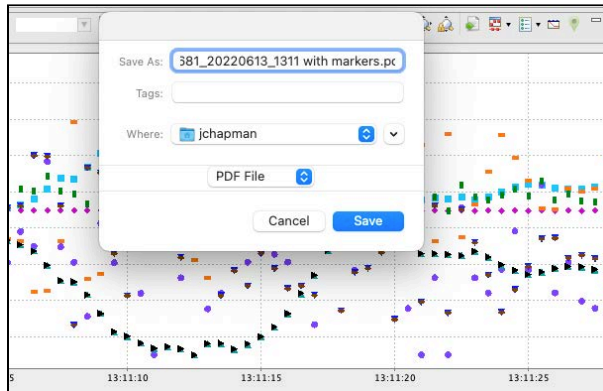

## 17.6 Appearance controls

Select your data rendering type from the **Change line type** dropdown menu : **Lines**, **Markers**, or **Lines and markers**.

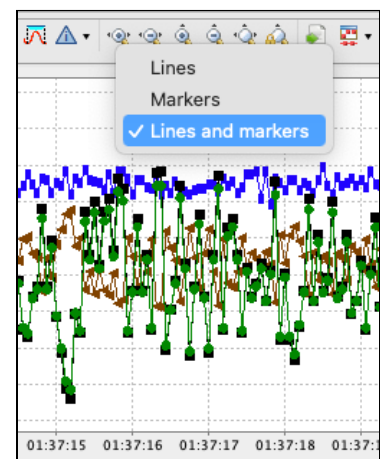
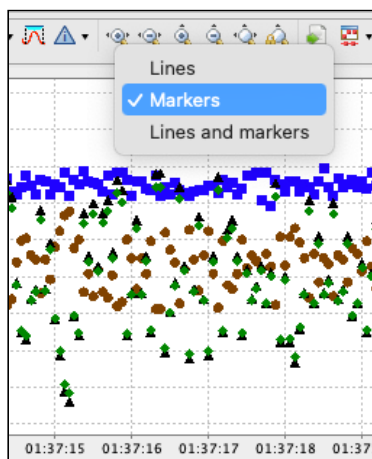
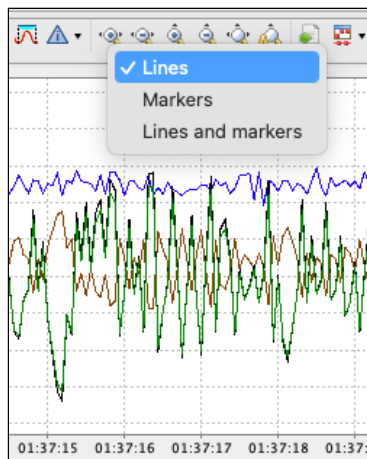

✔ If no data appears in the **Plot** view, try changing the rendering to **Markers**. Time spans that are larger than expected will cause breaks between data points and lines will not be drawn connecting those points, whereas markers draw at each individual point.

Use the **Toggle channel visibility** button  to open the dropdown menu with the list of available channels and options. Check and uncheck channels to display as desired, or select groups to show and hide.

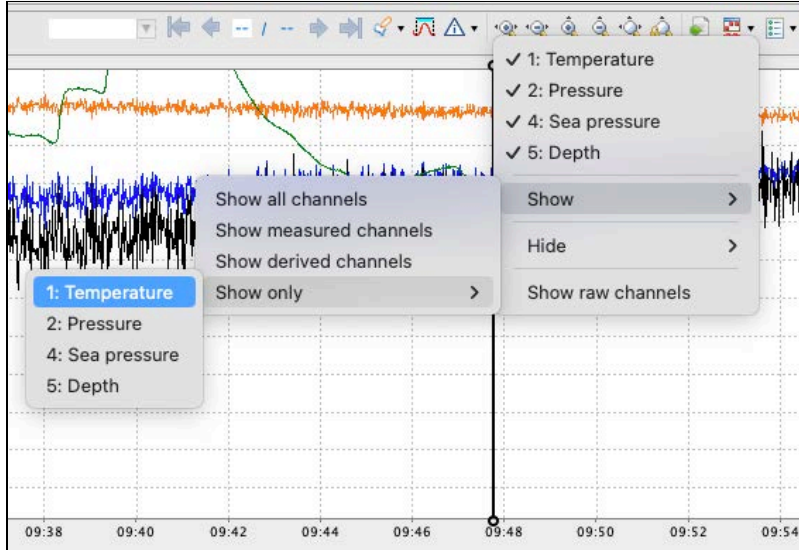

Select **Show raw channels** to display measured data with no calibration equations applied.

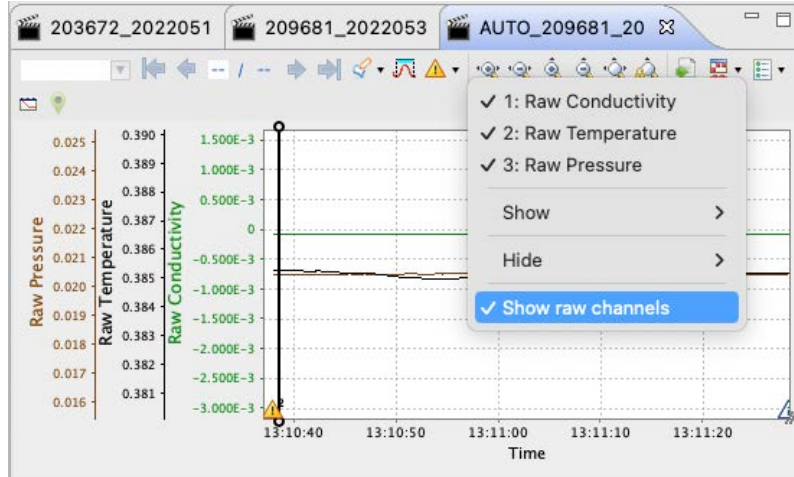



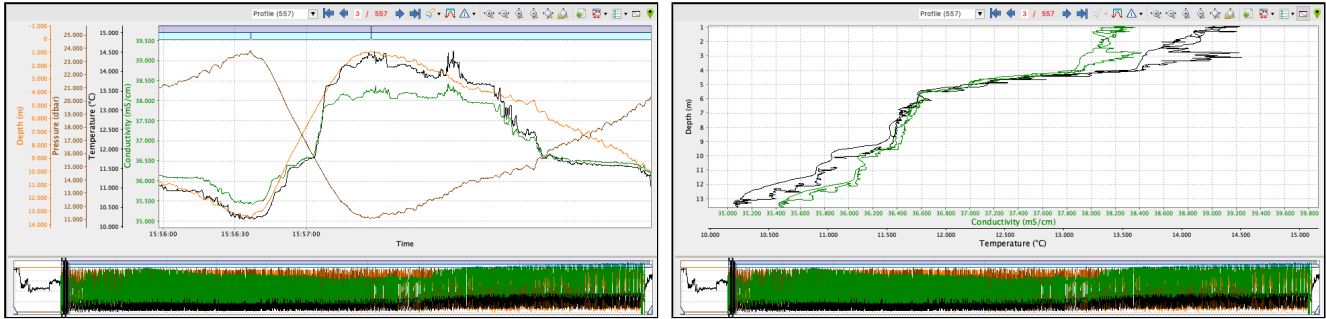

By default, the data are plotted by time. Use the **Toggle depth plot**  button to switch to the plot-by-depth mode.



The thumbnail view will continue to display the plot-by-time data.

 If there is no depth channel, the plot will use the next pressure or pressure-derived channel starting from the bottom of the channel list.

## 17.7 GPS map

The **Show GPS map** button  opens a pop-up window with the GPS map for the plot. Click on the map to display all the GPS location annotations recorded in the dataset.





GPS mapping for **Desktop** RSK files relies on manually added location points (see **Annotation controls**). All location points you added using the **Annotations** feature are stored in the dataset file and can be displayed in Ruskin via the mapping functionality.

 Charting and continuous GPS tracking are only available on the **Ruskin Mobile app**, for datasets in the **Mobile** storage format.

## 18 Live data plot toolbar

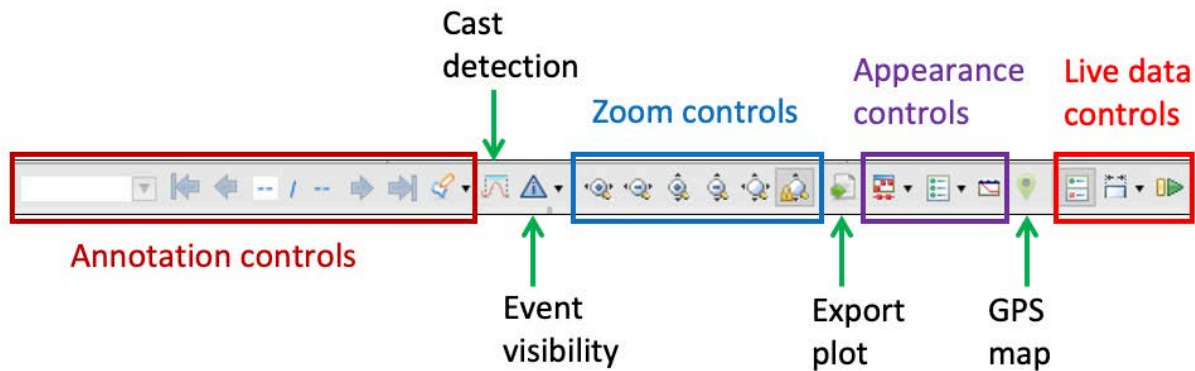
You can use the **Plot** window to view a live graphical display of your instrument sampling. All options described in the **Dataset plot toolbar** section apply to live data display. Additionally, three live data buttons appear at the right end of the toolbar: **Side data panel**, **Live plot time range**, and **Fetch**.



Click the **Side data panel** button  to toggle on and off the data panel to the right of the plot. It shows the file location that will be used to capture samples, the number of samples collected, the values of the last received sample, and the currently selected sample.

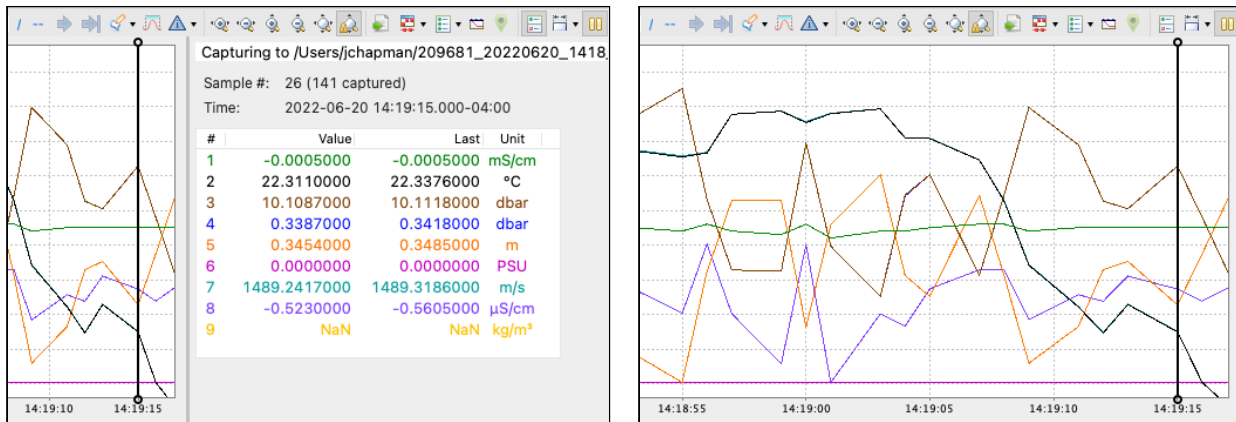

Click the **Live plot time range** button  to open a dropdown list of time span options.

For example, select **2 minutes** to display the data in the thumbnail view and on the side panel by two-minute time periods.

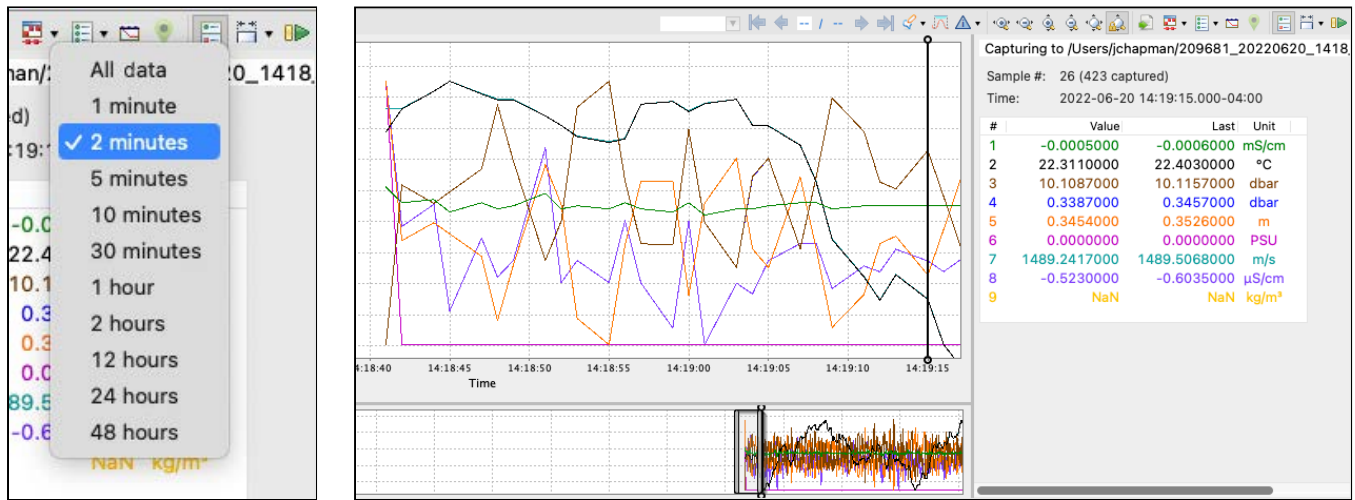



You can also choose to display all of the data collected.

## Fetching

Live data can come from one of two sources: streaming or fetching.

Fetching is the action of asking the instrument to take a reading and report it.

Fetching can be used on an instrument that is either not enabled or enabled without a streaming option. To disable the streaming option, go to [Options](#) under the **Configurations** tab and set **Realtime** to **None**.

Click the **Fetch** button  to start fetching data. The button will change to **Pause** . Click the **Pause** button  to stop fetching.

 If streaming is selected (**Realtime** is set to **Serial** or **USB**), clicking the **Fetch** button  will have no effect on the plot.

If the instrument is fetching data, but you want to start streaming, go to [Options](#) under the **Configurations** tab and set **Realtime** to **Serial** or **USB**, then click **Enable**. A warning message will appear.

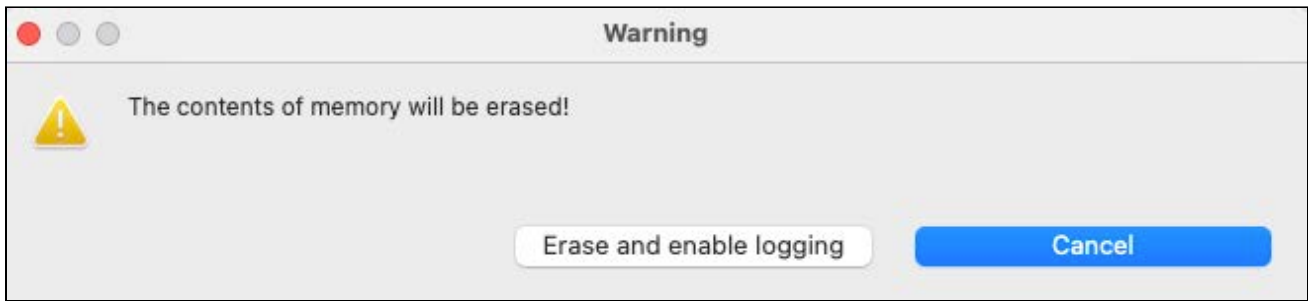

To save the fetched data, click **Cancel** and download the dataset file. Otherwise, click **Erase and enable logging**. Ruskin will disable fetching, close the current dataset used for the fetched data, and create a new file for the streamed data. A new streaming plot will appear. Click the **Pause** button  to freeze the view of live data.

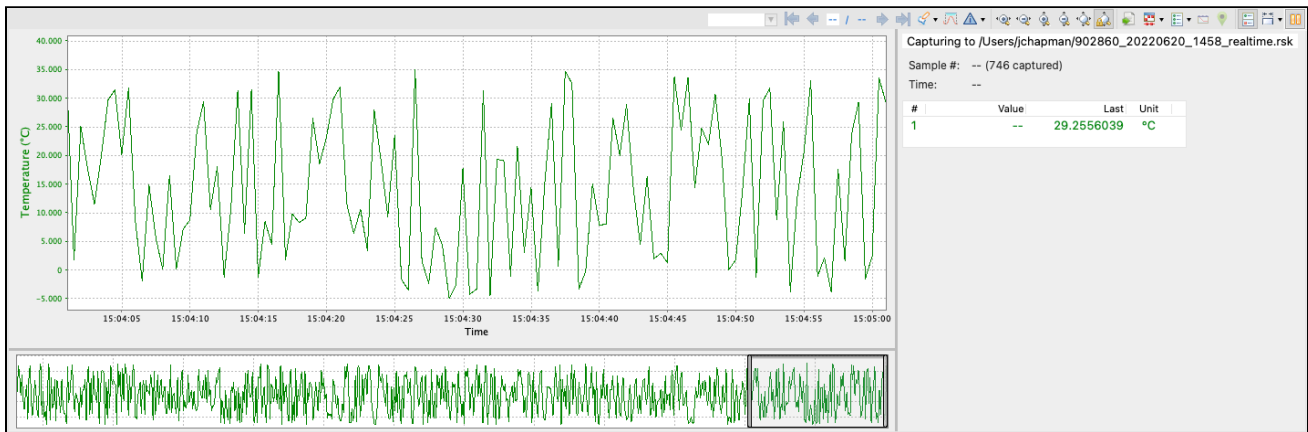

# 19 Firmware updates

Ruskin automatically checks if your instrument firmware is up-to-date. Updates may be critical, routine, or customised.

## 19.1 Critical firmware updates

If a newer version is available and this update is critical, the **Update firmware** button and a warning message will appear at the top of the **Configuration** tab.

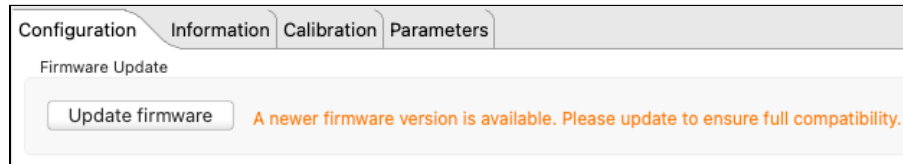

### Steps

1. Click **Update firmware**.

The **Update logger firmware** window will appear. It will contain **Release notes**, outlining the new version number, its release date, improvements, and bug fixes associated with this release, and two standard buttons at the bottom of the window: **Close** and **Proceed**.

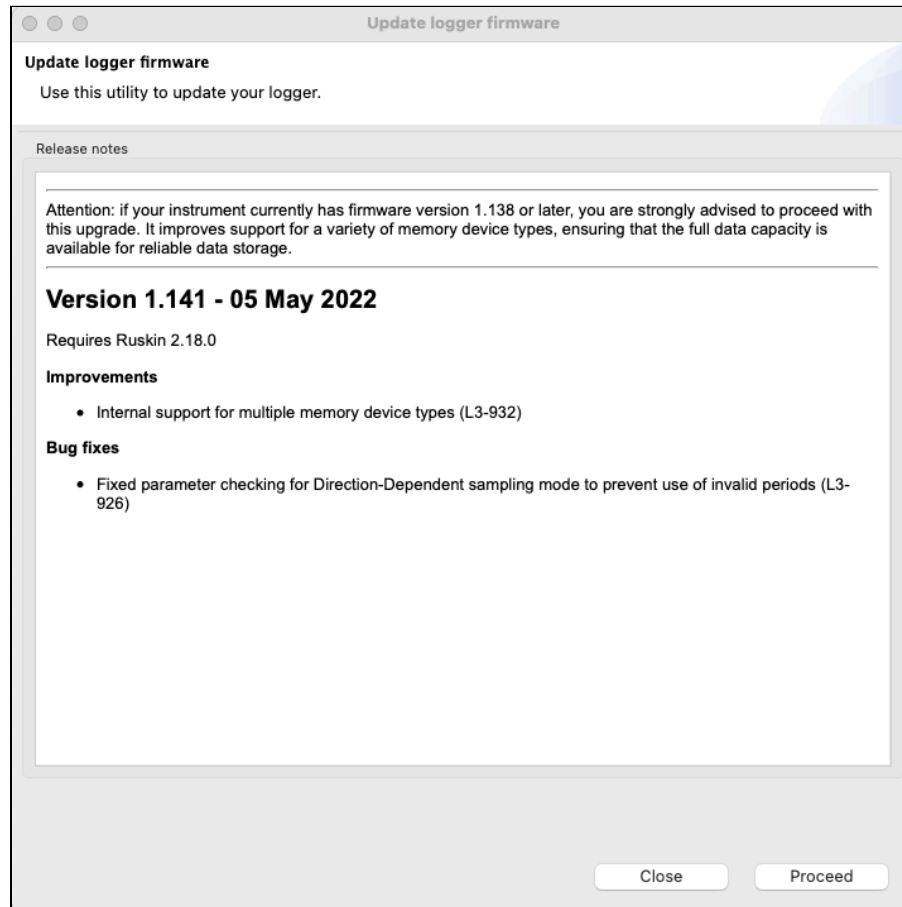

- Click **Proceed** to initialise the update.  
The instrument will disappear from the **Navigator** window during the upgrade. Watch the progress bar at the bottom of the window for the status.

⚠ Do not disconnect the instrument until a confirmation message is displayed. Disconnecting during the update process may render the instrument inoperable.

If the upgrade does not complete successfully, go to the **Instruments** menu and launch the update dialogue.

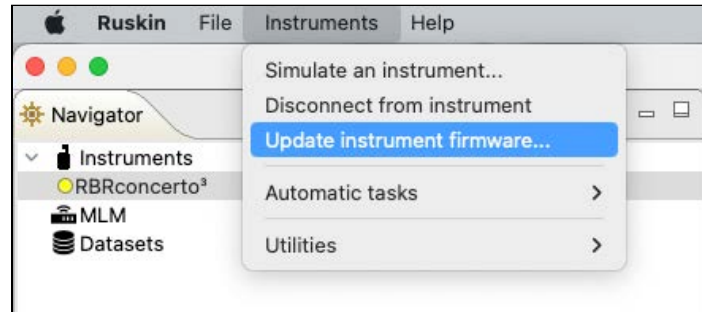

The **Update logger firmware** window will appear. Click **Proceed** again to retry.

If the instrument does not reappear in the **Navigator** window after a firmware update, disconnect your instrument from the USB port and then reconnect to establish communication.

## 19.2 Routine firmware updates

If the latest update is not critical, Ruskin will not display any warning message. However, you can always check manually if a newer firmware warning is available.

Go to **Instruments > Update instrument firmware**.

The **Update logger firmware** dialog box will appear. In addition to the new version number, its release date, improvements, and bug fixes, there will be two additional sections: **Select the instrument to update** and **Select the firmware image**.

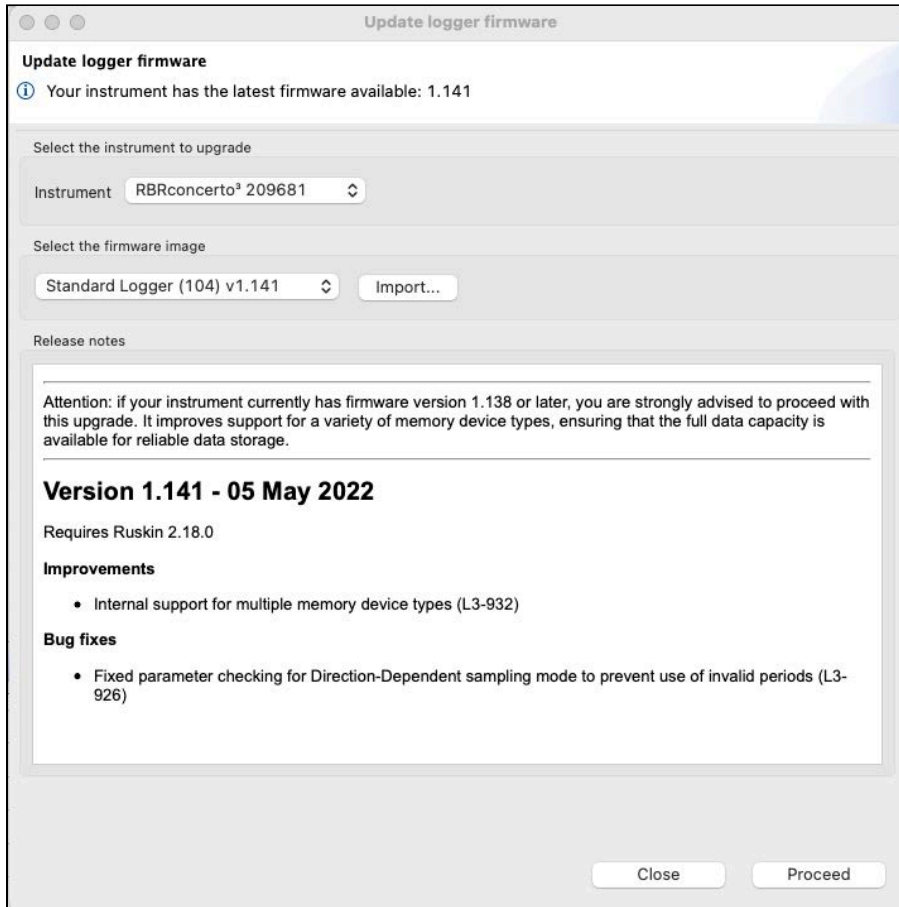

## Steps

1. From the **Instrument** dropdown, select the instrument you wish to upgrade.

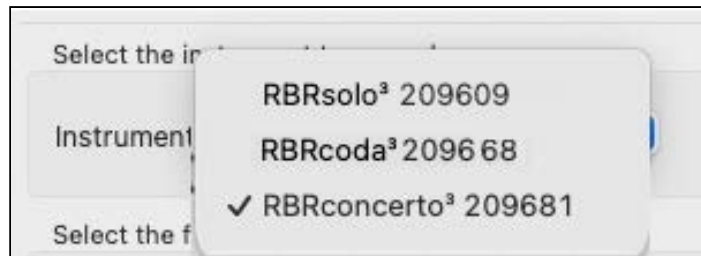

- From the next dropdown, select the latest firmware image.

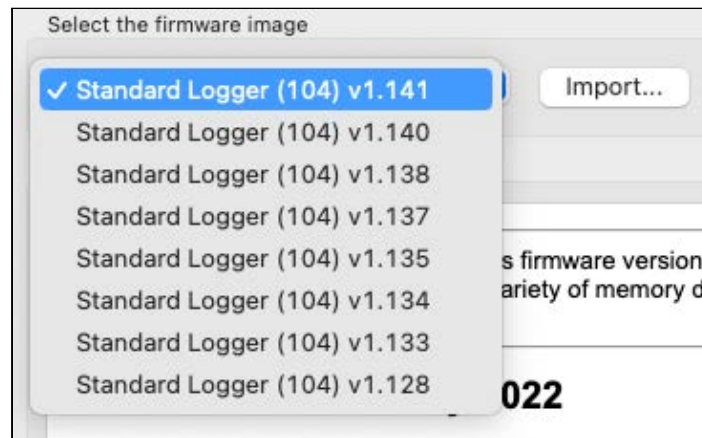

- Click **Proceed** to initialise the update. The instrument will disappear from the **Navigator** window during the upgrade. Watch the progress bar at the bottom of the window for the status.

 Do not disconnect the instrument until a confirmation message is displayed. Disconnecting during the update process may render the instrument inoperable.

If the upgrade does not complete successfully, click **Proceed** again to retry.

If the instrument does not reappear in the **Navigator** window after a firmware update, disconnect your instrument from the USB port and then reconnect to re-establish communication.

## 19.3 Manual firmware updates

In certain cases, RBR may supply a customised firmware version, which will not be on the dropdown list.

Go to the **Instruments** menu and launch the update dialogue.

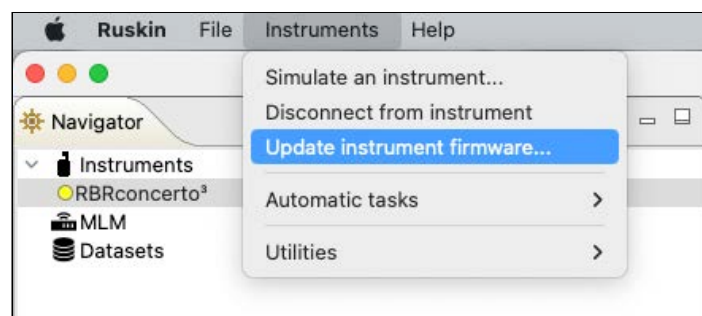

The **Update logger firmware** dialog box will appear. Follow the steps below to import the firmware image provided by RBR and update your firmware.



## Steps

1. In the **Update logger firmware** dialog box, click **Import**.



2. Browse to the location of the firmware update file. The file will have the extension **.rbfw**.
3. Select the file and click **Open**.  
The file will appear on the dropdown list.

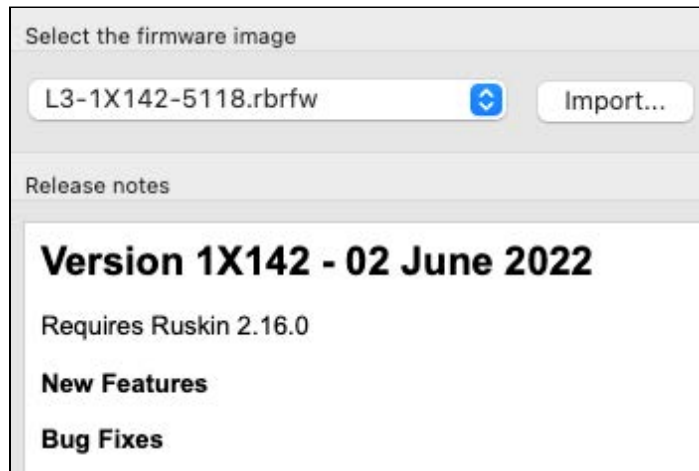

4. Click **Proceed** to initialise the update.  
The instrument will disappear from the **Navigator** window during the upgrade. Watch the progress bar at the bottom of the window for the status.

 Do not disconnect the instrument until a confirmation message is displayed. Disconnecting during the update process may render the instrument inoperable.

## 20 Automatic tasks

When working with a large number of similar instruments, Ruskin offers various automatic tasks.

When using this feature, you will configure your schedule once and then automatically apply the settings to multiple instruments.

 Automatic tasks do not work with wi-fi connected instruments.

Access these options from the **Instruments** menu on the top toolbar.

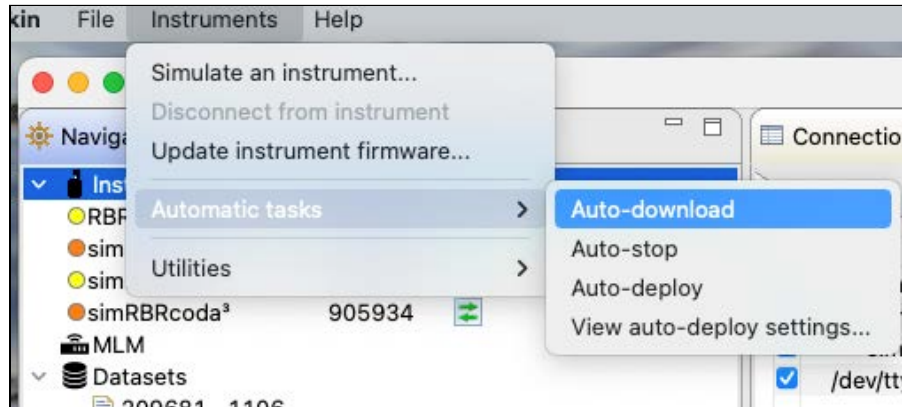

Alternatively, right-click **Instruments** in the **Navigator** window.

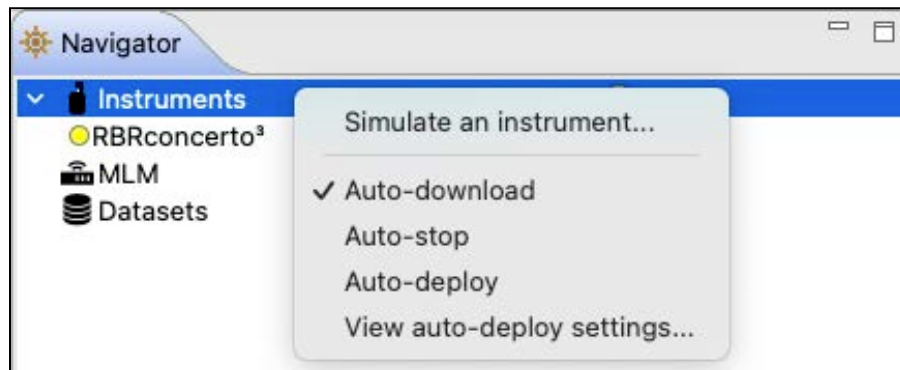

When you enable a task, it will show a checkmark next to it, and the corresponding icon will be displayed in the **Navigator** window.

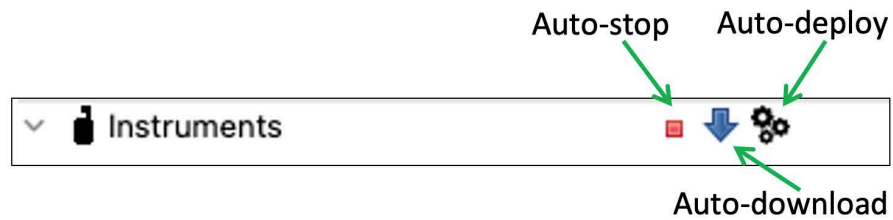

Since these tasks can change the state of your instrument, their settings default to "off" each time Ruskin is run. When an automatic task is on, Ruskin will execute it as soon as you plug an instrument into your computer.

### Auto-download

When Ruskin detects an instrument, it will automatically start a download process. The downloaded dataset will be named following the [standard naming convention](#), and saved in the [default directory](#). Other than possibly creating unwanted files, this option is safe since it does not alter the state of the instrument.

### Auto-stop

When Ruskin detects a previously enabled instrument, it will automatically stop the deployment. If auto-download is not selected, it will also display a warning about downloading the instrument data.

Use this feature when [Gating](#) is set to **None**.

**⚠** All the data on the instrument will be erased as soon as you enable a new deployment. RBR recommends enabling the **Auto-download** feature whenever you enable **Auto-stop**.

### Auto-deploy

When Ruskin detects an instrument, it will stop the deployment and then reprogram your instrument with the last known configuration settings. Use this feature when you have several instruments with the same capabilities.

**⚠** All the data on the instrument will be erased as soon as you enable a new deployment. RBR recommends enabling the **Auto-download** feature whenever you enable **Auto-deploy**.

To use this feature, follow these steps:

1. Connect to an instrument that will act as the model.
2. Configure this instrument with the desired settings.
3. Enable **Auto-deploy** as shown above.

Now, when you connect to an instrument with same capabilities as the model instrument, Ruskin will configure it to match the the model schedule.

**⚠ Auto-deploy implies Auto-stop.**

Ruskin must stop your instrument to change deployment parameters, so it will stop even when there is no checkmark next to the **Auto-stop** task.

### View auto-deploy settings

To view the currently active auto-deploy parameters, go to **Instruments > View auto-deploy settings...** . The **Auto-deploy settings** box will open, with saved parameters outlined.

Setting	Value
ALTITUDE	0.0000
ATMOSPHERE	9.7700000
AVERAGE_SPEED_OF_SOUND	1550.7440
CAST_DETECTION	on
CONDUCTIVITY	42.914
DENSITY	1.0000000
SIMPLIFIED_DEPTH_CALCULATION_TYPE	on
DISSOLVED_O2_GENERIC_UNIT	mg/L
DISSOLVED_O2_OPTODE_UNIT	uMol/L
DISSOLVED_O2_OXYGUARD_UNIT	mg/L
DISSOLVED_O2_RINKO_UNIT	mg/L

## 21 Utilities

 The **Utilities** option is a support tool. Contact [RBR](#) before using it.

From the **Instruments** menu, click **Utilities**. A dropdown menu will open.

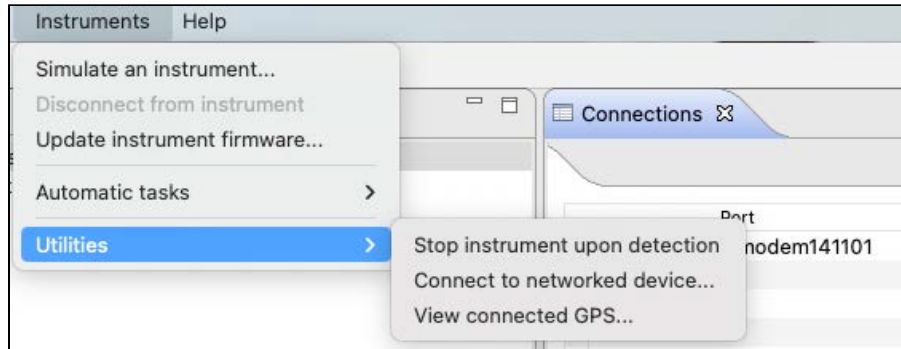

### Stop instrument upon detection

This is an emergency utility which provides a solution to a rare issue with some legacy instruments. Do not use unless instructed by RBR.

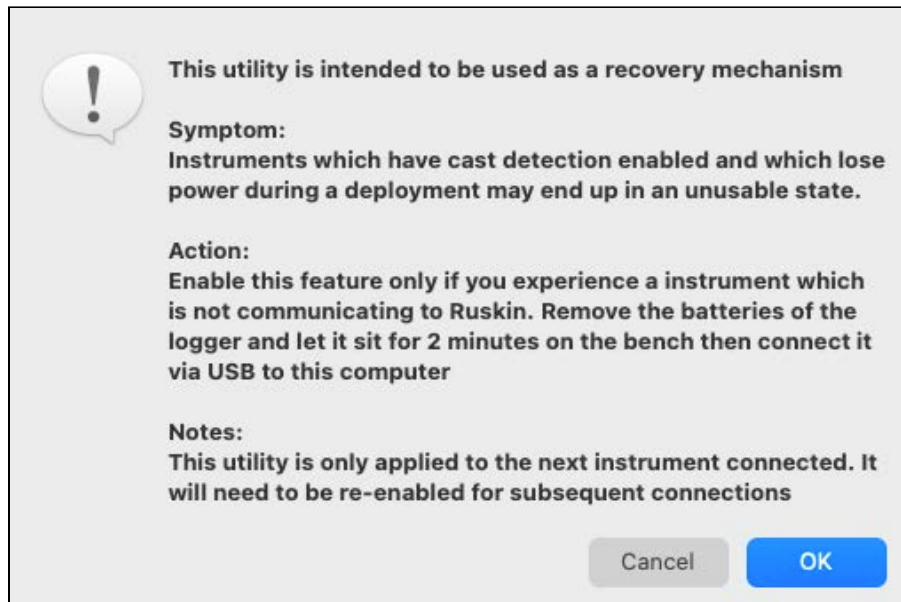

### Connect to networked device...

This utility allows a device with serial output to connect to your network via Ethernet. This feature supports remote management and monitoring of your instruments from anywhere in the world.

1. Select your network device from the dropdown list.

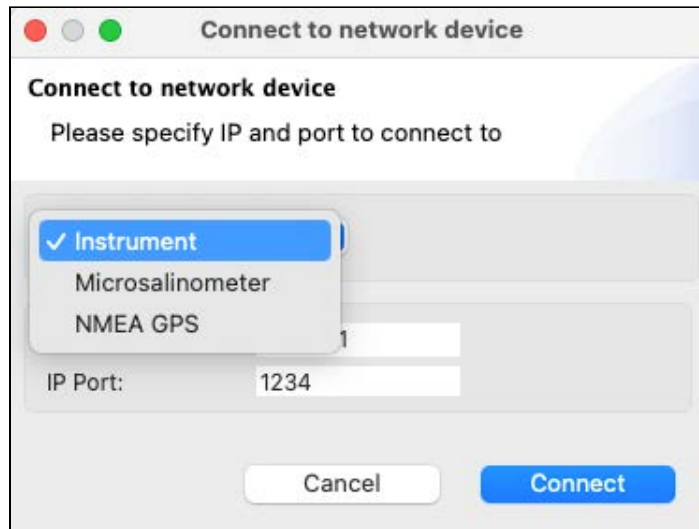

2. Specify the IP address and port.

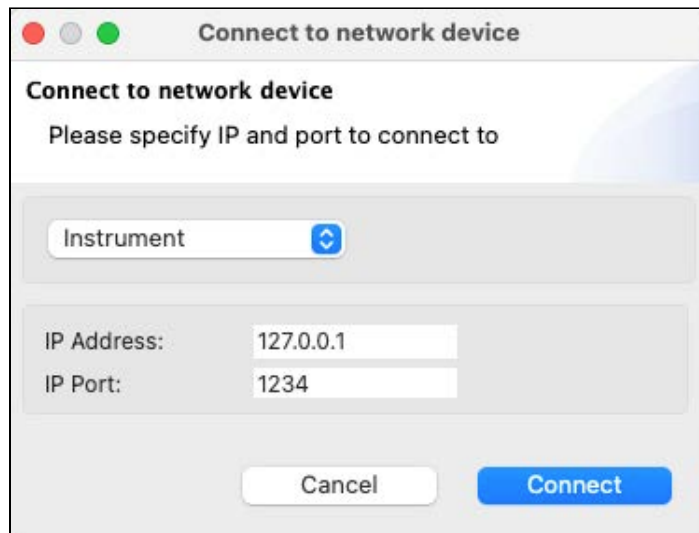

 For the microsalinometer, the port number must be **23**.

3. Click **Connect**.

The **Connections** tab will display instruments and salinometers connected via Ethernet, alongside with the instruments physically plugged in to your computer. Their IP address and port will appear in the **Port** column. If an attempt to connect was unsuccessful, Ruskin will report an error in the **Status** column.

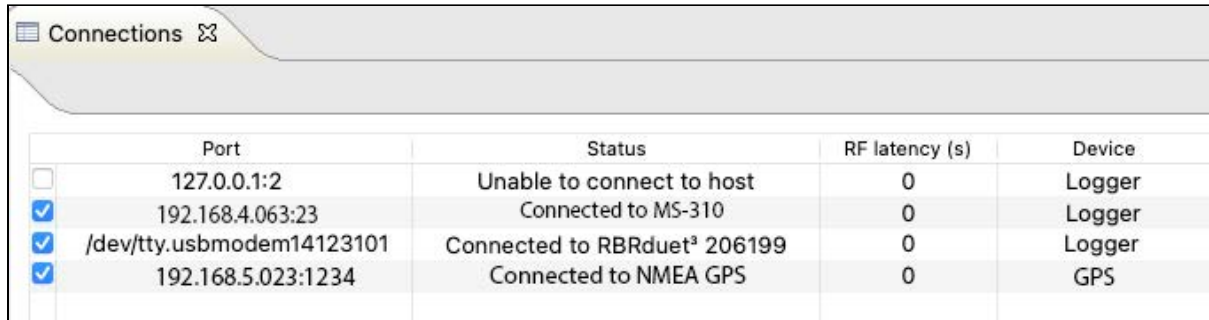

	Port	Status	RF latency (s)	Device
<input type="checkbox"/>	127.0.0.1:2	Unable to connect to host	0	Logger
<input checked="" type="checkbox"/>	192.168.4.063:23	Connected to MS-310	0	Logger
<input checked="" type="checkbox"/>	/dev/tty.usbmodem14123101	Connected to RBRduet <sup>3</sup> 206199	0	Logger
<input checked="" type="checkbox"/>	192.168.5.023:1234	Connected to NMEA GPS	0	GPS

To view connected GPS devices, go to the next utility.

**View connected GPS...**

This feature allows you to track your instruments during towed deployments. Attach a NMEA GPS to your computer and connect to it as described above. Alternatively, connect to one of the boat tracking devices if it has an IP address.

Typically, only one GPS is necessary to track your deployment. Using more than one GPS may bring confusion into your data. Click **View connected GPS...** to see all listening ports. Click the **Port** button to disconnect.

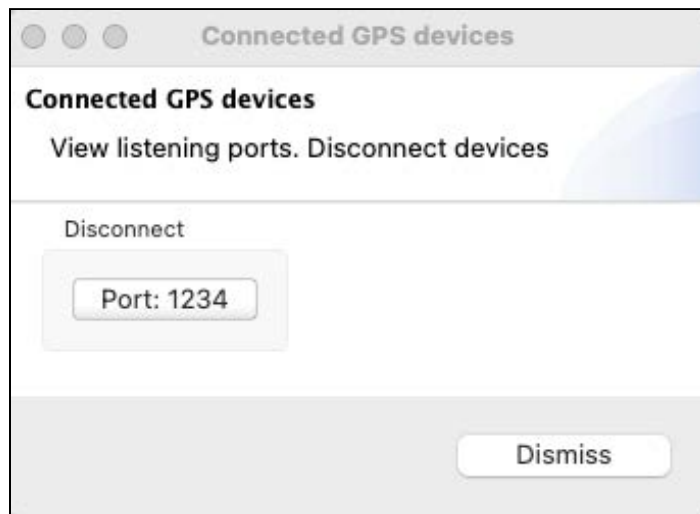

## 22 User calibration

Factory calibration coefficients are calculated for each sensor, and the coefficients are stored on the instrument.

RBR calibration certificates contain calibration equations, coefficients, and residuals for each sensor. Hard copies are provided with each shipment. RBR can replace lost or misplaced calibration certificates upon request.

RBR recommends calibrating your instrument before any critical deployment, periodically once a year, or if you suspect the readings to be out of specifications.

Discuss your calibration requirements with RBR. In some cases, the instrument will need to be returned to RBR to have it checked and re-calibrated.

Please contact [RBR](#) for our current calibration fees.

View current calibration coefficients for your sensors under the [Calibration](#) tab in the **Properties** window.

Sensors such as dissolved oxygen, turbidity, pH, and fluorescence can be field-calibrated. Update the calibration coefficients for these channels periodically. On occasion, you may need to manually enter new coefficients, although this is not recommended for factory-calibrated sensors (for example C, T, or D) unless instructed by RBR.

 Use only datasets in the **Desktop** storage format to calibrate the sensors. The **Calibration** tab is not available for RSK files in the **Mobile** storage format.

To calibrate a sensor, you need to let it sample in a known environment and then compare the result to the established value. The difference will be used to generate calibration coefficients. With the **N**-point method, the known environment is changed **N** times. The higher the **N**, the more accurate are calibration coefficients.

Use the **Calibration** button under the **Analysis** tab to calibrate turbidity, pH, fluorescence, and Oxyguard DO sensors.

Use the **Plot** window to calibrate the RBR*coda*<sup>3</sup> T.ODO integrated sensors.

### 22.1 Dissolved oxygen sensor calibration

 Use only datasets in **Desktop** storage format to calibrate the sensors. The **Calibration** tab is not available in **Mobile** mode.

Dissolved oxygen sensors manufactured by RBR are available as the RBR*coda*<sup>3</sup> T.ODO and can be integrated in any RBR standard instrument. Additionally, RBR standard instruments support several third-party dissolved oxygen sensors (OxyGuard, Rinko, and Aanderaa).

For dissolved oxygen sensors, RBR recommends user calibration using the **N**-point method, with **N** = 2, which will include a **zero reference point** and a **non-zero reference point**. It is, however, acceptable to perform a one-point calibration.



## 22.1.1 Dissolved oxygen data collection

Follow the steps below to obtain the calibration dataset for your dissolved oxygen sensor.

### Equipment and materials

- A wide-mouth, black-walled container with a cover
- A small container or beaker
- Air pump (for example, an aquarium air pump with a stone bubbler)
- Magnetic stirrer
- Sodium sulphite  $\text{Na}_2\text{SO}_3$
- Distilled water

### Ruskin configuration

1. Go to [Configuration](#).
2. Select **UTC** or **Local**, depending on your preferences, to synchronise the instrument clock with your computer.
3. Set the sampling rate at 1s (1Hz).
4. Enable your schedule.

 The instrument must be logging throughout the calibration procedure.

### Non-zero reference point

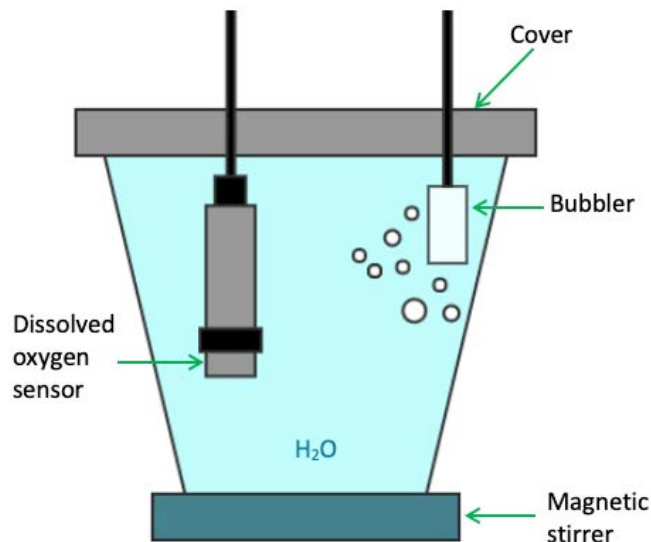

1. Fill the black-walled container with distilled water.
2. Install the magnetic stirrer.
3. Install the air pump.
4. Switch on both the air pump and the magnetic stirrer.

5. Leave them on overnight, or for at least 3-4 hours, to achieve saturation.
6. Submerge the dissolved oxygen sensor in the solution, going in at an angle and stirring to avoid bubble buildup on the sensor window.  
Leave some space between the sensor and the beaker walls.
7. Position the sensor near the stirrer but not directly in the bubbles.  
The bubbler should be shallower than the sensor.
8. Record the data for at least 30 minutes.  
This is the 100% oxygen concentration calibration point.

### Zero reference point

**⚠** Omit this step when performing the one-point calibration.  
If you calibrate your dissolved oxygen sensor using the one-point calibration method at 100% oxygen concentration only, calibration should be performed at the expected temperature and salinity of the deployment environment.

1. In a small container or beaker, prepare a 0.1% solution of sodium sulphite (0.25g of  $\text{Na}_2\text{SO}_3$  for 250mL tap water).
2. Mix the solution thoroughly with a magnetic stirrer. The solution will be oxygen-free after 15 minutes.
3. Submerge the dissolved oxygen sensor in the solution, going in at an angle and stirring to avoid bubble buildup on the sensor window.  
Leave some space between the sensor and the beaker walls.

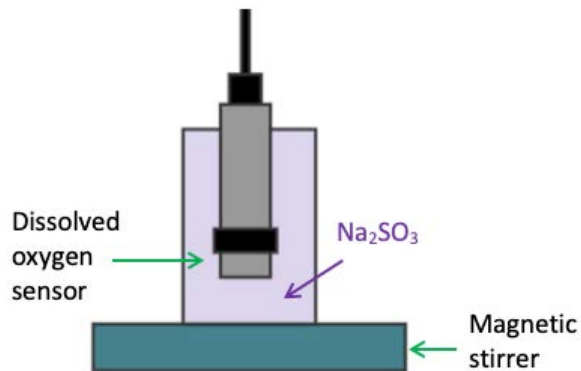

4. Record the data for at least 30 minutes.  
This is the 0% oxygen concentration calibration point.

**⚠** This  $\text{Na}_2\text{SO}_3$  solution has a limited lifespan and should not be used for more than a day.

## 22.1.2 DO calibration in Analysis tab

For DO sensors, RBR recommends a two-point user calibration, which includes a **zero reference point** and a **non-zero reference point**. It is, however, acceptable to use a one-point calibration.

### Two-point calibration steps on Ruskin

1. Stop the deployment.
2. Download the dataset.
3. Open the dataset on Ruskin. The **Properties** windows will change to dataset properties, with the **Analysis** tab displayed.

Channel	Value	Unit
Temperature	24.7980633	°C
Temperature	24.9370000	°C
Dissolved O <sub>2</sub> concentration	200.7831154	µmol/l
Oxidation/Reduction Potential	0.4742427	V
PAR	0.0245586	µMol/...
pH	10.0108701	pH_u...
Transmittance	0.5000222	trans...
Turbidity	979.7631864	NTU
Dissolved O <sub>2</sub> saturation	94.6840446	%

4. Click **Calibration**.
5. Select **Dissolved O<sub>2</sub> saturation** from the dropdown list.  
By default, the **Number of samples** is set to **100**, which means Ruskin will average the calibration coefficients over a hundred sample points. Typically, this value should be in the range from 50 to 100 samples.  
The **Raw channel** box is unchecked, and thus the true DO values will be displayed in the plot below. To see the raw voltage values, check this box.

	Avg	Std	Real Avg	Residual
<input type="checkbox"/>				
<input type="checkbox"/>				

A downsampled representation of the dataset will appear in the thumbnail view, with two distinct plateaus corresponding to 100% and 0%. Irregular readings in-between mark the times when you changed from distilled water to sodium sulphite solution and reassembled the setup.



6. Click on a stable point in the **Plot** view corresponding to 100% oxygen.

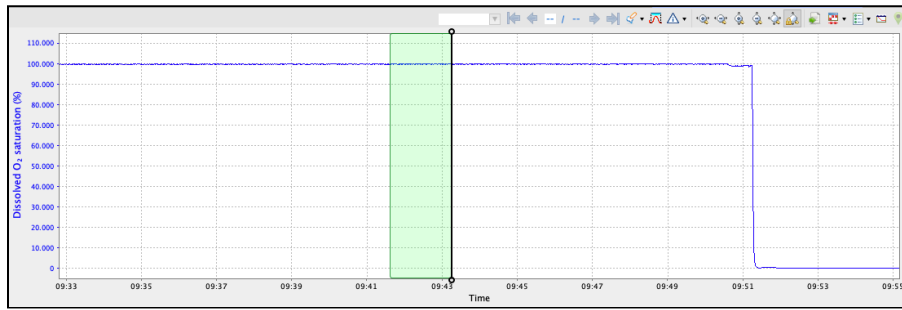

The interval of 100 samples will be highlighted. The average value (**Avg**) and standard error (**Std**) for this interval will appear in the table above.

7. Under **Real Avg** in the first row, enter **100**.

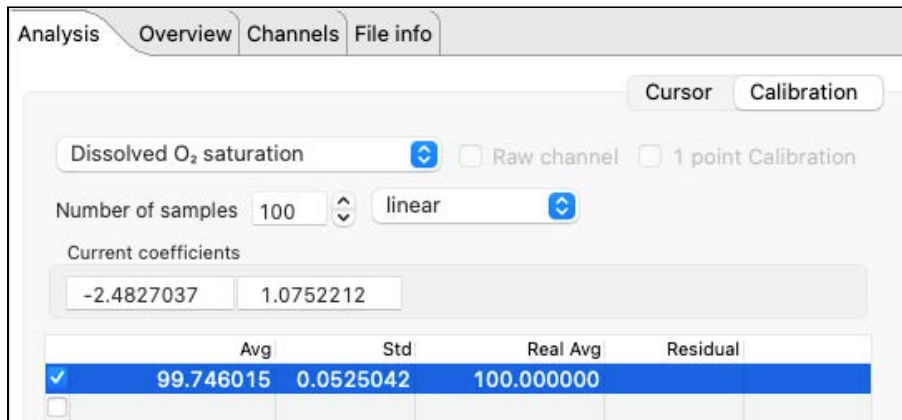

8. Repeat the same steps for the second plateau, entering **0** under **Real Avg**.

9. Ruskin automatically calculates the calibration coefficients, and the values appear in **Calculated coefficients**.

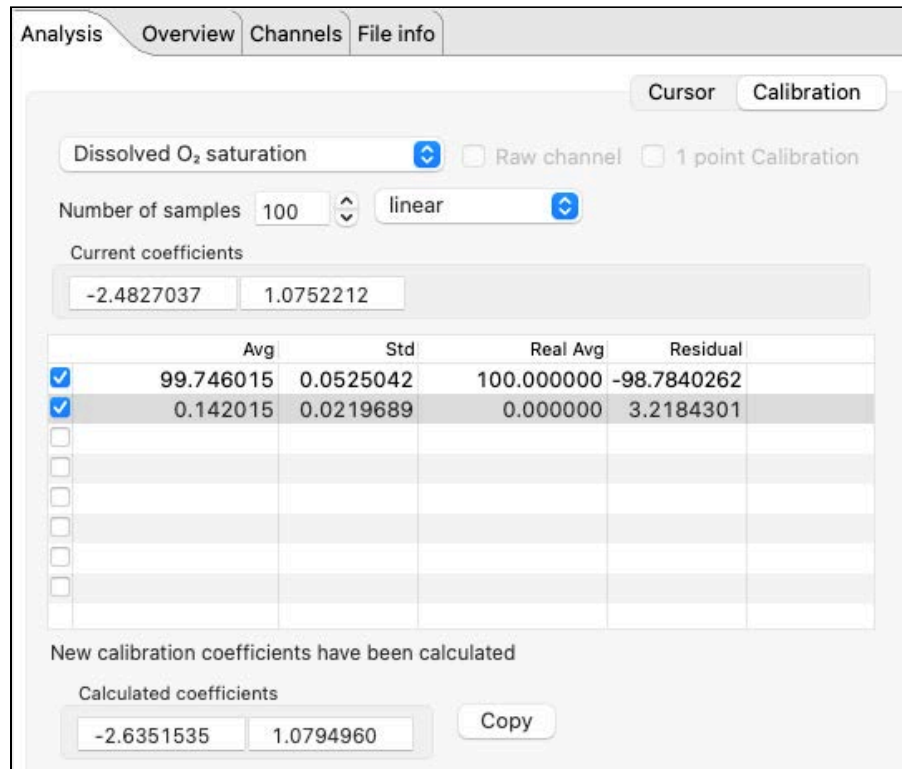

10. Click **Copy** to save the new calibration coefficients to the clipboard, or write them down.
11. In the **Navigator** view, find your instrument.
12. Click **Calibration** and select **Dissolved O<sub>2</sub> saturation** from the dropdown list.
13. Click **C0** to select the entry field and type in the new value (in this example, **-2.6351535**).
14. Click **C1** to select the entry field and type in the new value (in this example, **1.0794960**).
15. Click **Store calibration** to save the new coefficients.

**!** Always click **Store calibration** to save new coefficients on the instrument. Otherwise, all changes will be lost once your session is closed.

## One-point calibration steps on Ruskin

 If you calibrate your dissolved oxygen sensor using the single-point calibration method at 100% oxygen concentration only, calibration should be performed at the expected temperature and salinity of the deployment environment.

1. Stop the deployment.
2. Download the dataset.
3. Open the dataset on Ruskin. The **Properties** windows will change to dataset properties, with the **Analysis** tab displayed.
4. Click **Calibration**.
5. Select **Dissolved O<sub>2</sub> saturation** from the dropdown list.
6. Check the **1 point calibration** box.
7. Click on a stable point in the **Plot** view corresponding to 100% oxygen. The interval of 100 samples will be highlighted. The average value (**Avg**) and standard error (**Std**) for this interval will appear in the table above.
8. Click the **RealAvg** column and select **100** from the dropdown.
9. Click **Copy** to save the new calibration coefficients to the clipboard, or write them down.
10. In the **Navigator** view, find your instrument.
11. Click **Calibration** and select **Dissolved O<sub>2</sub> saturation** from the dropdown list.
12. Click **C0** to select the entry field and type in the new value.
13. Click **C1** to select the entry field and type in the new value.
14. Click **Store calibration** to save the new coefficients.

 Always click **Store calibration** to save new coefficients on the instrument. Otherwise, all changes will be lost once your session is closed.

### 22.1.3 ODO calibration in Plot window

**⚠** Optical dissolved oxygen sensors manufactured by RBR are calibrated using the **Plot** window. Clicking the **Calibration** button under the **Analysis** tab will result in an error message.

#### Plot calibration steps on Ruskin

Use the **Plot** window on Ruskin to calibrate an integrated RBR*cod*<sup>3</sup> T.ODO. You can choose a one-point (100% O<sub>2</sub>) or a two-point (100% and 0% O<sub>2</sub>) method.

1. Create a new calibration region.
  - Obtain the calibration dataset as described above and open it in Ruskin.
  - Click **Create annotation**  and select **Calibration** from the dropdown menu.

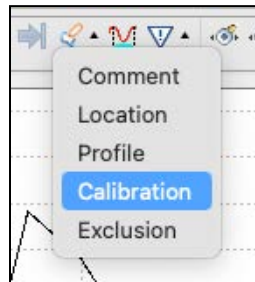

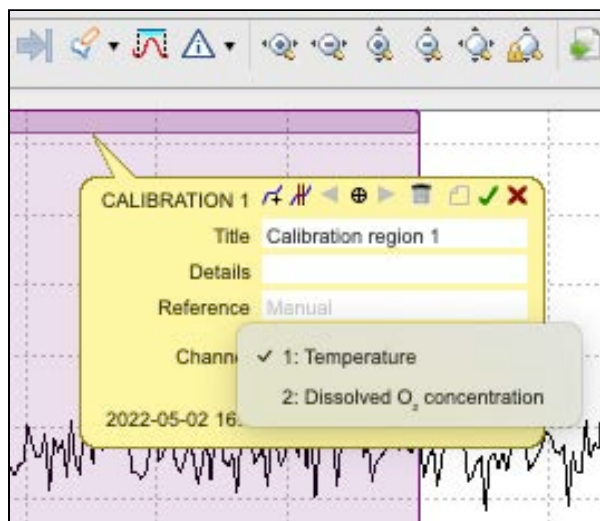

The cursor in the **Plot** window will become a two-way arrow  .

- Click and drag left or right to select the calibration region. The interval will be highlighted and a tooltip will open.
- Enter the title for the region and select **Dissolved O<sub>2</sub> saturation** from the dropdown menu.

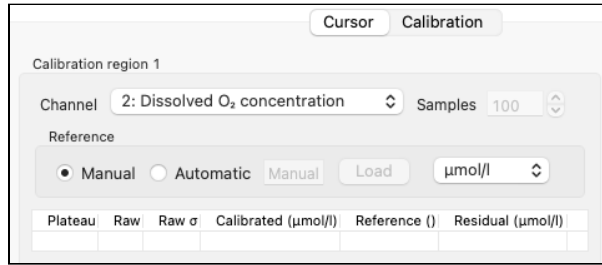

- Press **Enter** on your keyboard or click **Save**  on the tooltip to save the calibration region. A section for this calibration region will open under **Cursor**.



- To delete a calibration region, click **Delete**  on the tooltip. A warning message will appear.

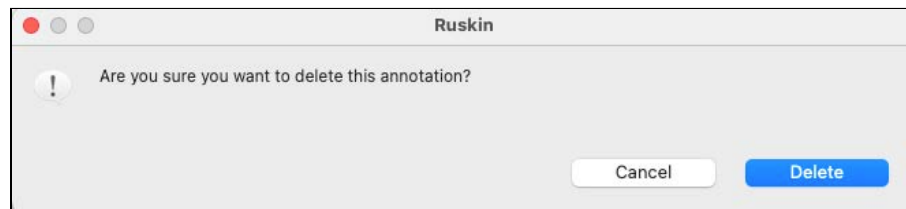

## 2. Create plateaus.

- Click **Detect plateaus**  on the tooltip to launch the automatic selection process. If there are existing plateaus, a warning message will appear.

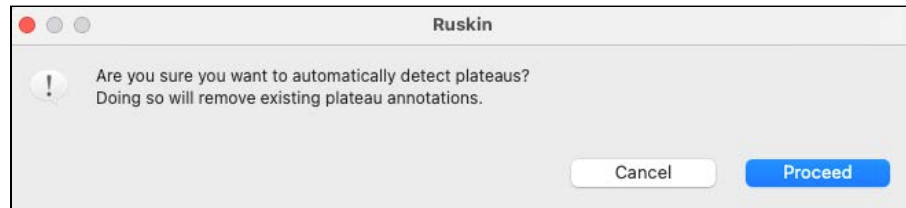

- Click **Proceed** to continue. All detected plateaus will be visible as grey markers under the calibration region marker.





- To create a plateau manually, click **Create plateaus**  on the tooltip. A new plateau will appear as a grey marker at the start of the calibration region marker. Each new click will add another plateau to the right of the existing one.

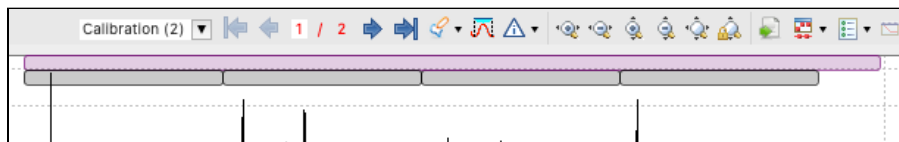

- Click a plateau to open its tooltip. You can now edit the title and add reference values.

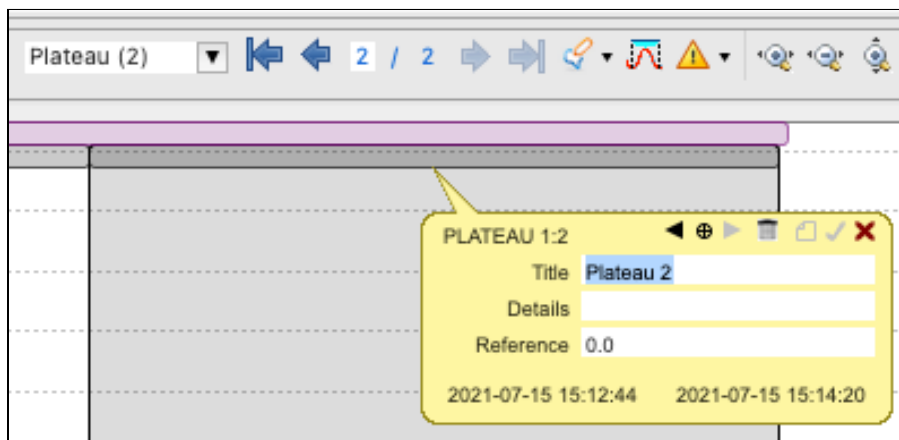

- To delete a plateau, click **Delete**  on the tooltip. A warning message will appear.

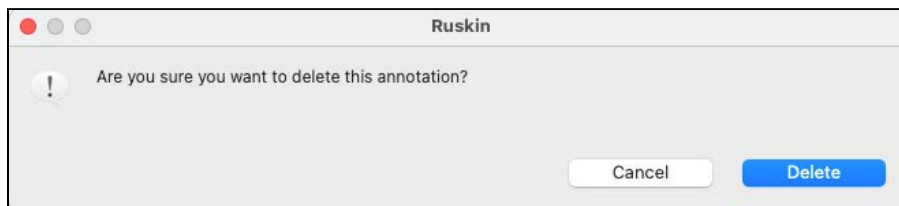

### 3. Enter reference data.

- By default, **Reference** is set to **Manual** entry mode, with in units of % or  $\mu\text{mol/L}$  available in the dropdown menu.

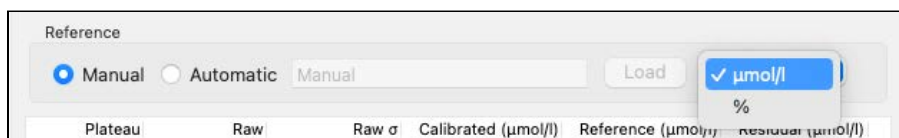

Enter the reference value for each plateau manually in the **Plateau** table under **Cursor**:

Plateau	Raw	Raw $\sigma$	Calibrated ( $\mu\text{mol/l}$ )	Reference ( $\mu\text{mol/l}$ )	Residual ( $\mu\text{mol/l}$ )
Plateau 1	0.287594	0.0005081	220.000000	220.0	-0.0000000
Plateau 2	0.286890	0.0005006	0.000000	0.000000	-0.0000000

or in the **Plateau** tooltip:

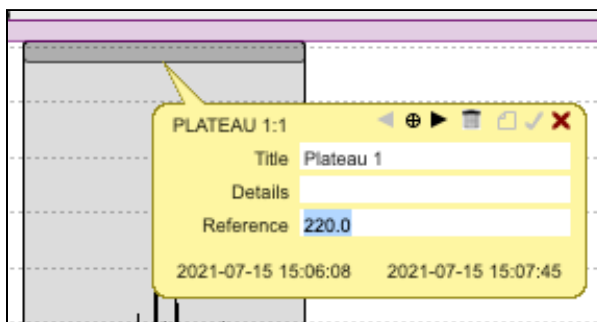

- Alternatively, enter reference values from the CSV file. The CSV file for the automatic data entry must have two columns: time (in ISO 8601 format) and data (in float/double format). For example:

```
2020-04-02T08:39:26.667-4:00, 220.0
2020-04-02T08:58:16.333-4:00, 0.0
```

Once the file has been selected, a dialogue box will appear asking for you to define which column contains the time and which contains the reference values.

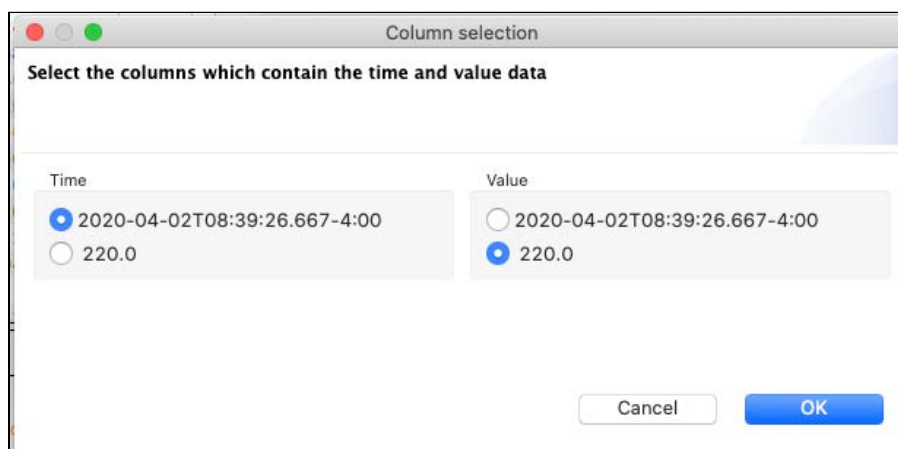

**⚠** The time in the CSV file will need to be a value that falls within the region of the plateau. However, the CSV file can hold additional rows with times that are outside of the plateau region.

#### 4. Save the coefficients.

- Verify that the calibration was successful.  
If the residuals are within an acceptable range, they will be highlighted in green, and the **Save** button will appear in the **Calculated coefficients** section.

Plateau	Raw	Raw $\sigma$	Calibrated ( $\mu\text{mol/l}$ )	Reference ( $\mu\text{mol/l}$ )	Residual ( $\mu\text{mol/l}$ )
Plateau 1	0.287577	0.0004475	220.000000	220.000000	0.0000000
Plateau 2	0.286890	0.0005006	-0.000000	0.000000	0.0000000

Calculated coefficients

C0: -91.8666377E3  
C1: 320.215203E3  
C2: 32E-6

- Click **Save** to write the coefficients to the instrument. The instrument must be connected to Ruskin.

If successful, a success message will appear.

Calculated coefficients

C0: -11.2267917E0  
C1: 791.938838E0  
C2: 32E-6

Writing to instrument...Complete  
Processing data...Complete

If not, a warning message will appear instead.

Calculated coefficients

C0: -11.2604861E0  
C1: 792.457953E0  
C2: 32E-6

Writing to instrument...  
Warning: Unable to find instrument RBRconcerto 0656:  
Writing to database...Complete  
Processing data...Complete

 Calibration coefficients are stored on the instrument and not the sensor. Recalibrate your sensor if you move it to a different instrument.

## 22.2 Turbidity sensor calibration

 Use only datasets in **Desktop** storage format to calibrate the sensors. The **Calibration** tab is not available in **Mobile** mode.

RBR standard instruments support turbidity sensors from third-party manufacturers. User calibration is available for Seapoint® and Turner® sensors.

RBR factory-calibrates the turbidity sensors using the **N**-point method, with **N** = 7. For user calibration, we recommend using the two-point method (**N** = 2) under fluorescent lighting, which will include a **zero reference point** and a **non-zero reference point**.

Alternatively, you can perform a one-point calibration using a single **zero reference point** in distilled water. Calibration will only correct the coefficients for an offset.

 When performing the one-point method, use only a zero reference point. With a single **non-zero reference point**, calibration will recompute the slope coefficient. Go this route only if you are confident in your non-zero standard.

### 22.2.1 Tu data collection

Follow the steps below to obtain the calibration dataset for your Tu sensor.

#### Equipment and materials

- A wide-mouth, black-walled container (large enough to hold the instrument)
- Secure black lid for the container with an orifice for the instrument
- Small black lid or any light-blocking material to cover the orifice during calibration
- 400FTU Formazin standard
- Distilled water
- Large magnetic stirrer
- Rubbing alcohol
- Soft cloth

#### Ruskin configuration

1. Go to **Configuration**.
2. Use **Local** on Ruskin to synchronise the instrument clock with your computer.
3. Set the sampling rate to 1s (1Hz).
4. Under **Ranging sensors**, set **Range** to **Auto**.
5. Enable your schedule.

 The instrument must be logging throughout the calibration procedure.

### Sensor preparation

1. Wash the sensor and container with distilled water and dry them with a soft cloth.
2. Check the turbidity window for stains and scratches.

**⚠** Do not proceed with calibration if there are serious scratches.

3. Wipe the turbidity window with alcohol to remove all stains.

### Zero reference point

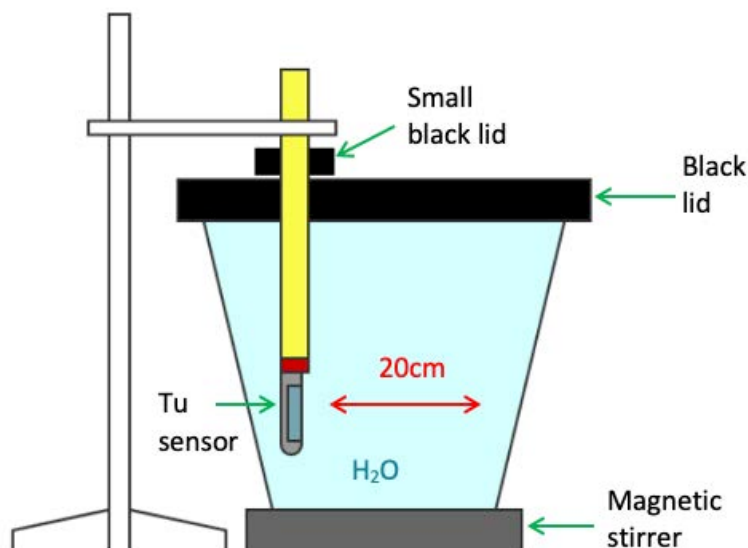

1. Fill the black-walled container with distilled water.
2. Turn on the magnetic stirrer and adjust the RPM to ensure no vortex appears.
3. Place the black lid on the container and avoid direct light on the container.
4. Submerge the sensor through the orifice in the lid, vertically along the wall, with the turbidity window facing the larger water volume.

**⚠** The distance from the turbidity window to the container wall must be at least 20cm.

5. Cover the orifice with the smaller black lid or light-blocking material, like a thick plastic bag.
6. Record the data in distilled water for at least 15min, up to an hour.  
This is the zero-turbidity calibration point.

### Non-zero reference point

Repeat the steps for the **zero reference point**, replacing distilled water with 400FTU Formazin standard.

This is the 400NTU calibration point.

As each reference point takes 15 minutes to an hour, the entire procedure may take up to two hours.

After completing the procedure for both reference points (or for a single reference point, if using the one-point method), proceed to calibration on Ruskin.

## 22.2.2 Tu calibration in Analysis tab

For turbidity calibration, we recommend using the two-point method, which includes a **zero reference point** and a **non-zero reference point**.

Alternatively, you can perform a one-point calibration using a single **zero reference point**.

### Two-point calibration steps on Ruskin

1. Stop the deployment.
2. Download the dataset.
3. Open the dataset on Ruskin. The **Properties** windows will change to dataset properties, with the **Analysis** tab displayed.

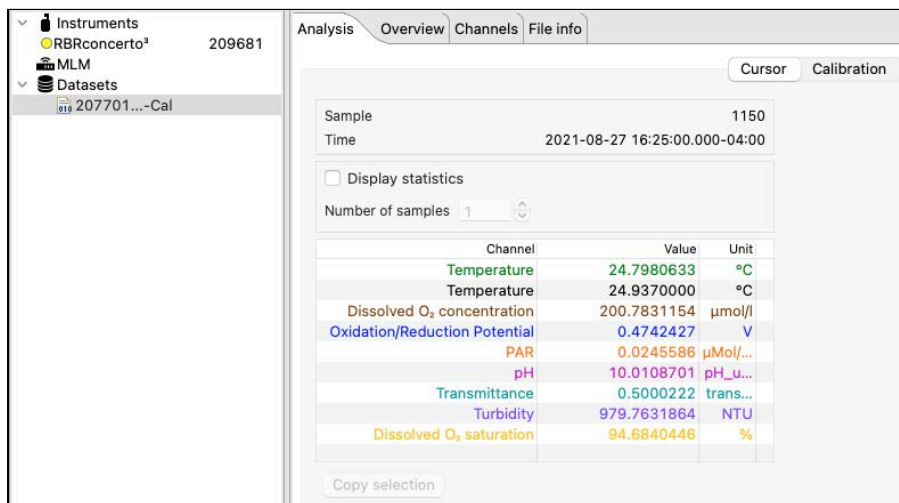

4. Click **Calibration**.
5. Select **Turbidity** from the dropdown list.  
By default, the **Number of samples** is set to **100**, which means Ruskin will average the calibration coefficients over a hundred sample points. Typically, this value should be in the range from 50 to 100 samples. The **Raw channel** box is unchecked, and thus the true turbidity values will be displayed in the plot below. To see the raw voltage values, check this box.

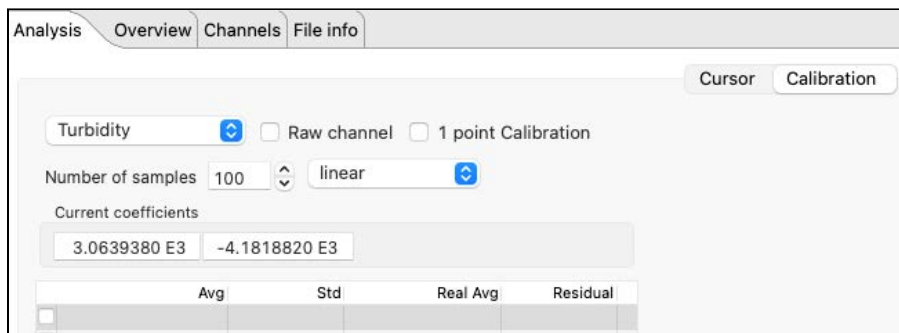

A downsampled representation of the dataset will appear in the thumbnail view, with two distinct plateaus corresponding to zero NTU and 400NTU. Irregular readings in-between mark the times when you changed from water to formazin and reassembled the setup.



6. Check the box next to the first row in the calibration table.
7. Click on a stable point in the **Plot** view corresponding to zero NTU.

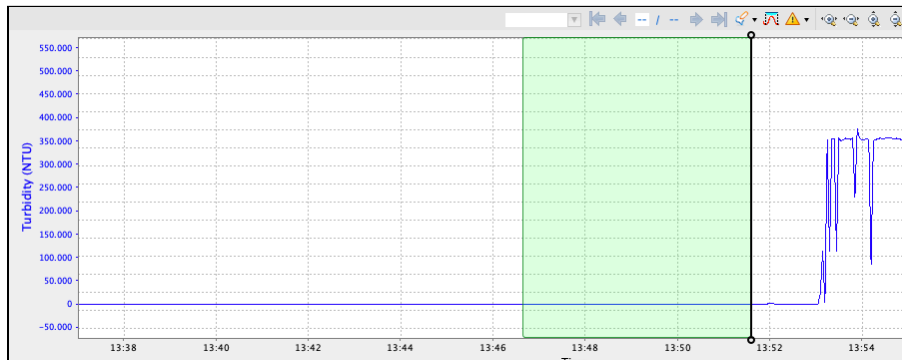

The interval of 100 samples will be highlighted. The average value (**Avg**) and standard error (**Std**) for this interval will appear in the table above.

8. Under **Real Avg** in the first row, enter **0** and press enter.

Analysis Overview Channels File info

Cursor Calibration

Turbidity  Raw channel  1 point Calibration

Number of samples 100 linear

Current coefficients

3.0639380 E3 -4.1818820 E3

	Avg	Std	Real Avg	Residual
<input checked="" type="checkbox"/>	0.005194	0.0091773	0.000000	

9. Repeat the same steps for the second plateau, entering **400** under **Real Avg**.
10. Ruskin automatically calculates the calibration coefficients, and the values appear in **Calculated coefficients**.

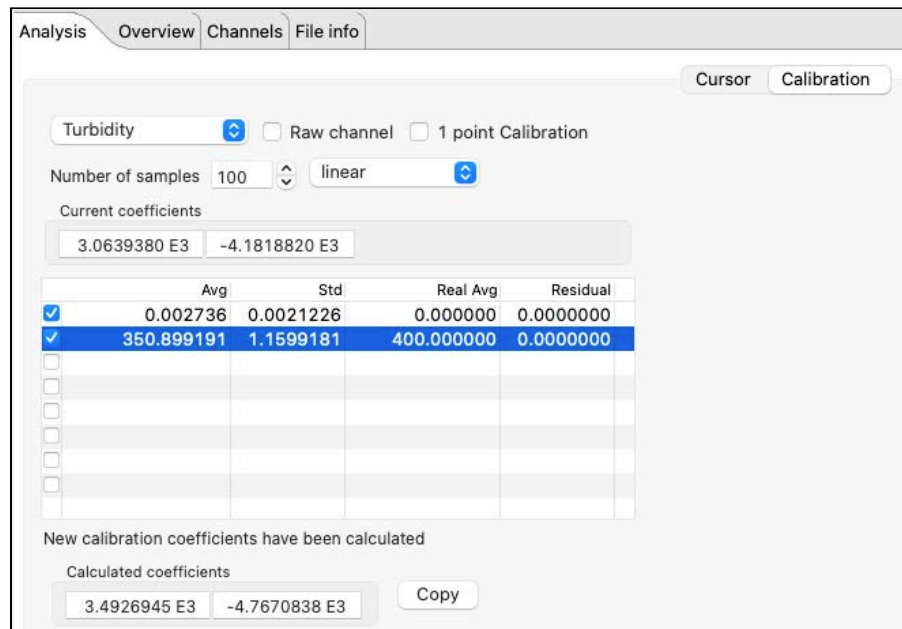

**!** When a two-point calibration is performed correctly, residuals will be 0.

11. Click **Copy** to save the new calibration coefficients to the clipboard, or write them down.
12. In the **Navigator** view, find your instrument.
13. Click **Calibration** and select **Turbidity** from the dropdown list.
14. Click **C0** to select the entry field and type in the new value (in this example, **3492.6945** ).
15. Click **C1** to select the entry field and type in the new value (in this example, **-4767.0838**).
16. Click **Store calibration** to save the new coefficients.

**!** Always click **Store calibration** to save new coefficients on the instrument. Otherwise, all changes will be lost once your session is closed.



### One-point calibration steps on Ruskin

1. Stop the deployment.
2. Download the dataset.
3. Open the dataset on Ruskin. The **Properties** windows will change to dataset properties, with the **Analysis** tab displayed.
4. Click **Calibration**.
5. Select **Turbidity** from the dropdown list.
6. Check the **1 point calibration** box.
7. Click on a stable point in the **Plot** view corresponding to zero NSU.  
The interval of 100 samples will be highlighted. The average value (**Avg**) and standard error (**Std**) for this interval will appear in the table above.
8. Click the **RealAvg** column and select **0** from the dropdown.

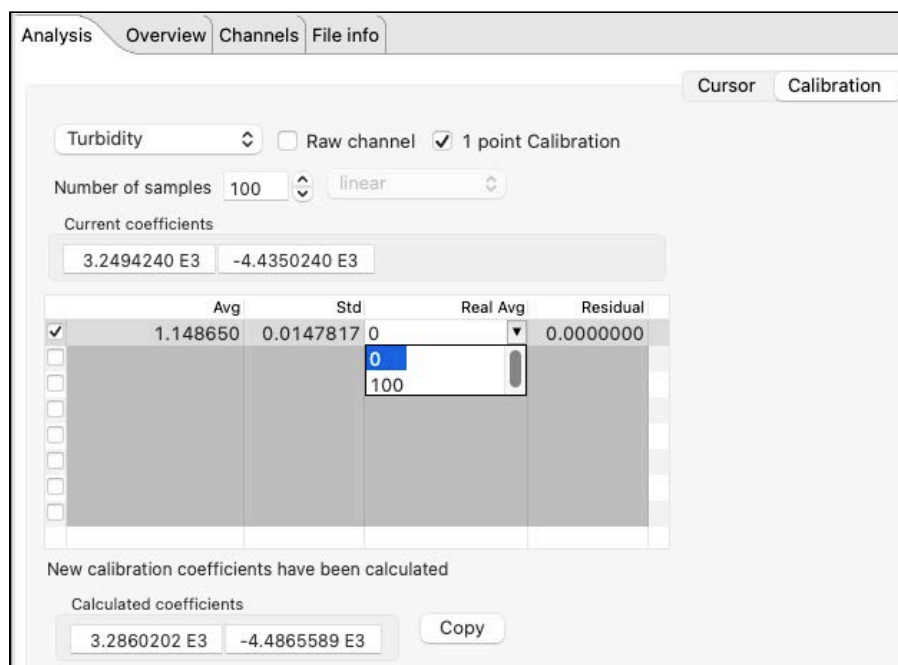

9. Click **Copy** to save the new calibration coefficients to the clipboard, or write them down.
10. In the **Navigator** view, find your instrument.
11. Click **Calibration** and select **Turbidity** from the dropdown list.
12. Click **C0** to select the entry field and type in the new value.
13. Click **C1** to select the entry field and type in the new value.
14. Click **Store calibration** to save the new coefficients.

**!** Always click **Store calibration** to save new coefficients on the instrument. Otherwise, all changes will be lost once your session is closed.

## 22.3 pH sensor calibration

 Use only datasets in **Desktop** storage format to calibrate the sensors. The **Calibration** tab is not available in **Mobile** mode.

RBR standard instruments support the Idronaut® pH sensors.

For pH sensors, RBR recommends user calibration using the **N**-point method, with **N** = 3. Calibrate the pH sensors before each deployment, using three buffer fluids for optimum accuracy. For best results, perform in a temperature-controlled bath at 25°C, with a marine thermistor in the bath.

 Use the three-point calibration method:

- To check the zero point, use a pH 7 buffer fluid.
- To set the slope, use an acidic and a basic buffer. RBR uses pH 4 and pH 10 buffer fluids to set the slope.

### 22.3.1 pH data collection

Follow the steps below to obtain the calibration dataset for your pH sensor.

#### Equipment and materials

- Wide-mouth beaker or any container (large enough to maintain adequate distance from the sensor face to the wall)
- Narrow-mouth beaker which can fit both the pH and reference sensors
- Submersible magnetic stirrer (optional)
- Submersible magnetic stirrer pad (optional)
- Clean tap water
- pH 4, pH 7, and pH 10 buffer fluids
- Marine thermistor (on your instrument)

#### Ruskin configuration

1. Go to **Configuration**.
2. Use **Local** on Ruskin to synchronise the instrument clock with your computer.
3. Set the sampling rate to the fastest rate possible for the instrument.
4. Enable your schedule.

 The instrument must be logging throughout the calibration procedure.

### Temperature bath preparation

1. Fill the larger beaker with warm tap water (at 25°C).
2. Submerge the marine thermistor in the bath.
3. Optionally, place the magnetic stirrer at the bottom. Use the submersible magnetic stirrer pad to adjust the stirrer height.

### Buffer bath procedure

**⚠** The buffer bath steps are repeated three times, each time with a new buffer fluid: **pH 4**, **pH 7**, and **pH 10**. Buffer fluids are colour-coded, so it is easy to keep track of the steps.

1. Fill the smaller beaker with pH 4 buffer fluid.
2. Rinse both the pH sensor and reference sensors with clean water, then with pH 4.
3. Warm up the beaker in your hand or in warm water.
4. Submerge both the pH and reference sensors in the same pH 4 buffer solution.  
If using the magnetic stirrer, position your sensors near it, as that is in the best-mixed area of the bath.
5. Stir for 30 minutes or until the pH and temperature signals have stabilised.

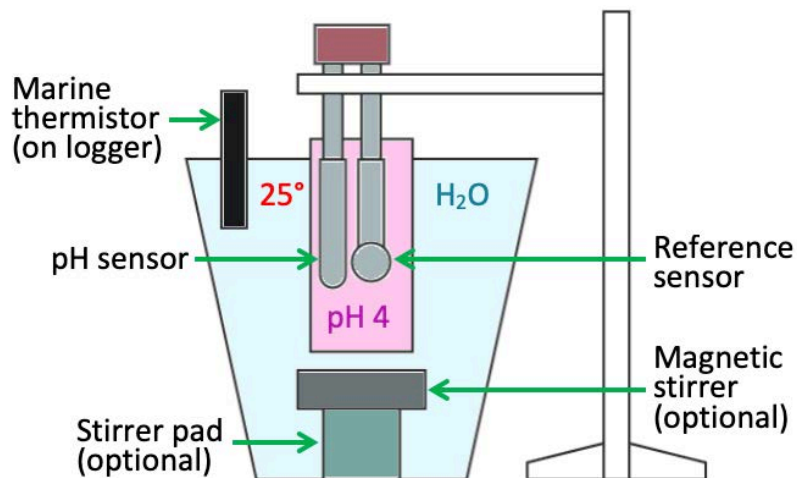

Repeat with pH 7.

Repeat with pH 10.

As each buffer fluid procedure takes at least 30 minutes, the entire procedure takes about two hours.

After collecting the measurements for each buffer fluid, proceed to calibration on Ruskin.

## 22.3.2 pH calibration in Analysis tab

For pH calibration, we recommend using the three-point method. The dataset will have three distinct plateaus.

### Calibration steps on Ruskin

1. Stop the deployment.
2. Download the dataset.
3. Open the dataset on Ruskin. The **Properties** windows will change to dataset properties, with the **Analysis** tab displayed.

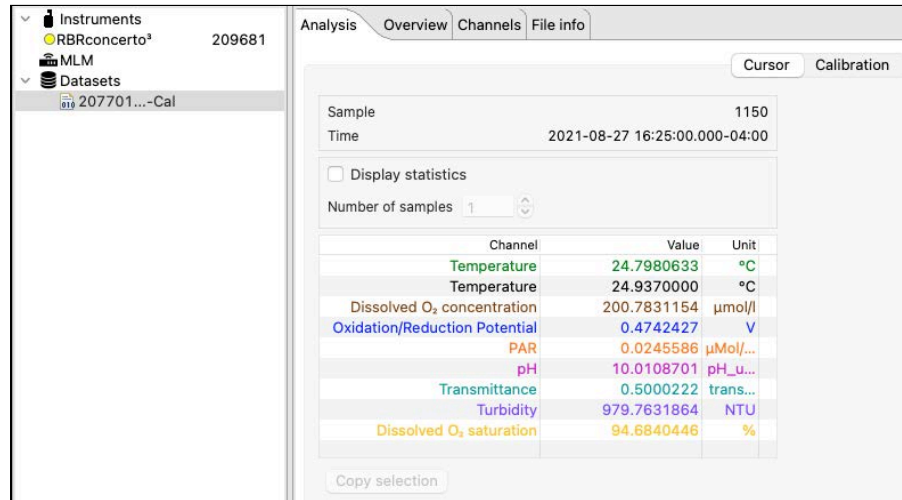

4. Click **Calibration**.
5. Select **pH** from the dropdown list.  
By default, the **Number of samples** is set to **100**, which means Ruskin will average the data points for the calibration over a hundred sample points.  
Use the up and down arrows to adjust this value. Typically, it should be in the range from 20 to 100 samples, depending on the sampling rate. For 16Hz, select **100**. For 2Hz, select **20**.  
The **Raw channel** box is unchecked, and thus the true pH values will be displayed in the plot below. To see the raw voltage values, check this box.

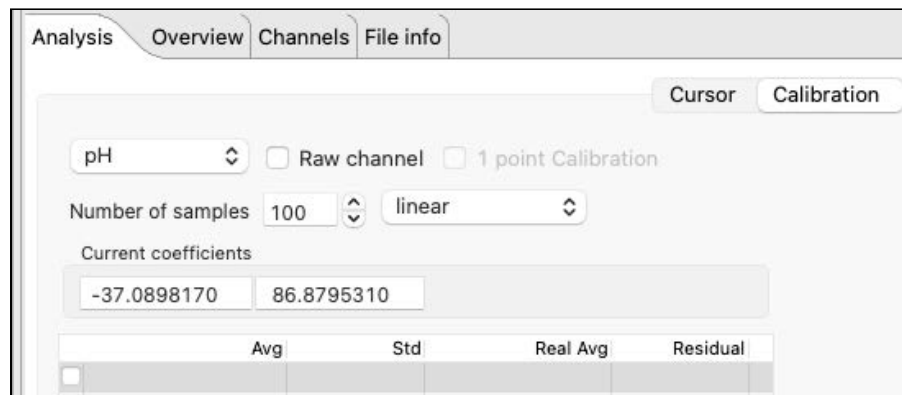

A downsampled representation of the dataset will appear in the thumbnail view, with three distinct plateaus corresponding to pH 4, pH 7, and pH 10. Irregular readings in-between mark the times when you changed the buffer fluid and reassembled the setup.



6. Check the box next to the first row in the calibration table.
7. Inspect the plateau for possible trends and irregularities.
8. Click on a stable point in the **Plot** view corresponding to pH 4. Ensure the selected region is stable (within 0.005pH).

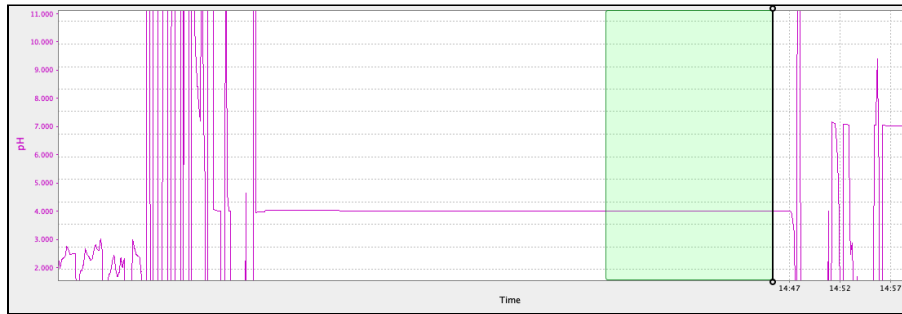

The interval of samples will be highlighted. The average value (**Avg**) and standard error (**Std**) for this interval will appear in the table above the plot.

9. Under **Real Avg** in the first row, enter **4** and press enter.

Analysis Overview Channels File info

Cursor Calibration

pH  Raw channel  1 point Calibration

Number of samples 100  linear

Current coefficients

-37.0898170 86.8795310

	Avg	Std	Real Avg	Residual
<input checked="" type="checkbox"/>	4.002556	0.0006078	4.000000	
<input type="checkbox"/>				

10. Repeat the same steps for the second plateau, entering **7** under **Real Avg.**
11. Repeat the same steps for the third plateau, entering **10** under **Real Avg.**
12. Ruskin automatically calculates the calibration coefficients, and the values appear in **Calculated coefficients.**

Analysis Overview Channels File info

Cursor Calibration

pH  Raw channel  1 point Calibration

Number of samples 100 linear

Current coefficients

-37.0898170 86.8795310

	Avg	Std	Real Avg	Residual
<input checked="" type="checkbox"/>	4.002556	0.0006078	4.000000	0.0048407
<input checked="" type="checkbox"/>	6.990347	0.0015574	7.000000	-0.0096349
<input checked="" type="checkbox"/>	10.009163	0.0006908	10.000000	0.0047943
<input type="checkbox"/>				
<input type="checkbox"/>				
<input type="checkbox"/>				
<input type="checkbox"/>				

New calibration coefficients have been calculated

Calculated coefficients

-37.0902940 86.8804900 Copy

13. Click **Copy** to save the new calibration coefficients to the clipboard, or write them down.
14. In the **Navigator** view, find your instrument.
15. Click **Calibration** and select **pH** from the dropdown list.
16. Click **C0** to select the entry field and type in the new value (in this example, **-37.0902940**).
17. Click **C1** to select the entry field and type in the new value (in this example, **86.8804900**).
18. Click **Store calibration** to save the new coefficients.

**⚠** Always click **Store calibration** to save new coefficients on the instrument. Otherwise, all changes will be lost once your session is closed.

## 22.4 Fluorometer calibration

 Use only datasets in **Desktop** storage format to calibrate the sensors. The **Calibration** tab is not available in **Mobile** mode.

RBR standard instruments support third-party fluorescence sensors. Fluorometers are factory-calibrated using the **N**-point calibration method; typically, with **N** = 3. User calibration is available only for fluorescence sensors manufactured by Turner®.

You can perform a one-point calibration (**N** = 1) and establish a new **zero reference point** to account for drift or damage to the face of the sensor (offset correction). If the readings are too far from the expected value, contact [RBR](#) for help. You may have to return the instrument to RBR for a full calibration.

Alternatively, you can perform a two-point calibration (**N** = 2), which includes a **zero reference point** and a **non-zero reference point**. This method can help you align a new fluorometer with your previous research standards.

### 22.4.1 Fluorescence data collection

Follow the steps below to obtain the calibration dataset for your fluorometer.

#### Equipment and materials

- A wide-mouth, black-walled container (large enough to maintain adequate distance from the sensor face to the wall)
- Black lid for the container
- Distilled water
- Rubbing alcohol
- Soft cloth

#### Ruskin configuration

1. Go to [Configuration](#).
2. Use **Local** on Ruskin to synchronise the instrument clock with your computer.
3. Set the sampling rate to the fastest rate possible for the instrument.
4. Under **Ranging sensors**, set **Range** to **Auto**.
5. Enable your schedule.

 The instrument must be logging throughout the calibration procedure.

### Sensor preparation

1. Wash the sensor and container with distilled water and dry them with a soft cloth.
2. Check the sensor window for discolouration and scratches.

⚠ Do not proceed with calibration if there are serious scratches.

3. Wipe the sensor window with alcohol.

### Zero reference point

1. Fill the black-walled container with distilled water.
2. Fully submerge the sensor.

⚠ The distance from the sensor window to the container wall must be at least 20 cm.

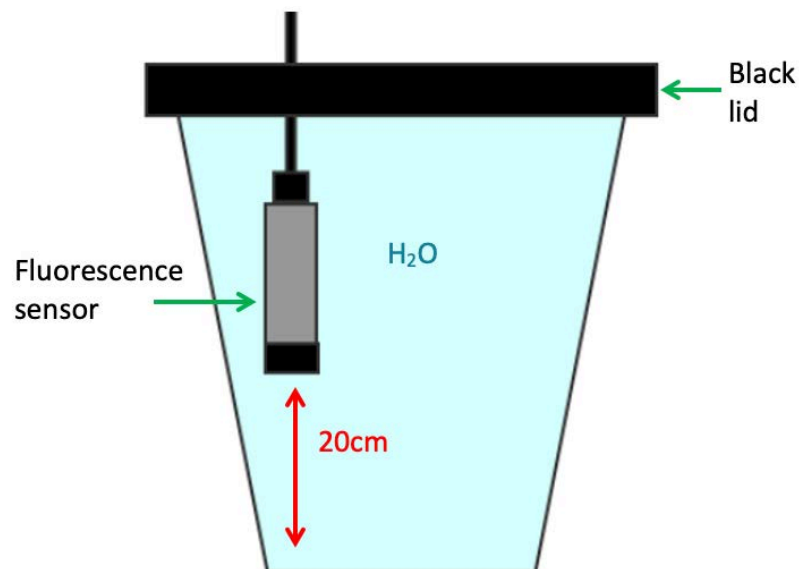

3. Record the data for five minutes.  
This is the zero calibration point.

### Non-zero reference point

To perform a two-point calibration, you will need your own standard non-zero point obtained using reference fluorescence solutions such as rhodamine dye or fluorescein, or environmental samples with known chlorophyll concentration.

Collect these data in a setting of your choosing.



## 22.4.2 Chlorophyll a calibration in Analysis tab

Use a one-point method to calibrate your fluorometer for offset correction, establishing a new **zero reference point**.

Alternatively, you can perform a two-point calibration, which includes a **zero reference point** and a **non-zero reference point**. This method can help you align a new fluorometer with your previous research standards.

### One-point calibration steps on Ruskin

1. Stop the deployment.
2. Download the dataset.
3. Open the dataset on Ruskin. The **Properties** windows will change to dataset properties, with the **Analysis** tab displayed.

Channel	Value	Unit
Conductivity	-0.0042477	mS/cm
Temperature	21.6679790	°C
Pressure	10.0132230	dbar
Chlorophyll a	0.0602301	µg/l
Turbidity	2.0358453	NTU
PAR	2.6196365	µMol/...
Sea pressure	-0.1192780	dbar
Depth	-0.1185451	m
Salinity	0.0110111	PSU
Speed of sound	1487.3766266	m/s
Specific conductivity	-4.5359090	µS/cm
Density anomaly	-	kg/m³

4. Click **Calibration**.
5. Select **Chlorophyll a** from the dropdown list.  
By default, the **Number of samples** is set to **100**, which means Ruskin will average the calibration coefficients over a hundred sample points.  
Use the up and down arrows to adjust this value. Typically, it should be in the range from 20 to 100 samples, depending on the sampling rate. For 16Hz, select **100**. For 2Hz, select **20**.  
The **Raw channel** box is unchecked, and thus the true chlorophyll *a* values will be displayed in the plot below. To see the raw voltage values, check this box.

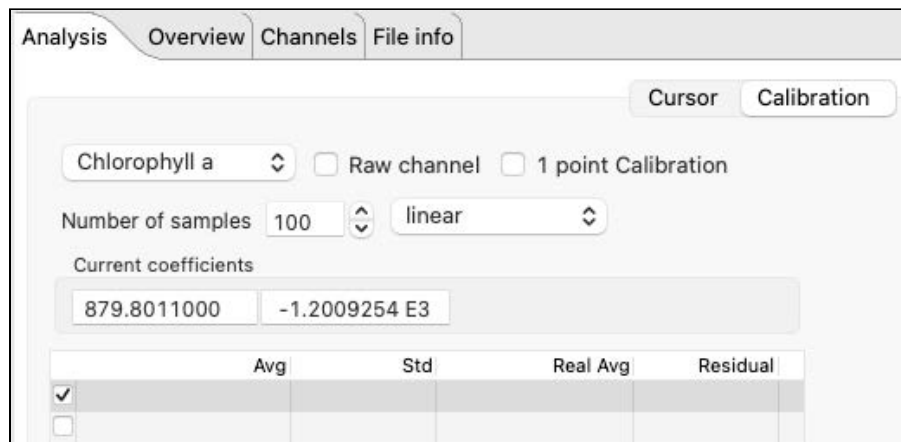

A downsampled representation of the dataset will appear in the thumbnail view, with a plateau at 0 $\mu$ g/L.



6. Check the **1 point calibration** box.
7. Click on a stable point in the **Plot** view corresponding to 0 $\mu$ g/L.  
The interval of 100 samples will be highlighted. The average value (**Avg**) and standard error (**Std**) for this interval will appear in the table above.
8. Click the **RealAvg** column and select **0** from the dropdown.

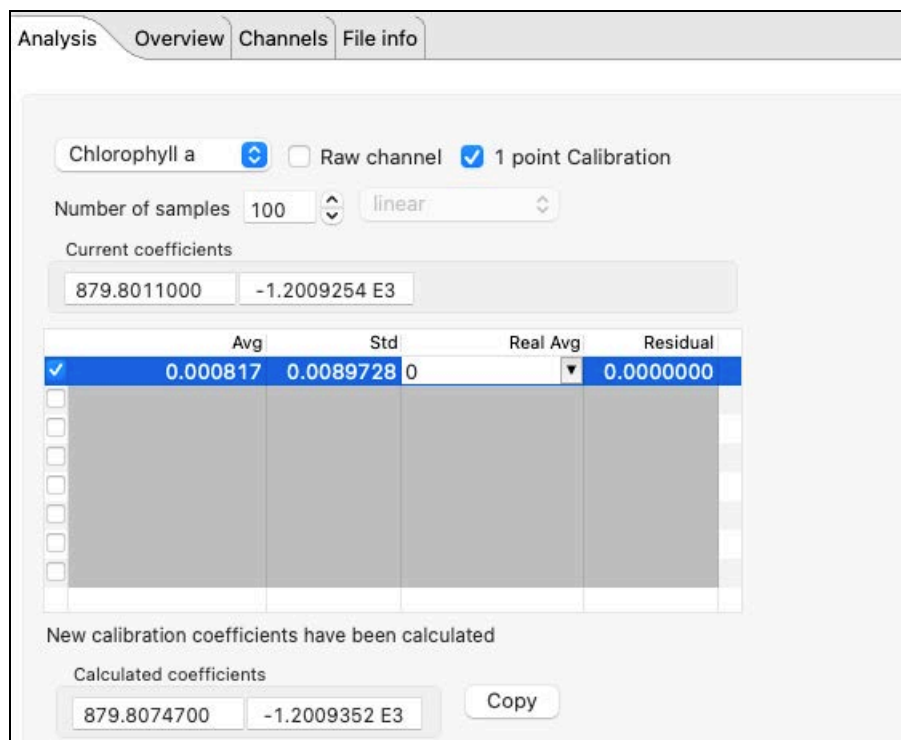

The new calibration coefficients will be displayed under the table.

10. Click **Copy** to save the new calibration coefficients to the clipboard, or write them down.
11. In the **Navigator** view, find your instrument.
12. Click **Calibration** and select **Chlorophyll a** from the dropdown list.
13. Click **C0** to select the entry field and type in the new value.
14. Click **C1** to select the entry field and type in the new value.
15. Click **Store calibration** to save the new coefficients.

**⚠** Always click **Store calibration** to save new coefficients on the instrument. Otherwise, all changes will be lost once your session is closed.

### Two-point calibration steps on Ruskin

1. Stop the deployment.
2. Download the dataset.
3. Open the dataset on Ruskin. The **Properties** windows will change to dataset properties, with the **Analysis** tab displayed.
4. Click **Calibration**.
5. Select **Chlorophyll a** from the dropdown list.  
By default, the **Number of samples** is set to **100**, which means Ruskin will average the calibration coefficients over a hundred sample points.
6. Use the up and down arrows to adjust this value. Typically, it should be in the range from 20 to 100 samples, depending on the sampling rate. For 16Hz, select **100**. For 2Hz, select **20**.  
The **Raw channel** box is unchecked, and thus the true chlorophyll a values will be displayed in the plot below. To see the raw voltage values, check this box.  
A downsampled representation of the dataset will appear in the thumbnail view, with two distinct plateaus corresponding to 0 and 100µg/L.

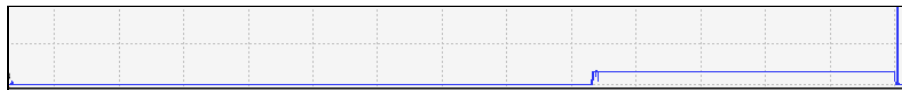

7. Check the box next to the first row in the calibration table.
8. Click on a stable point in the **Plot** view corresponding to 0µg/L.



The interval of samples will be highlighted. The average value (**Avg**) and standard error (**Std**) for this interval will appear in the table above.

- Under **Real Avg** in the first row, enter **0** and press enter.

Analysis Overview Channels File info

Chlorophyll a  Raw channel  1 point Calibration

Number of samples 20 linear

Current coefficients

586.6349000 -800.7089000

	Avg	Std	Real Avg	Residual
<input checked="" type="checkbox"/>	0.000271	0.0045773	0.000000	
<input type="checkbox"/>				

Repeat the same steps for the second plateau, entering **100** under **Real Avg**.

- Ruskin automatically calculates the calibration coefficients, and the values appear in **Calculated coefficients**.

Analysis Overview Channels File info

Chlorophyll a  Raw channel  1 point Calibration

Number of samples 20 linear

Current coefficients

586.6349000 -800.7089000

	Avg	Std	Real Avg	Residual
<input checked="" type="checkbox"/>	0.000020	0.0056108	0.000000	0.0000000
<input checked="" type="checkbox"/>	105.252983	0.0524749	100.000000	0.0000000
<input type="checkbox"/>				
<input type="checkbox"/>				
<input type="checkbox"/>				
<input type="checkbox"/>				

New calibration coefficients have been calculated

Calculated coefficients

557.3571200 -760.7471400

When a two-point calibration is performed correctly, residuals will be 0.

- Click **Copy** to save the new calibration coefficients to the clipboard, or write them down.
- In the **Navigator** view, find your instrument.
- Click **Calibration** and select **Chlorophyll a** from the dropdown list.
- Click **C0** to select the entry field and type in the new value (in this example, **557.35712**).
- Click **C1** to select the entry field and type in the new value (in this example, **-760.74714**).
- Click **Store calibration** to save the new coefficients.

Always click **Store calibration** to save new coefficients on the instrument. Otherwise, all changes will be lost once your session is closed.

## 23 Revision history

Revision No.	Release Date	Notes
1.0 - H	2011-2020	Various
J	31-August-2022	Restructured the user guide to reflect Ruskin interface, added a dedicated page for RSK files, edited existing instructions for clarity, removed outdated sections and screenshots.
K	31-December-2022	Added a section on the Search option under Support (for Mac users). Updated the RSK files and File info sections to reflect new file structure labels. Added a note in the Gating section. Enhanced Plot window instructions. Updated the Power section. Corrected typos in the User calibration section.
L	31-March-2023	Added/updated screenshots in several sections (Ruskin interface, Simulate an instrument, Configuration, and Appearance controls) for clarity. Added information on synchronising the instrument clock in the Schedule section. Added the Connections page. Corrected a typo in the Tide section. Updated the Analysis, Annotation controls, Zoom controls, and Automated tasks sections. Added the Utilities page.

