

RBR *quartz*³ Q | plus INSTRUMENT GUIDE



rbr-global.com

Table of contents

1	RBR <i>quartz</i> ³ Q plus	3
2	Specifications	4
3	Hardware	6
3.1	Opening and closing the instrument	6
3.2	RBR <i>quartz</i> ³ Q plus interface	8
3.3	Orientation and datum location	9
4	General maintenance	10
4.1	Support kit.....	10
4.2	Replacing the O-ring	11
4.3	Replacing the batteries.....	12
4.4	Replacing the desiccant capsules	13
4.5	Cables and connectors	15
4.6	Cleaning the instrument.....	16
4.7	Calibrating the instrument	16
5	Pressure sensor maintenance	17
5.1	Removing the antifouling mesh assembly.....	17
5.2	Filling the syringe and de-gassing the buffer oil.....	18
5.3	Cleaning the buffer tube	19
5.4	Refilling the buffer oil.....	20
6	External pressure adaptor	23
7	Repairs	24
8	Revision history	24

1 RBR*quartz*³ Q | plus

The RBR*quartz*³ Q | plus tide and wave logger integrates the Paroscientific Digiquartz® pressure sensor for best-in-class initial accuracy and low drift performance.

Intended for long-term autonomous or realtime observations of water level, tides, and waves, the RBR*quartz*³ Q | plus has high stability and can resolve small changes over long deployments. Flexible measurement schedules, burst sampling, and configurable integration times allow for a broad range of applications in coastal dynamics. The RBR*quartz*³ Q | plus offers USB and RS-232/RS-485 connectivity.

For a detailed description of wave and tide measurements, see [Ruskin User Guide: Standard Loggers³](#).



RBR*quartz*³ Q | plus

2 Specifications

Instrument

Parameter	Value
Storage	240 million readings
Power	24 D-type cells
External power	4.5V to 30V
Communications	Internal: USB-C; external: USB and RS-232/485
Clock drift	±60 seconds/year
Depth rating	260m
Housing material	Plastic
Dimensions	~562.5mm x Ø140mm
Weight (with batteries)	11.7kg in air, 2.8kg in water

Temperature

Parameter	Value
Range	-5°C to 35°C
Initial accuracy	±0.002°C
Resolution	0.00005°C
Typical stability	±0.002°C/year
Time constant	<2min (embedded)

Pressure

Parameter	Value
Range	20/55/125/190/260dbar
Initial accuracy	±0.01% full scale
Resolution	100ppb (at 1Hz sampling rate)

Power supply selection

If connected, an external power supply will be used preferentially over the internal batteries as long as the voltage remains 4.5V or greater. If it drops below 4.5V or complete disconnection occurs, the system automatically switches to the internal batteries.

Clock

The instrument's clock is maintained during brief disconnections. This time is usually sufficient to change batteries or replace desiccants.

USB-C power

The USB-C cable provides power sufficient for configuration or data download. However, the instrument requires an internal or external power supply to perform sampling.

Deployment estimates (with lithium thionyl chloride cells)

Speed	Burst samples	Interval	Time	# of samples
16Hz	-	Continuous	64 days	88 million
4Hz	4096	120min	4.9 years	88 million
1s	-	Continuous	2.8 years	88 million
1s	512	30min	5.3 years	88 million
1s	512	60min	10+ years	88 million

External MCBH-6-MP connector pinout

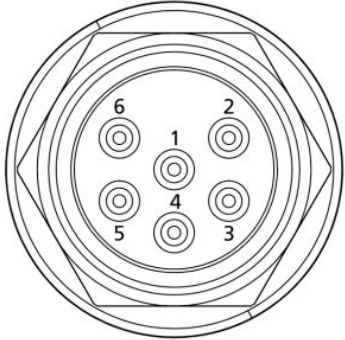
	Pin No.	USB	RS-232	RS-485
	1	Ground		
2	Power +4.5 to +30V			
3	N/C		From the instrument (Tx)	From the instrument (Tx-)
4	+5V		Into the instrument (Rx)	Into the instrument (Rx+)
5	D-		N/C	Into the instrument (Rx-)
6	D+		N/C	From the instrument (Tx+)

3 Hardware

3.1 Opening and closing the instrument

Opening the instrument

1. Locate two release tabs on the opposite sides of the battery end-cap.

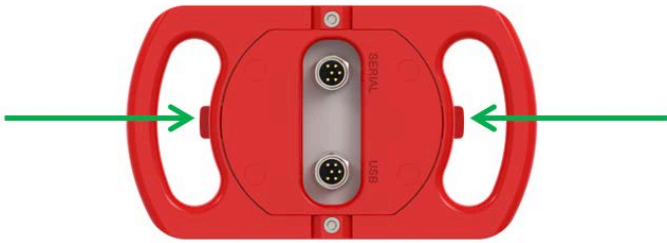

2. Push at the tabs from the top to release the end-cap handles.

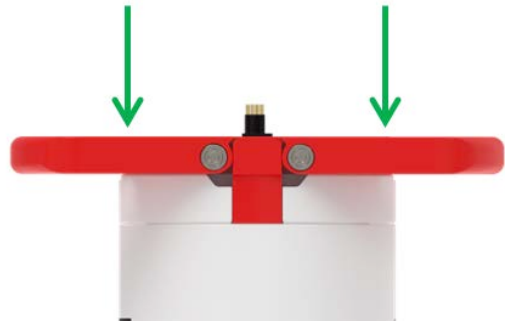

3. Move the handles up from both sides.

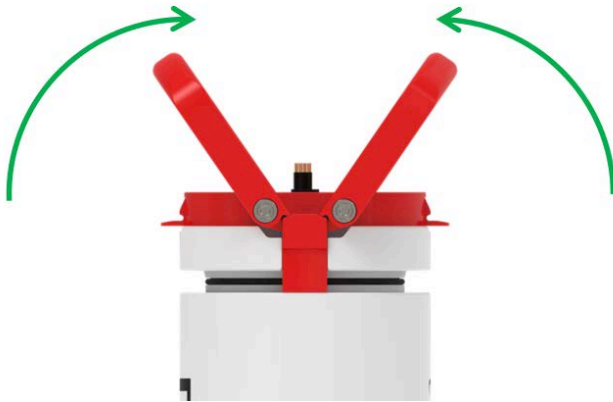

4. Firmly grip both battery end-cap handles and pull them up to remove the battery carriage.



Closing the instrument

1. Align the battery end-cap with the slots on the instrument housing and gently push down to ensure it fits in place.

 There is only one way to insert the battery end-cap. If it does not latch, rotate the battery carriage 180 degrees and try again.

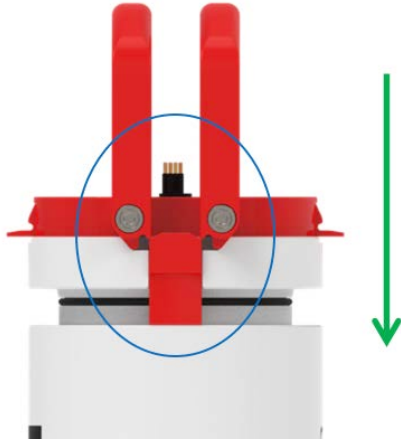

2. Place both hands on the top of the end-cap handles and gently push them out, towards the opposite sides, until they click.

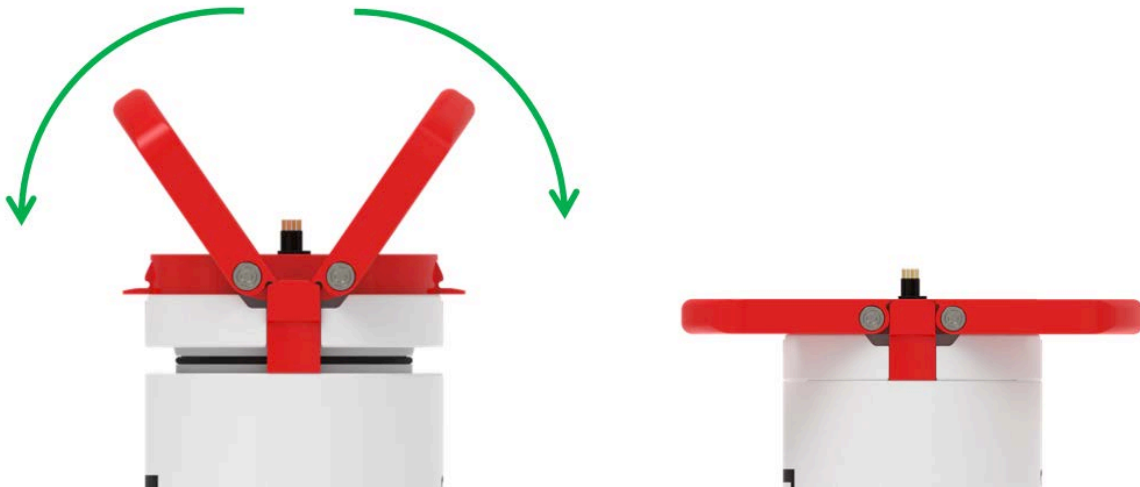

3.2 RBRquartz³ Q | plus interface

The RBRquartz³ Q | plus provides three communication ports: an internal USB-C port plus two external MCBH connectors. One external connector is for the USB communication and the other is either RS-232 or RS-485 (selected at the time of order). These external connectors provide realtime data access and supply external power.

USB-C connection

Remove the battery carriage to access the USB-C port located mid-way down the instrument body (see [Opening the instrument](#)).

A USB-C desktop cable (USB-C to USB-C) is included in the instrument [support kit](#). Use this cable to download data from the RBRquartz³ Q | plus to your computer.



RBRquartz³ Q | plus USB-C port location

MCBH connectors

For longer deployments or realtime data access, you may require patch cables and underwater extension cables. These are not included in the support kit and connect to your instrument via the MCBH ports located on the battery end-cap. The MCBH ports allow data downloads to occur in less than ideal conditions without jeopardising the watertight seal.

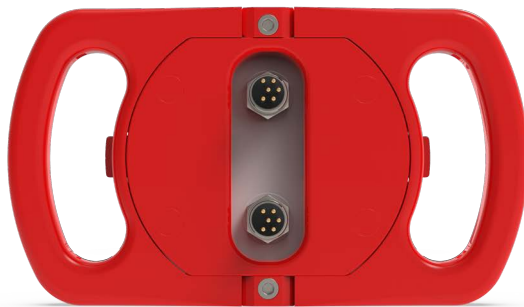

RBRquartz³ Q | plus MCBH port location

 Patch cables and underwater extension cables are sold separately.

3.3 Orientation and datum location

Vertical deployment (recommended)

RBR performs an offset adjustment with the sensors facing downwards, as shown in the first image. It is recommended to deploy the instrument vertically to match the way it was calibrated.

When deployed vertically, the datum for the pressure measurements for the RBR*quartz*³ Q | plus is located at the centre of the pressure sensor port, at the lowest surface of the instrument.

⚠ Avoid deploying the instrument vertically with the sensor end-cap up! Such orientation will affect performance of the pressure sensor due to increased build-up of sediment.



**Recommended orientation:
sensor end-cap down**

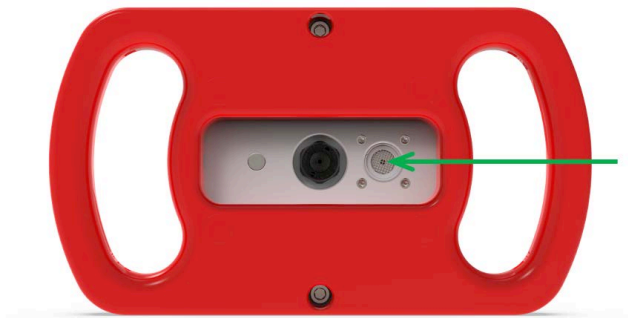

Datum location

Horizontal deployment

It is acceptable to deploy the RBR*quartz*³ Q | plus horizontally if necessary. Note that, with the instrument on its side, there will be a significant change to the datum due to the internal head values. Assess the correct offset to your preferred datum point before deployment.

4 General maintenance

4.1 Support kit

RBR provides one support kit per every three instruments ordered. If you need more units, contact [RBR](#).

The RBR support kit contains an assortment of basic accessories and spare parts, as presented below.

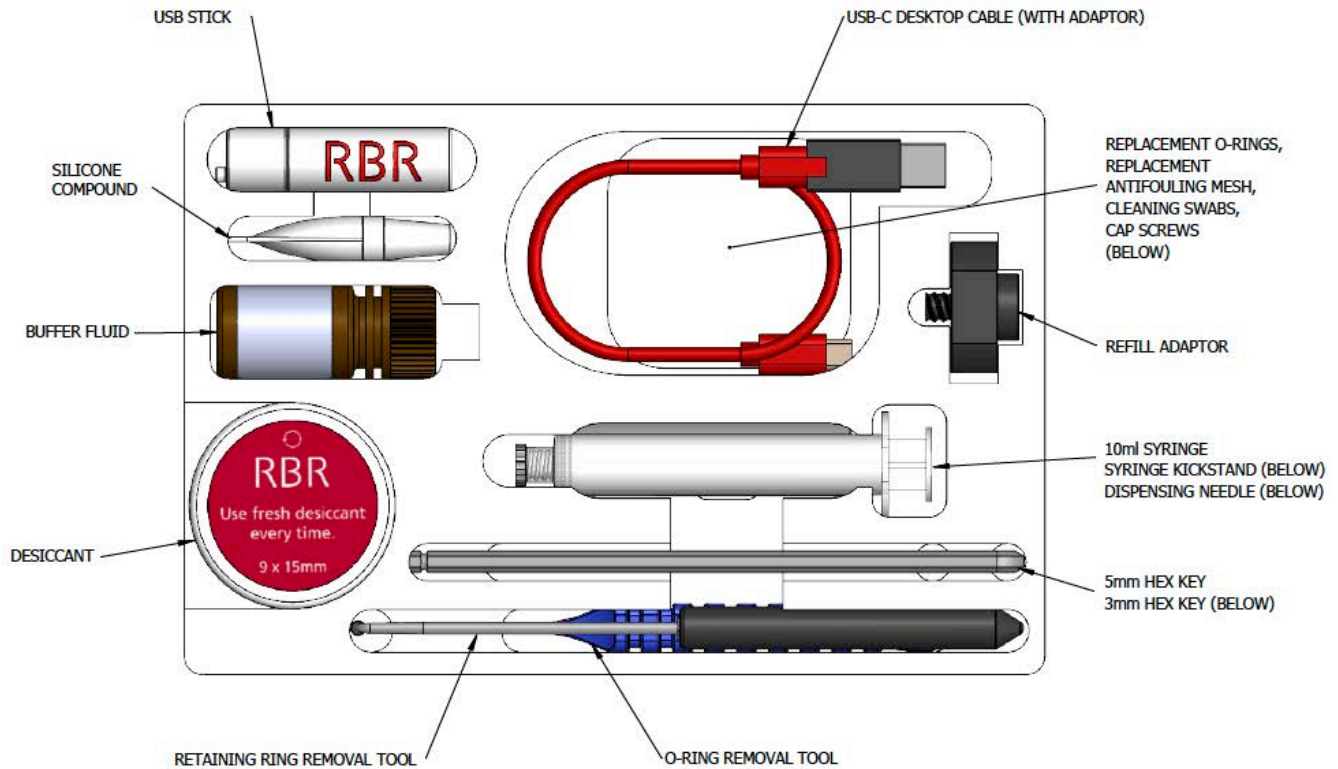

RBR Quartz³ support kit diagram

Every shipment of the RBR Quartz³ Q | plus includes a special foam stand, with a cutout for the MCBH ports.



RBR Quartz³ Q | plus foam stand



RBR Quartz³ Q | plus placed into the foam stand

4.2 Replacing the O-ring

Care for the O-ring is the single most important item of maintenance on any submersible RBR instrument. A water leak can damage the circuit board beyond repair and cause complete data loss. Every instrument seal depends upon its O-ring, not the end-cap tightness. Therefore, proper O-ring maintenance is crucial.

i The O-ring may lose elasticity over time, even when the instrument is not deployed. RBR strongly recommends replacing the O-ring regularly.

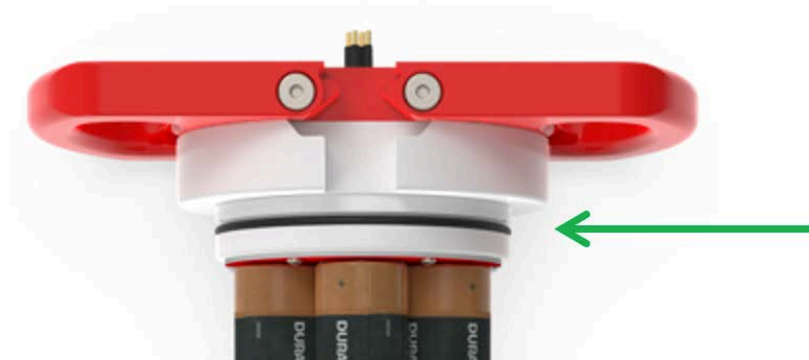

Location of the O-ring

To access the O-ring, [open the instrument](#).

Inspecting the O-ring

Visually inspect the new O-ring for nicks and scratches before installing it. Pay attention to the following areas:

- The surface of the O-ring itself
- The mating surface on the inside of the case between the threads and the open end
- The groove in the end-cap where the O-ring sits

⚠ Avoid using any object that could scratch the O-ring or any of its mating surfaces. If dirt is present in the O-ring groove, remove the O-ring as described below and thoroughly clean the groove. Do not return this old O-ring to the instrument! If you remove the O-ring from the instrument for any reason, always replace it with a new one. If the surfaces of the O-ring groove are scratched, pitted, or damaged, contact [RBR](#) for advice.

Replacing the O-ring

⚠ Do not use metal screwdrivers or any other metal tool! They may scratch the O-ring groove and render the end-cap useless.

1. Use the plastic O-ring tool (included in the [support kit](#)) to remove the O-ring from its groove. The O-ring may need to stretch quite a bit as it is pushed off. This requires some effort, but can be done by hand.
2. Clean the groove thoroughly with a soft, lint-free cloth and compressed air, if necessary.
3. Select the proper O-ring and inspect it for damage.
4. Lubricate the new O-ring with a very light film of silicone compound (included in the [support kit](#)).
5. Install the new O-ring by pushing it into place and popping it into its groove.
6. Once the new O-ring is in place, inspect it once more for scratches and debris, and wipe away any silicone compound deposited on the end-cap.
7. Once the inspection is complete, [close the instrument](#).

4.3 Replacing the batteries

RBR ships new instruments with lithium thionyl chloride batteries included. Replace batteries before each deployment to maximise the operational time and prevent data loss.

Ruskin software estimates the remaining battery life during deployment by tracking power consumption in mAh. When setting up your deployment on Ruskin, check "Fresh" to indicate that new batteries are installed.

If using the same batteries for a subsequent deployment, do not check "Fresh" and continue power tracking from the previously recorded level.

See [Ruskin User Guide: Standard Loggers³](#) for more information on predicting battery life.

To replace the batteries:

1. Remove the battery end-cap and pull out the battery carriage. See [Opening the instrument](#).
2. Remove the 24 old D-type cell batteries.
3. Insert 24 new D-type cell batteries.
4. Check for correct battery polarity.
5. Insert the battery carriage in the logger and return the end-cap back in its place. See [Closing the instrument](#).



Battery carriage with 24 D-type cell batteries

⚠ Always remove the batteries from your instrument during long-term storage! Doing so will prevent internal damage due to battery leakage and/or corrosion.

4.4 Replacing the desiccant capsules

Replace desiccant capsules before each deployment.

Fresh desiccant will keep the instrument compartment dry and prevent malfunction. Water damage may occur if condensation forms inside the instrument.

As a preventative measure, RBR recommends servicing the instrument in a cool, dry place (when possible).

Replacing desiccant capsules

1. Remove the battery end-cap. See [Opening the instrument](#).
2. Locate the desiccants holder at the bottom of the battery end-cap.
3. Remove the used desiccant capsules from their sockets.
4. Insert fresh desiccant capsules into their sockets.
5. Once all the capsules are secured, insert the battery end-cap back in its place. See [Closing the instrument](#).

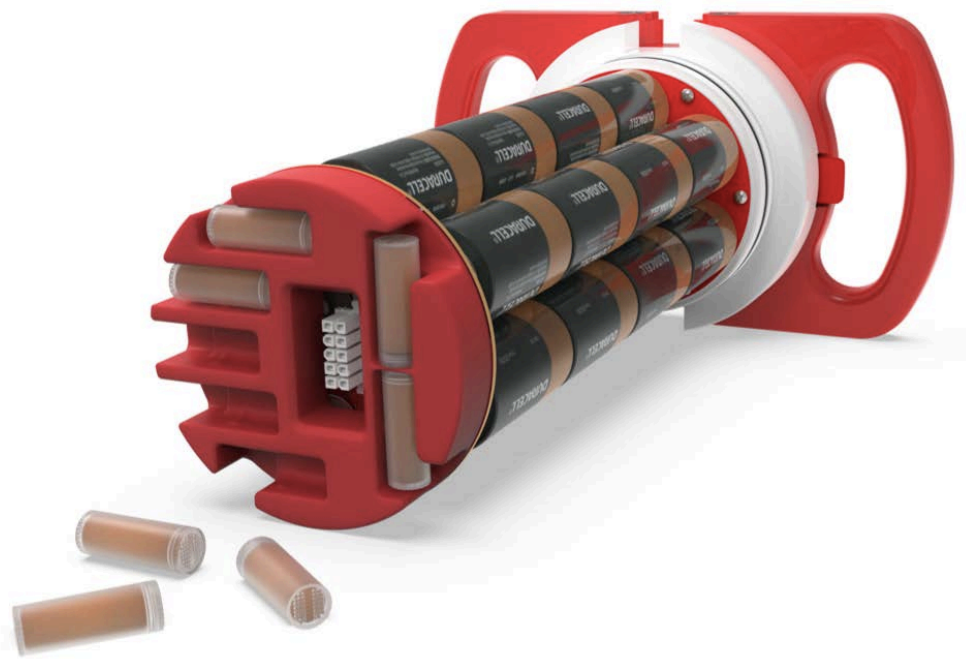

Location of the desiccant capsules

All instruments ship with fresh reusable desiccant capsules. They use a cobalt-free colour changing indicator dye. Orange indicates fresh desiccant, while green indicates it is saturated (about 15% water by weight). Once exhausted, the capsules can be replaced with new ones (available from RBR), or refreshed.



Fresh (orange) and saturated (green) desiccant capsules

Refreshing the desiccant

Follow the steps below to refresh the desiccant.

1. Remove the saturated silica beads from their capsule.
2. Place them in the oven and heat at 120°C (250°F) for about two hours.

⚠ Always remove the beads from their capsule before refreshing!
The capsule will deform if heated to 120°C.

3. Take the refreshed beads out of the oven and return them to the capsule.

⚠ Return the refreshed beads to the capsule immediately after reheating!
If left outside the capsule, the desiccant will trap moisture and go back to green.

4. Wait until the silica beads cool down. Once cool, the desiccant is ready to be reused.

4.5 Cables and connectors

Cable bend radius

The smallest bend radius for RBR supplied cables is 15cm.

Lubricating the connectors

Lubrication improves watertight sealing, prevents corrosion, and reduces the force required to de-mate the connector. Use the silicone compound provided with your instrument.

- Apply the silicone compound to all female connectors before every mating
- Ensure each connector hole is filled with approximately 30% lubricant

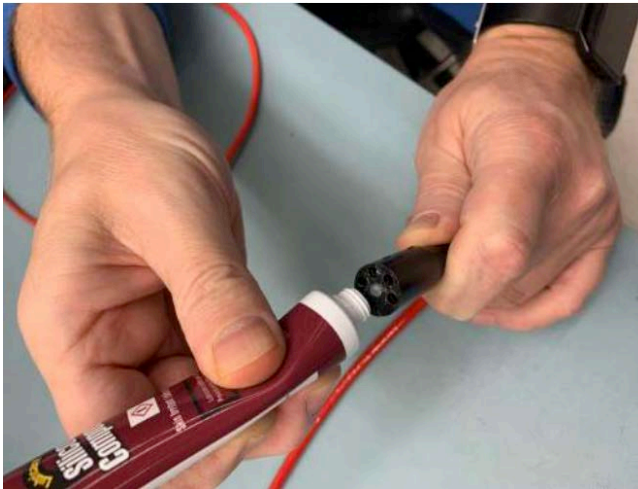

Lubricating a connector

Reducing mechanical stress

- Do not pull on the cable
- Hold onto the connector to pull out the cable
- Disconnect by pulling straight out, not at an angle
- Avoid sharp bends at the point where the cable enters the connector
- Avoid angular loads on the connector

4.6 Cleaning the instrument

Clean the instrument after each extended deployment to remove deposits that may have accumulated.

Type	Procedure	Notes
General/biofouling	To clean the exterior, soak in a mild detergent, then scrub the instrument with a soft brush.	Avoid scratching the plastic (scratches make future cleaning more difficult).
Sensor antifouling mesh	Scrub the antifouling mesh with a soft brush. Replace the antifouling mesh if needed.	See instructions on removing the antifouling mesh for more information.
Calcification	Soak in vinegar for six hours, then scrub the surface using a soft brush.	Soaking in vinegar for more than 24 hours may damage the O-ring and increase the chances of a leak.

4.7 Calibrating the instrument

Factory calibration coefficients are calculated for each sensor, and the coefficients are stored on the instrument.

RBR calibration certificates contain calibration equations, coefficients, and residuals for each sensor.

Calibration certificates are available for download:

- If using Ruskin, connect your instrument and go to the “Information” tab, then click “Download” at the bottom
- For OEM instruments, go to <https://oem-lookup.RBR-global.com>, middle tab, and search by the serial number and authorisation key

RBR recommends calibrating your instrument before any critical deployment, periodically once a year, or if you suspect the readings to be out of specifications.

Discuss your calibration requirements with RBR. In some cases, the instrument will need to be returned to RBR to have it checked and recalibrated.







Please contact [RBR](#) for our current calibration fees.

5 Pressure sensor maintenance

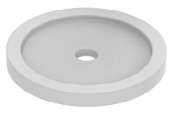
5.1 Removing the antifouling mesh assembly

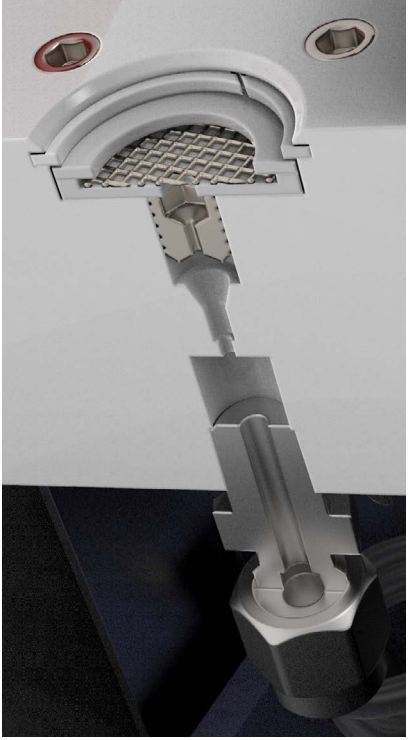
Removing the antifouling mesh assembly may be necessary for a variety of reasons, such as cleaning the instrument and its buffer tube, or installing the external pressure adaptor. Follow the steps below.

1. Remove the retaining ring using the removal tool. Hook the split in the ring at the opening and pull it out of the recess in the sensor end-cap.
2. The upper mesh insulator disk, nickel-copper mesh, and the lower mesh insulator disk will come out easily once the retaining ring is removed.

Item No.	Description	Part image	Assembled antifouling mesh	Buffer tube interface assembly
1	Lower mesh insulator disk			
2	Nickel-copper mesh			
3	Upper mesh insulator disk			
4	Retaining ring			

 Replacement parts are available in the [support kit](#).

5.2 Filling the syringe and de-gassing the buffer oil

i All required materials for this procedure are provided in the support kit.

It is important to remove all gases from the system as they can form bubbles and cause anomalies in the data. Refill the system with de-gassed oil any time when cleaning it, or if it has had an oil leak for any reason.

Required materials

- Buffer fluid
- Syringe with a stopper and needle
- Syringe kickstand

Recommended handling materials

- Latex or nitrile gloves
- Lint-free tissues
- Protective coat

⚠ Buffer oil is not a hazardous substance, but it is recommended to practice good industrial hygiene and safety practices, and to use this material in a well-ventilated space.

Filling the syringe

Step	Description
1	Remove the stopper from the syringe.
2	Install the needle.
3	Draw 1-2ml of the oil into the syringe.

De-gassing the buffer oil

Step	Description	Image
1	Invert the syringe so that the needle is facing up and pull any remaining oil out of the needle into the syringe.	
2	Remove the needle.	
3	Gently push the plunger to purge the air from the syringe.	
4	Install the stopper.	
5	Reverse the syringe so that the stopper is facing down.	
6	Draw out the plunger of the syringe past the 10ml point.	
7	Install the syringe kickstand so that it cups the plunger and supports it in the drawn-out position. The syringe will brace against the flange on the plunger and the barrel.	
8	Leave the syringe in the reverse position for about an hour.	
9	Remove the kickstand.	
10	Invert the syringe so that the tip is facing up.	
11	Remove the stopper.	
12	Purge any air from the syringe	



5.3 Cleaning the buffer tube

Required materials

- Foam stand, with cutouts for the MCBH ports
- Buffer fluid
- Syringe with a stopper and needle
- Syringe kickstand

All required materials for this procedure are provided with the [support kit](#).

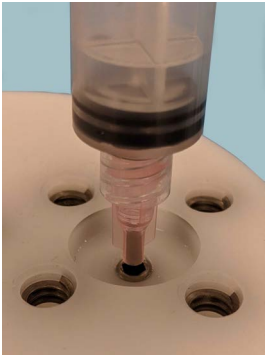
Cleaning the buffer tube by aspirating the buffer oil

Step	Description	Images
1	Remove the antifouling mesh assembly	
2	<p>Clean the buffer tube assembly</p> <ol style="list-style-type: none"> 1. Insert the needle into the buffer tube assembly, all the way 2. Draw out the plunger of the syringe past the 10ml point 3. Install the syringe kickstand so that it cups the plunger and supports it in the drawn-out position; the syringe will brace against the flange on the plunger and the barrel <div style="border: 1px solid yellow; padding: 5px; margin-top: 10px;"> <p> The syringe will draw up oil and any particles until the assembly is empty, and then, it will draw air.</p> </div>	 
3	Refill the buffer tube assembly	

Cleaning the buffer tube by purging with buffer oil

Debris can be removed from the buffer tube assembly by purging the assembly with buffer oil. This method will consume more oil, but it may be more effective in some situations.

Step	Description
1	<p>Prepare the instrument and the syringe</p> <ol style="list-style-type: none"> 1. Remove the antifouling mesh assembly 2. Remove the instrument from the foam stand and lay it on its side 3. Fill the syringe and de-gas the buffer oil
2	<p>Clean the buffer tube assembly</p> <ol style="list-style-type: none"> 1. Insert the needle into the buffer tube assembly, all the way 2. Depress the plunger and flush the buffer tube assembly 3. With the syringe still in the pressure port, stand the instrument with the port up 4. While depressing the plunger, remove the syringe
3	Refill the buffer tube assembly



5.4 Refilling the buffer oil





Required materials



- Foam stand, with cutouts for the MCBH ports
- 3mm and 5mm hex keys
- O-ring
- Silicone compound
- Buffer fluid
- Syringe with a stopper and needle
- Syringe kickstand
- Refill adaptor
- Four socket head cap screws

All required materials for this procedure are provided with the [support kit](#).

Refilling the buffer oil

Step	Description	Image
1	<p>Prepare the instrument</p> <ol style="list-style-type: none">1. Install your RBR$quartz^3$ Q plus into the foam stand, fitting the MCBH ports into the cutouts2. Remove the antifouling mesh assembly (see Removing the antifouling mesh assembly)3. Remove the four set screws around the pressure port using the 3mm hex key	
2	<p>Prepare the refill adaptor</p> <ol style="list-style-type: none">1. Apply a thin film of the silicone compound to the O-ring of the refill adaptor2. Install the O-ring into the refill adaptor as shown in the image	

Step	Description	Image
3	<p>Fill the buffer tube with oil</p> <ol style="list-style-type: none"> 1. Remove the stopper from the syringe 2. Install the needle 3. Invert the syringe so that the needle is point up 4. Purge the air from the needle by depressing the plunger until a drop of oil comes out 5. Insert the needle into the buffer tube assembly and fill it with oil to the top of the set screw 6. When extracting the needle, continue to apply pressure to the plunger to maintain the oil level 7. Draw the oil out of the needle and remove the needle 	
4	<p>Refilling the oil</p> <ol style="list-style-type: none"> 1. Install the refill adaptor to the syringe 2. Invert the syringe so that the refill adaptor is pointing up 3. Purge the air from the refill adaptor by depressing the plunger until a drop of oil sits at the adaptor opening <div style="border: 1px solid orange; padding: 5px; margin-top: 10px;"> <p> Ideally, the meniscus at the air-oil interface should be convex to minimize the air in the final assembly.</p> </div>	
5	<p>Install the refill adaptor</p> <ol style="list-style-type: none"> 1. Mate the refill adaptor to the pressure port 2. Install the four cap screws with the 5mm hex key <div style="border: 1px solid red; padding: 5px; margin-top: 10px;"> <p> Do not apply pressure to the plunger when the syringe is installed on the pressure port! Doing so may exceed the pressure rating of the sensor.</p> </div>	

Step	Description	Image
6	<p>De-gas the system</p> <ol style="list-style-type: none"> 1. Draw the plunger of the syringe just past the 10ml mark 2. Install the syringe kickstand so that it cups the plunger and supports it in the drawn-out position; the syringe will brace against the flange on the plunger and the barrel <div data-bbox="324 409 1071 562" style="border: 1px solid orange; padding: 5px; margin: 10px 0;"> <p>⚠ Bubbles will be coming out of the system through the oil into the syringe, drawn into the rarefied air. The rate of bubbles coming out should quickly start to reduce. If it is not happening, tighten the syringe to the refill adaptor and tighten the four cap screws.</p> </div> <ol style="list-style-type: none"> 3. Leave the syringe in this position for about an hour 4. Remove the kickstand, while keeping the syringe in place <div data-bbox="324 751 1071 829" style="border: 1px solid orange; padding: 5px; margin: 10px 0;"> <p>⚠ The plunger will drop back, almost to the surface of the oil, due to low pressure inside the syringe.</p> </div> <ol style="list-style-type: none"> 5. With everything still attached, draw the plunger of the syringe just past the 10ml mark again 6. Very gently, pump the plunger up and down approximately ten times, until no bubbles come out of the system after drawing the plunger 	
7	<p>Clean up and reassemble</p> <ol style="list-style-type: none"> 1. Remove the refill adaptor 2. Remove excess oil from the pressure port with a tissue or swab 3. Once cleaned, install the lower mesh insulator disk with the recess facing up 4. Place the nickel-copper mesh in the recess of the lower mesh insulator disk 5. Place the upper lower mesh insulator disk on top of the lower mesh insulator disk and nickel-copper mesh assembly 6. Open the split on the retaining ring and ease its middle into the sensor end-cap recession 7. Hold the retaining ring in place with one finger and feed the the rest of the ring into the sensor end-cap recession 	

6 External pressure adaptor

The external pressure adaptor is designed for the RBR*quartz*³ instruments and can be used to verify or recalibrate the Paroscientific Digiquartz[®] pressure sensor.

RBR provides the RBR*quartz*³ pressure adaptor kit with each instrument. It is not included in the RBR support kit and needs to be ordered separately. You can choose to receive this separate kit at the same time as the instrument, or to request it separately at a later date.

RBR*quartz*³ pressure adaptor kit includes:

- pressure adaptor
- four socket head cap screws
- 3mm and 5m hex keys
- five replacement O-rings



Pressure adaptor kit

Installing the adaptor

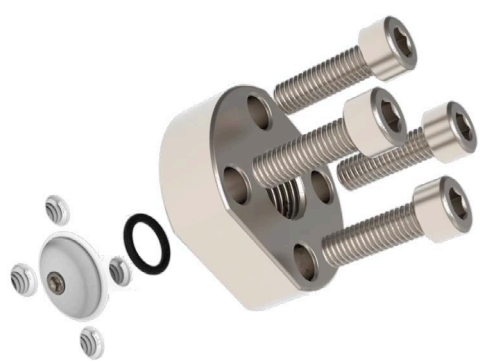
Step	Description	Image
1	Remove the antifouling mesh.	
2	Apply a thin layer of silicon compound to the O-ring.	
3	Install the O-ring into the O-ring groove of the external pressure adaptor.	
4	Position the external pressure adaptor over the exposed pressure port of the instrument.	
5	Install the four screws with a 5mm hex key and tighten them to 1/4 turn past snug (max 10 Nm torque).	

i Refer to [Removing the antifouling mesh assembly](#) for required materials and steps. Refer to [Replacing the O-ring](#) for additional instructions.

7 Repairs

RBR supports all our products. Contact us immediately at support@rbr-global.com or via the [RBR website](#) if there are any issues with your instrument. Please have the model and the serial number of the unit ready. Our support team will work to resolve the issue remotely. In some cases, you may have to return your instrument to RBR for further servicing.

 There are no user-repairable parts of the instrument. Any attempt to repair without prior authorisation from RBR will void the warranty. Refer to the [RBR warranty statement](#).

To return a product to RBR for an upgrade, repair, or calibration, please contact our [support team](#) to obtain a return merchandise authorisation code (RMA) and review the detailed shipping information on the [RBR website](#).

8 Revision history

Revision No.	Release date	Notes
A	17-March-2021	Initial release.
B	31-August-2021	Removed Appendix A (drawing), moved Appendix B (connector pinout diagram) to Specifications. Updated information on support kit contents, added information on external pressure adaptor kit. Removed the Warranty section (available on the RBR website). Minor updates throughout the document.
C	11-August-2023	Added guidance on horizontal deployment to the Orientation and datum location section. Added a warning to the Replacing the batteries section. Updated the Replacing the desiccant capsules section. Removed the Cables page (available as RBR Cable Guide).
D	31-December-2024	Updated the Specifications section for new deployment estimates. Updated the Calibration section for downloading instructions.

