

RBR *quartz*³ BPR INSTRUMENT GUIDE



rbr-global.com

Table of contents

1	RBR <i>quartz</i> ³ BPR	3
2	Specifications	4
3	Hardware	7
3.1	Opening and closing the instrument	7
3.2	RBR <i>quartz</i> ³ BPR interface	8
3.3	Orientation and datum location	10
3.4	Twist activation	11
4	Ethernet commands	12
5	Deployment	20
5.1	RBR <i>quartz</i> ³ BPR without Ethernet	20
5.2	RBR <i>quartz</i> ³ BPR with Ethernet	21
6	General maintenance	22
6.1	Support kit	22
6.2	Replacing the O-rings	23
6.3	Replacing the batteries	24
6.4	Replacing the desiccant capsules	25
6.5	Cables and connectors	27
6.6	Cleaning the instrument	28
6.7	Calibrating the instrument	28
7	Pressure sensor maintenance	29
7.1	Removing the antifouling mesh assembly	30
7.2	Filling the syringe and de-gassing the buffer oil	31
7.3	Cleaning the buffer tube	32
7.4	Refilling the buffer oil	33
8	External pressure adaptor	36
9	Repairs	37
10	Revision history	38

1 RBRquartz³ BPR

The RBRquartz³ BPR (Bottom Pressure Recorder) uses an integrated Paroscientific Digiquartz® pressure sensor for the best-in-class initial accuracy, resolution, and low drift performance. This instrument is intended for tsunami detection, tide monitoring, long-term water level studies, and high-resolution depth sensing in ROVs and AUVs.

High resolution and accuracy of the quartz pressure sensor enable water level observations in deepwater. Continuous measurements allow the RBRquartz³ BPR to be used for tsunami detection and early-warning systems when connected to a cabled realtime network. Flexible measurement schedules and configurable integration times permit applications for tide and sea level measurements when powered on internal batteries. A high-accuracy marine temperature sensor records temperature data with each pressure measurement.

Realtime data applications are enabled via USB, RS-232, RS-485, or Ethernet communication. Data transmission to a surface buoy can be performed inexpensively and reliably using the RBR MLM inductive modem system. Innovative canister design allows for easy access to the battery compartment and fast data download via USB-C. Datasets can be read directly in Matlab, or exported to Excel, OceanDataView®, or text files.

Key features of the RBRquartz³ BPR are:

- High accuracy
- Quartz stability
- Long deployments



RBRquartz³ BPR

The RBRquartz³ BPR may include an optional built-in tilt sensor (accelerometer).

For a detailed description of Ruskin software and its use for the RBRquartz³ BPR, refer to the [Ruskin User Guide: Standard Instruments³](#).

2 Specifications

Instrument

Specification	Description
Storage	240 million
Power	8 AA-type cells
External power	4.5 to 30V
Communications	Internal: USB-C External: USB and RS-232/RS-485, or Ethernet
Clock drift	±60 second/year
Maximum depth rating	7000m
Housing	Titanium
Diameter	60mm
Length	540mm
Weight	~3.3Kg in air, ~1.7Kg in water

Temperature sensor

Specification	Description
Range	-5 to 35°C*
Initial accuracy	±0.002°C
Resolution	0.00005°C
Typical stability	±0.002°C/year
Time constant	~30s (embedded)

*A wider temperature range is available upon request. Contact [RBR](#) for more information.

Pressure sensor

Specification	Description
Range	4000 / 7000dbar
Initial accuracy	±0.01% full scale
Resolution	10ppb (at 1Hz sampling rate)

Power supply selection

If connected, an external power supply will be used preferentially over the internal batteries as long as the voltage remains 4.5V or greater. If it drops below 4.5V or complete disconnection occurs, the system automatically switches to the internal batteries.

Clock

The instrument clock is maintained during brief disconnections. This time is usually sufficient to change batteries. If the clock is lost, the time will revert to January 2000. In this case, check the power supply and synchronise with the computer again.

USB-C power

The USB-C cable provides power sufficient for configuration or data download. However, the instrument requires an internal or external power supply to perform sampling.

Deployment estimates

Deployment times are estimated for lithium thionyl chloride batteries based on both memory and internal battery capacity.

Speed	Time	# of samples
16Hz	~58 days	~48 million
2s	~65 days	~1.5 million
10s	~322 days	~1.5 million
60s	~5 years	~1.5 million

External MCBH-6-MP connector pinout

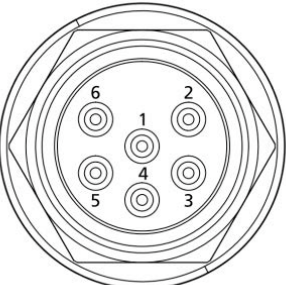
	Pin No.	USB	RS-232	RS-485	Ethernet
	1	Ground			
	2	Power 4.5V to 30V			
	3	N/C	Data output from the instrument (Tx)	TD (A)-	Data output from the instrument (Tx-)
	4	VUSB +5V	Data input into the instrument (Rx)	RD (B)+	Data input into the instrument (Rx+)
	5	D-	N/C	RD (A)-	Data input into the instrument (Rx-)
	6	D+	N/C	TD (B)+	Data output from the instrument (Tx+)

External MINK-10-FCR connector pinout

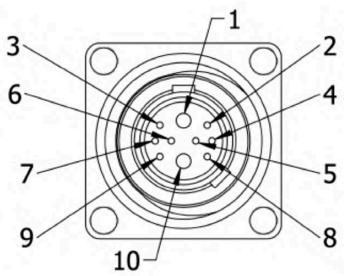
	Pin No.	RS-232	RS-485	Ethernet
	1	Power 4.5V to 30V		
	2	N/C	RD(A)	Data output from the instrument (Tx+)
	3	N/C	N/C	Data input into the instrument (Rx+)
	4	Data output from the instrument (Tx)	RD(B)+	Data output from the instrument (Tx-)
	5	Ground		
	6	Data input into the instrument (Rx)	TD(B)+	N/C
	7	N/C	N/C	Data input into the instrument (Rx-)
	8	N/C		
	9	N/C	TD(A)-	N/C
	10	Ground		



3 Hardware

3.1 Opening and closing the instrument

⚠ Remember to keep the O-rings clean and avoid scratching the O-ring mating surfaces. Carefully inspect the O-rings before deploying the instrument.

Opening the instrument with a standard end-cap

1. Twist the battery end-cap counterclockwise.
2. Once fully unscrewed, pull the end-cap away from the housing.

Closing the instrument with a standard end-cap

1. Place the end-cap back on the instrument.
2. Twist the end-cap clockwise until aligned with **PAUSE**.



Open instrument with a standard end-cap

Opening the instrument with a connectorised end-cap

1. Twist the battery end-cap counterclockwise.
2. Once fully unscrewed, pull the end-cap away from the housing.
3. For instruments with connectorised end-caps, unplug the umbilical cable.

Closing the instrument with a connectorised end-cap

1. Plug the mini-display port connector into the instrument as shown.
2. Twist the end-cap counterclockwise two full rotations to unwind the umbilical cable.
3. Place the end-cap back on the instrument.
4. Twist the end-cap clockwise until aligned with **PAUSE**.



Open instrument with a connectorised end-cap

3.2 RBR*quartz*³ BPR interface

The RBR*quartz*³ BPR instrument provides an internal USB-C port and several external communication options. Select from USB, RS-232, RS-485, and Ethernet at the time of order, and RBR will wire the battery end-cap to support your preferred external connection.

i Patch cables and underwater extension cables are sold separately.

i Refer to [Opening and closing the instrument](#) for details on accessing connection ports. Refer to [Specifications](#) for the external MCBH-6-MP and MINK-10-FCR connector pinout diagrams.

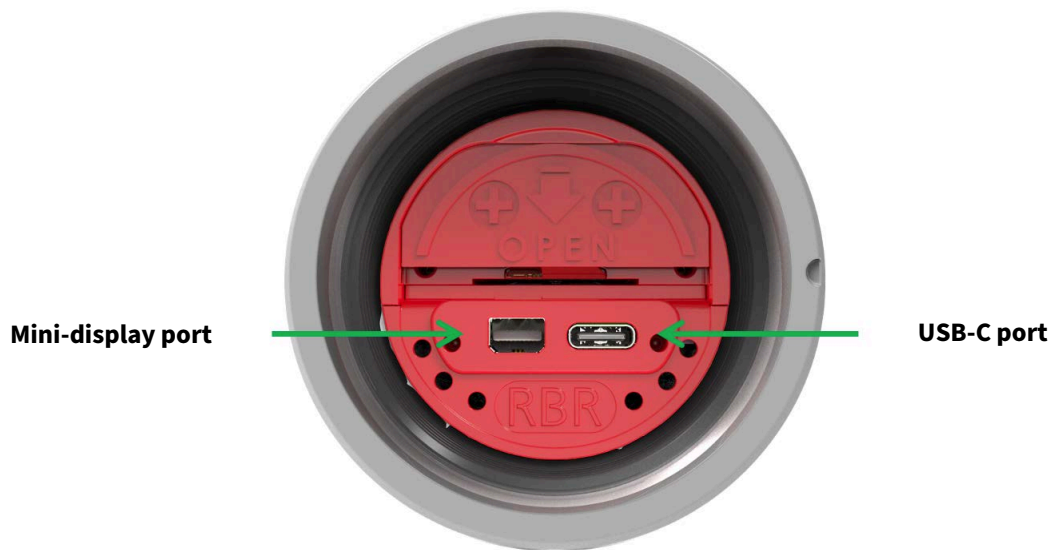

USB-C connection

Remove the battery end-cap to access the USB-C port located inside the instrument body.

A USB-C desktop cable is supplied in the instrument support kit. Use this cable to download data from the instrument to your computer.

Mini-display port

The mini-display port is located next to the USB-C port. This is the port to use for the umbilical cable from the connectorised end-cap.

End-cap types

The RBR*quartz*³ BPR loggers are compatible with several different end-caps. These end-caps are interchangeable between instruments.



Standard end-cap



Connectorised end-cap



Right-angle connectorised end-cap



Connectorised end-cap with MINK connector

MCBH and MINK connectors

Only connectorised battery end-caps have the external connector. Depending on your needs, the RBR*quartz*³ BPR may be wired to support the USB, RS-232, RS-485 communications, or Ethernet (selected at the time of order). Refer to [Specifications](#) for details.

 Patch cables and underwater extension cables are sold separately.

3.3 Orientation and datum location

Vertical deployment (recommended)

RBR performs an offset adjustment with the pressure sensor facing downwards, as shown in the first image. It is recommended to deploy the instrument vertically to match the way it was calibrated.

When deployed vertically, the datum for the pressure measurements for the RBR*quartz*³ BPR is located at the centre of the pressure sensor port, at the lowest surface of the instrument.

⚠️ Avoid deploying the instrument vertically with the sensor facing up! Such orientation will affect performance of the pressure sensor due to increased build-up of sediment.



**Recommended orientation:
sensor facing down**

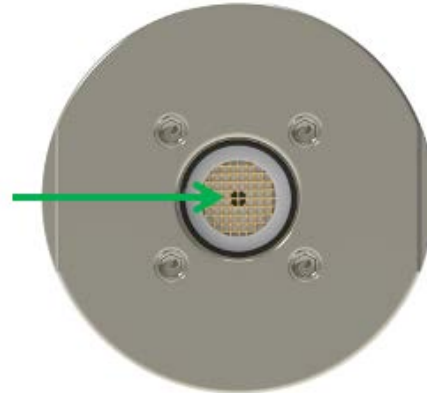

Datum location

Horizontal deployment

It is acceptable to deploy the RBR*quartz*³ BPR horizontally if necessary. Note that, with the instrument on its side, there will be a significant change to the datum due to the internal head values. Assess the correct offset to your preferred datum point before deployment.

3.4 Twist activation

All RBR Generation³ standard instruments are equipped with twist activation as a standard feature. See [Ruskin User Guide: Standard Instruments³](#).

Twist activation allows you to start or pause the instrument without the need to connect to a computer.

When you select "Twist activation" in Ruskin, the instrument starts to sample based on the twist **PAUSE/RUN** position rather than a schedule. To start sampling, first click "Enable" in Ruskin to enable logging. The status will then become "Paused". Turn the battery end-cap to the **RUN** position. The instrument will vibrate with one long pulse and start sampling. To pause it, turn the battery end-cap to the **PAUSE** position. The instrument will vibrate with three short pulses to indicate it has paused logging.



Twist activation mode: RUN

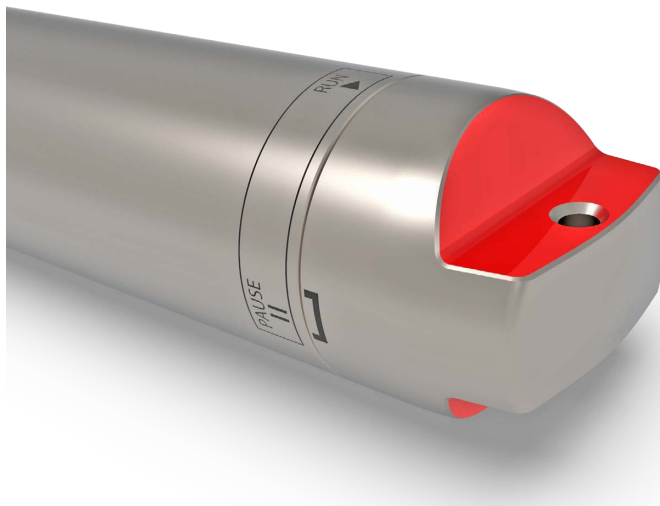

Twist activation mode: PAUSE

4 Ethernet commands

The RBR^{quartz} BPR with an MCBH or a MINK external connector may be wired to stream the data via the Ethernet. See the pinout diagrams in the [Specifications](#) section and the hardware structure of the instrument, in the block diagram below.

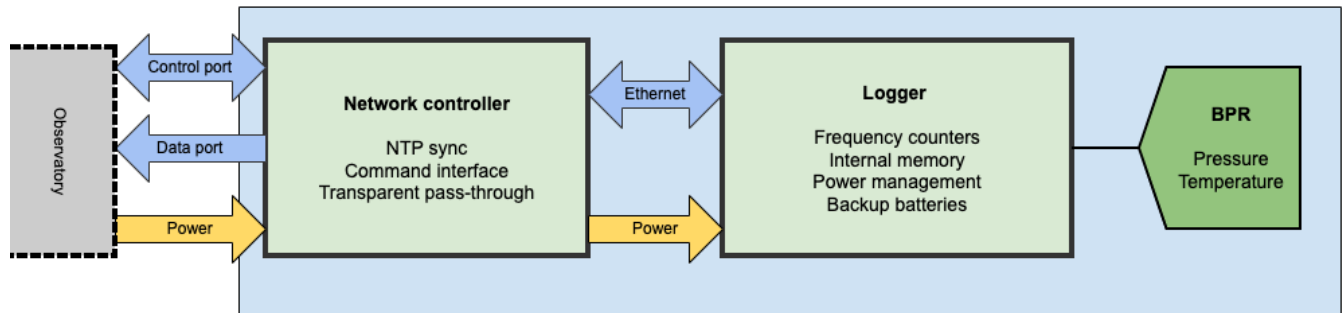

i You do not need to open your instrument to connect it to your network. Connect your terminal to the MCBH or a MINK external port using a compatible patch cable. The instrument will appear on your network.

1. IP connections

IP connections to the instrument are made via two different ports.

The first is the data port (23) which is a read-only socket where the client should simply listen for the measured data that is being streamed out. The second is the control port (2323) which permits some settings to be modified.

Upon connection to the control port (2323), there will be no immediate response or banner. You can enter commands by typing them in.

i When entering a command, terminate with linefeed. Any carriage returns will be ignored.

2. Performance and timing considerations

- Logger

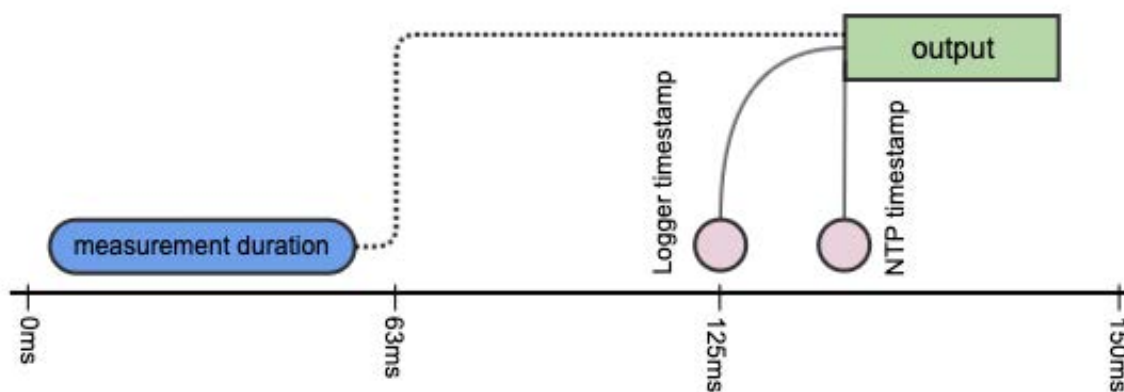

Logger readings will be timestamped no earlier than 63ms and no later than 125ms from when the reading was completed. The resolution of logger timestamps is 63ms. Logger output of the timestamped sample will occur within 63ms of the indicated timestamp.

- NTP-based tagging

The network controller associates each sample received from the logger with an NTP-based timestamp upon receiving the first character of the line of data from the logger. The resolution of NTP-based timestamps is 5ms. After receiving the entire sample, it is sent to the TCP connection within 5ms.

3. Starting up for the first time

In order to start the logger, use the transparent mode in the control interface and the following commands. These assume that the logger clock has been reset already, if of interest (`clock` command).

```
deployment starttime = 20000101000000, endtime = 20991231235959
sampling mode = continuous, period = 63
enable erasememory = true
```

4. Configuring network settings

To configure the network controller, download the Windows-only executable [IPSetup](#) binary required to run on a host on the same subnet (same UDP broadcast domain) as the instrument.

In its default state, the instrument will attempt to acquire network configuration information via DHCP. Using IPSetup, configure the static IP address, network mask, gateway, and DNS server of the instrument. No other settings in IPSetup should be changed at risk of an invalid configuration requiring the instrument to be returned to RBR for service.

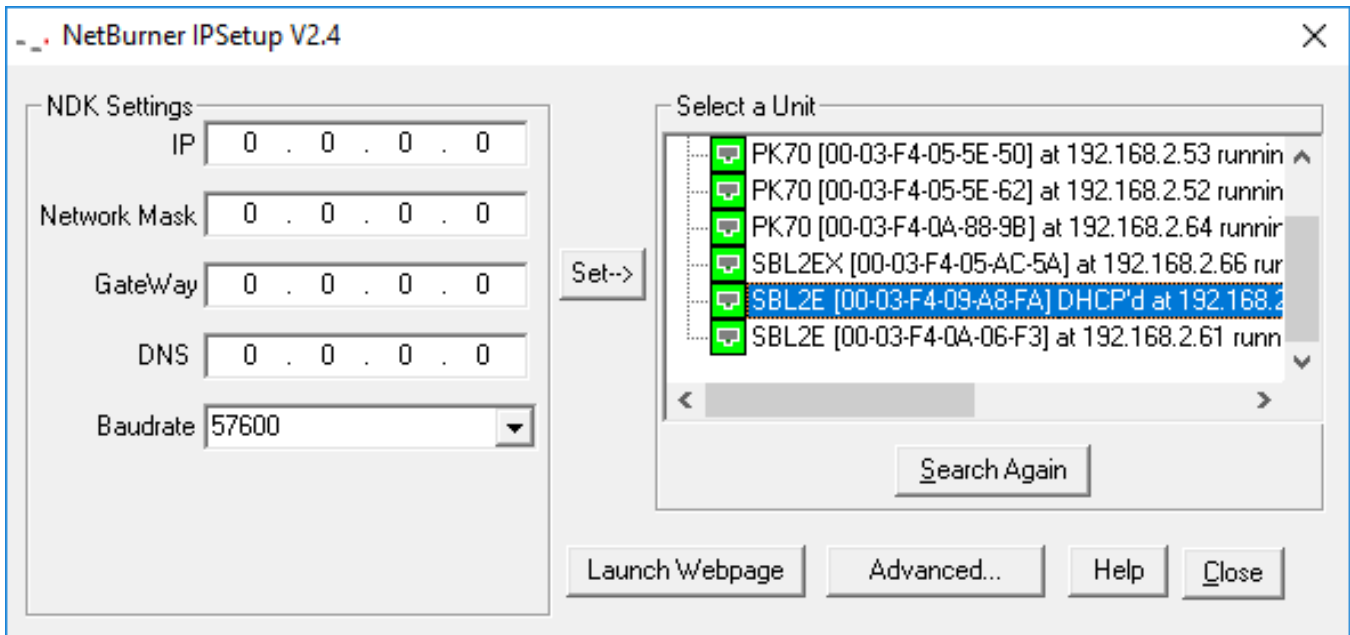

5. Periodic stop-erase-start procedure

```
disable
enable erasememory = true
```

As the instrument has a linear memory, in order to provide protection for a possible network outage it is important to periodically stop the logging, erase the memory, and restart. This process should take less than ten seconds, during which there will be no streaming data, nor logged data. As the logger memory will fill in ~25 days, this process should be followed every 20 days (or 3 weeks) to give some margin for human error.

6. Procedure after an observatory outage

```
<download while still running - may take hours or days>
// chunksize := 500
// offsetdataread := 0
>> meminfo
<< meminfo used = YYY
// totalsize := YYY
// while (offsetdataread < totalsize) {
// while (offsetdataread < totalsize) {
>> readdata dataset = 1, size = chunksize, offset = offsetdataread
<< readdata dataset = 1, size = nbytesread, offset = 2000 offsetread<cr><lf><bytes[0...
nbytesread]-of-data><crc>
// if crc ok
// {
// append bytes read to output file
// offsetdataread := offsetdataread + nbytesread
// }
// }
>> meminfo
<< meminfo used = YYY
// totalsize := YYY
// }
<end of download>
>> disable
>> enable erasememory=true
```

The download can be performed by reading all the bytes in dataset 1 and writing them in a *.bin file. Ruskin is able to read directly those files.

For more details on the **read** and **meminfo** commands and the CRC calculation, please refer to the [L3 command reference](#).

7. Stopping the instruments and preparing for shipment

```
disable
```

The only command required to be sent to the logger (using the transparent mode in the control interface) is `disable`. The control interface will still be active but may be powered down by removing the patch cable. The internal batteries will continue to provide backup power to the logger RTC (~10uA) and will last for many years in this state.

8. Control port commands

Upon connection to the control port (2323), there will be no immediate response nor banner. If the command required is known, it can be entered immediately (all commands are terminated with line-feed, and any carriage returns are ignored). If the commands are not known, the question mark ("?") command can be used to display the network controller control menu.

The control port connection supports a single connection. It is important that the connection is closed after use, permitting others to establish connections if necessary.

```
----- RBRquartz3 BPR NETWORK INTERFACE CONTROL MENU -----  
  
D: Display current settings  
S: Set NTP source  
R: Set NTP refresh rate  
J: Set the timestamp jump tolerance  
E: Set the transparent mode inactivity timeout  
T: Enter transparent mode  
!: Exit transparent mode (once in transparent mode)  
Q: Close this connection  
#: Reset the RBRquartz3 BPR network interface  
?: Print this menu
```

- D: Display current settings

```
RBRquartz3 BPR Network Interface v1.5.1  
Uptime: 0 days 00:13:03.340  
Current time: 2021-05-10 15:11:48.248  
System parameters  
-----  
NTP time sync rate (min):          1  
NTP source:                        NTP pool  
Timestamp jump tolerance (s):      1800  
Transparent mode inactivity timeout (s): 10  
Last valid time sync:              2021-05-10 15:11:02.934
```

The current settings shown include:

- Uptime: approximate time since the last reboot - either due to power up or the # reset command.
- Current time: this clock is maintained according to the NTP settings.
- NTP time sync rate: frequency at which the NTP source is polled to correct for clock drift. See R command.
- NTP source: Either the IP address of the NTP server or the phrase "NTP pool". See the S command.
- Timestamp jump tolerance: time tolerance in seconds for the difference in the logger clock between two subsequent samples. (Only when the new sample is in the future)
- Transparent mode inactivity timeout: timeout for leaving transparent mode if no input is received in the set amount of time.
- Last valid time sync: the last time at which a successful poll of the NTP source occurred.

- S: Set NTP source

Enter NTP source (IP address, a.b.c.d).
To use pool.ntp.org, enter 0.

By default, the [NTP Pool](#) will be used as the source of NTP times. A custom NTP server can be used by providing its IP address.

Whenever this value is changed, an NTP poll is performed immediately and the schedule for polling is restarted.

- R: Set NTP refresh rate

Enter the NTP refresh rate (number of minutes, 1-60; default: 1):

The frequency with which time is polled from the NTP source can be adjusted.

Whenever this value is changed, an NTP poll is performed immediately and the schedule for polling is restarted.

- J: Set the timestamp jump tolerance

Enter the timestamp jump tolerance (number of seconds, 1-86400; default: 1800):

The time tolerance between two subsequent instrument samples to trigger a clock sync with the logger. This will accommodate cases where the logger is reconfigured externally.

- E: Set the transparent mode inactivity timeout

Enter the transparent mode inactivity timeout (number of seconds, 10-60; default: 10):

The time for exiting transparent mode automatically if no commands are issued in that time frame.

- T: Enter transparent mode

```
Data streaming off
Transparent mode on
```

To communicate with the instrument directly, use the `T` command to enter transparent mode. Upon entering transparent mode, the instrument's streaming output will be automatically disabled. While in transparent mode no output will be sent to the data client; however, any connections to the data port will remain open and will resume receiving data when transparent mode is closed. Upon leaving transparent mode, the streaming output of the instrument will be automatically re-enabled (providing that the instrument is enabled).

There are two ways of leaving transparent mode: manually escaping with the `!` character (described below), and an automatic configurable idle timeout. If 10 seconds, or the set time, elapse without characters being received by the network controller, transparent mode will automatically be closed and streaming output will be restarted.

Transparent mode is maintained across multiple control client connections. If the control client is disconnected without escaping from transparent mode (i.e., by abruptly terminating the socket connection), future connections will be placed directly into transparent mode (unless the idle timeout has been exceeded).

- `!`: Exit transparent mode (once in transparent mode)

```
Data streaming on
Transparent mode off
```

When in transparent mode, send a `!` character to immediately leave the mode and restart instrument streaming.

See the notes for the `T` command for details on the behaviour of the data port upon leaving transparent mode.

- Q: Close this connection

```
Connection closed by foreign host.
```

Explicitly close the connection to the control port.

- #: Reset the BPR network controller

```
Resetting server. All connections will be lost!
Connection closed by foreign host.
```

The control interface is reset by this command, a process that takes <10s. All network connections are lost and will have to be re-established. The network controller clock is reset to the beginning of 1970, but the first NTP sync should be done by the time the first connection is made.

- `?`: Print this menu

Displays the menu as shown above.

8. Data port format

The data port provides read-only data and does not respond to any commands.

9. Sample data

The format of the data is as follows:

#	Name	Format	Notes
1	Logger time NTP offset corrected	YYYY-MM-DD HH:MM:SS.sss format.	The time that the internal logger reports corrected with the latest NTP offset. The current NTP time may be examined using the <code>D</code> command via the control interface.
2	Logger time	YYYY-MM-DD HH:MM:SS.sss format.	The time that the internal logger reports. This clock may be read and set using the <code>now</code> command via transparent mode. Drift should be $\pm 60s/\text{year}$.
3	BPR temperature (C)	Double precision (64 bit) floating-point number.	The temperature derived from the BPR.
4	BPR pressure (dbar)	Double precision (64 bit) floating-point number.	The pressure derived from the BPR.
5	BPR pressure period (ps)	Double precision (64 bit) floating-point number.	The period of the pressure channel of the BPR.
6	BPR temperature period (ps)	Double precision (64 bit) floating-point number.	The period of the temperature channel of the BPR.

```
2021-05-06 19:03:37.924, 2021-05-06 15:03:37.000, 26.141700000, 9.235400000,
30284722.000000000, 5752694.000000000
```

One variation to the normal data format will occur when an internal error occurs. This error usually happens on a single channel at a time, and is most often caused by a failed electrical connection so that no valid readings are available. If this occurs, it will look like the following sensor error example:

```
2021-05-06 19:03:39.924, 2021-05-06 15:03:39.000, Error-9, 9.232900000,
30284722.000000000, 5752694.000000000
```

All errors should be reported to RBR for investigation.

10. Events

- All events obey the following format:

```
#EVENT_NAME, timestamp, eventPayload1, eventPayload2, ..., eventPayloadn- 1,
eventPayloadn
```

EVENT_NAME is a string name for the event

timestamp is the time at which the event occurred; depending on the event type, this may correspond to a corrected sample time

eventPayload1 ... eventPayloadn are the payload values for the event

- NTP synchronization events

When an NTP synchronization occurs, one #NTPSYNC event will be generated on the output:

```
2021-05-06 19:03:38.924, 2021-05-06 15:03:38.000, 26.141700000, 9.235400000,
30284722.000000000, 5752694.000000000
#NTPSYNC, 2021-05-06 19:03:39.924, 2021-05-06 15:03:39.000, 924
2021-05-06 19:03:39.924, 2021-05-06 15:03:39.000, 26.141700000, 9.235400000,
30284722.000000000, 5752694.000000000
```

#NTPSYNC corresponds to an NTP offset adjustment

Its timestamp is the logger time for the sample on which synchronization occurred corrected with the new NTP offset

eventPayload1 is the logger time for the sample on which synchronization occurred

eventPayload2 is the new NTP offset in milliseconds

5 Deployment

Deployment procedure of the RBR*quartz*³ BPR depends on its end-cap, which may have no connector, an external connector wired for USB, RS-232, or RS-485, or an external connector wired for Ethernet. See the pinout diagrams in the [Specifications](#) section.

You will require a patch cable and/or adaptor compatible with your instrument configuration. These are included with the instrument if requested at the time of order.

5.1 RBR*quartz*³ BPR without Ethernet

At the time of order, you can request your RBR*quartz*³ BPR wired for USB, RS-232, or RS-485. See [RBR*quartz*³ BPR interface](#) for more details on end-cap types.

Use Ruskin software to manage the deployment of any RBR*quartz*³ BPR variant without Ethernet.

Connecting to Ruskin

If your RBR*quartz*³ BPR has a connectorised end-cap, you do not need to open it. Simply connect your instrument to your computer using a compatible patch cable and it will appear on Ruskin.

 Patch cables are sold separately. They will be shipped with your instrument if requested at the time of order.

If your RBR*quartz*³ BPR has a standard end-cap with no external connector, follow the steps below to access the internal USB-C port.

1. Remove the battery end-cap. See [Opening and closing the instrument](#).
2. Locate the USB-C port inside the housing, next to the battery cover.
3. Plug one end of the the USB cable (USB-C to USB-C, provided with your instrument) into this port and the other, in the USB port on your computer.
4. The instrument will appear on Ruskin.

Deploying the RBR*quartz*³ BPR

1. On Ruskin, select the required sampling mode and speed.
2. Select "UTC" or "Local" to synchronise the instrument clock to the computer.
3. Choose whether to start "now" or at a future point in time.
4. Review the estimated end date to ensure it fulfils the deployment requirements. Longer deployments can be achieved with better battery chemistry or lower sampling speeds.
5. Click "Enable" to start the deployment.

For a detailed description of Ruskin software and its use for the RBR*quartz*³ BPR, refer to the [Ruskin User Guide: Standard loggers³](#).

5.2 RBRquartz³ BPR with Ethernet

At the time of order, you can request your RBRquartz³ BPR wired for Ethernet and power. See [RBRquartz³ BPR interface](#) for more details on end-cap types.

 You do not need to open the instrument to connect it to your network. Follow the steps below.

Deploying the RBRquartz³ BPR

1. Connect your terminal to the MINK or MCBH port located outside the instrument body using a compatible patch cable. The instrument will appear on your network.
2. Connect to the control port (2323).
3. Enter the question mark ("?",) command, terminated with linefeed, to display the network controller control menu.

```
----- RBRquartz3 BPR NETWORK INTERFACE CONTROL MENU -----D: Display current
settings
S: Set NTP source
R: Set NTP refresh rate
J: Set the timestamp jump tolerance
E: Set the transparent mode inactivity timeout
T: Enter transparent mode
!: Exit transparent mode (once in transparent mode)
Q: Close this connection
#: Reset the RBRquartz3 BPR network interface
?: Print this menu
```

4. Enter "T" to enable the transparent mode.
5. Enter "clock" to reset the instrument clock if necessary.
6. Enter deployment parameters, for example:

```
deployment starttime = 20000101000000, endtime = 20991231235959
sampling mode = continuous, period = 63
```

7. Erase the memory and start the deployment.

```
enable erasememory = true
```

 For more information on deploying the RBRquartz³ BPR with Ethernet, see [Ethernet commands](#).

6 General maintenance

6.1 Support kit



RBR support kit

RBR provides one support kit per every three instruments ordered. If you need more units, contact [RBR](#).

The RBR support kit contains an assortment of basic accessories and spare parts, as presented below.

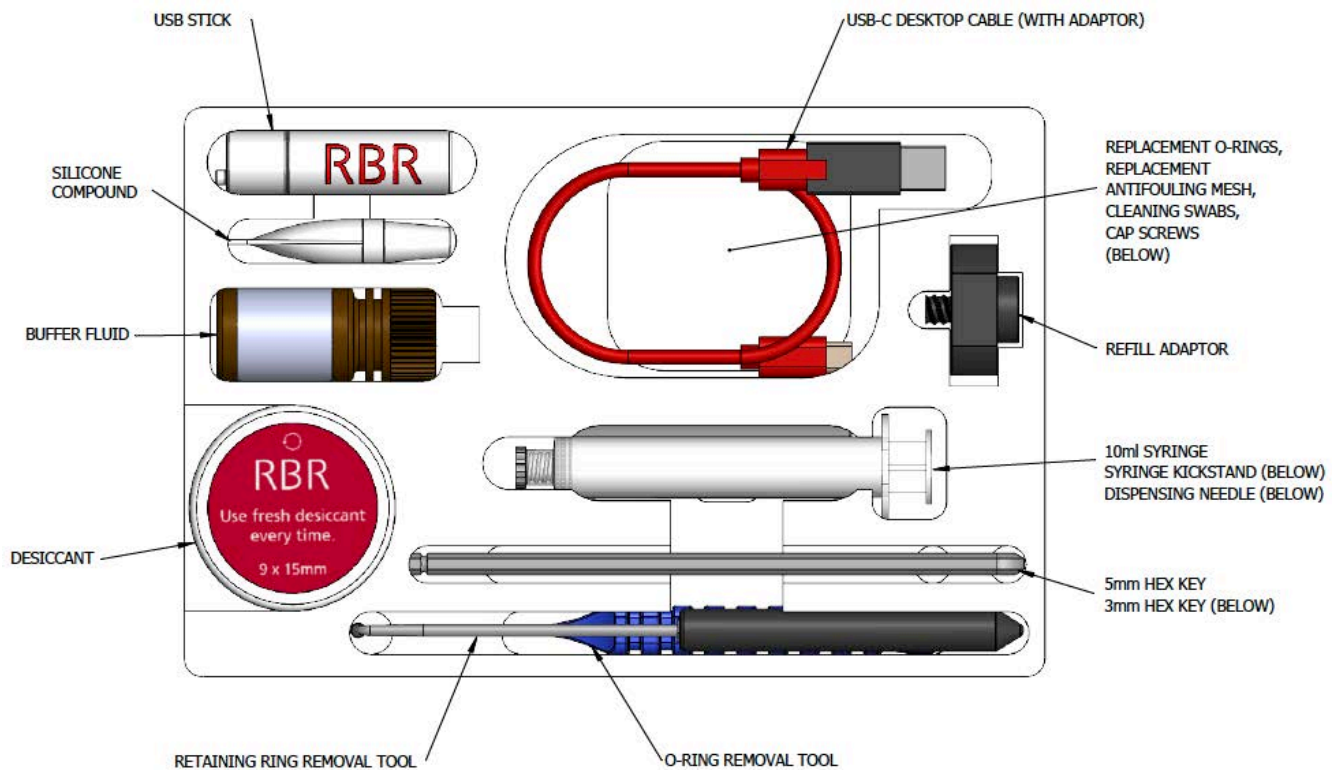

RBRquartz³ support kit diagram

6.2 Replacing the O-rings

i Refer to [Opening and closing the instrument](#) for details on accessing the O-rings. The O-ring removal tool and silicone compound are available in the [support kit](#).

Care for the O-rings is the single most important item of maintenance on any submersible RBR instrument. A water leak can damage the circuit board beyond repair and cause complete data loss. Every instrument's seal depends upon its O-rings, not the end-cap tightness. Therefore, proper O-ring maintenance is crucial.

i The O-ring may lose elasticity over time, even when the instrument is not deployed. RBR strongly recommends replacing the O-ring regularly.

O-rings on the BRquartz³ BPR

The BRquartz³ BPR instruments use two O-rings. One is the main O-ring, and the other is the backup. Both are required to protect the instrument from flooding. To access the O-rings, open the instrument.

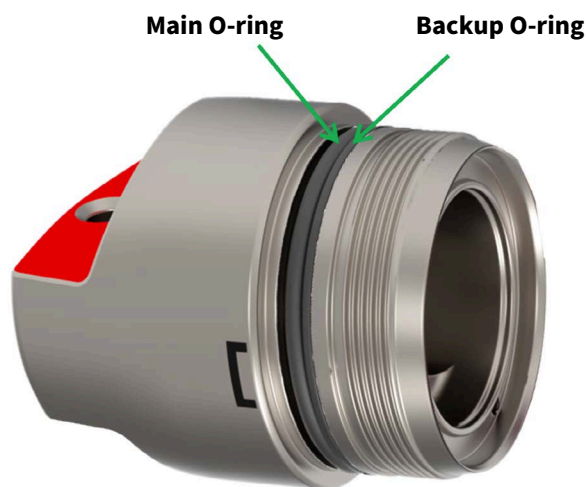

Location of the O-rings

Inspecting the O-rings

Visually inspect each new O-ring for nicks and scratches before installing it. Pay attention to the following areas:

- The surface of the O-ring itself
- The mating surface on the inside of the case between the threads and the open end
- The groove in the end-cap where the O-ring sits



When handling the O-rings:

- Avoid using any object that could scratch the O-ring or any of its mating surfaces.
- If dirt is present in the O-ring groove, remove the O-ring as described below and thoroughly clean the groove.
- Do not return this old O-ring to the instrument! If you remove the O-ring from the instrument for any reason, always replace it with a new one.
- If the surfaces of the O-ring groove are scratched, pitted, or damaged, contact RBR for advice.

Replacing the O-rings

Correct placement and orientation of the two O-rings are critical to maintaining depth rating integrity.

The main O-ring has a round profile. It must be installed first.

The backup O-ring is flat on one side, and concave on the other. When installed, the concave side must face the main O-ring.

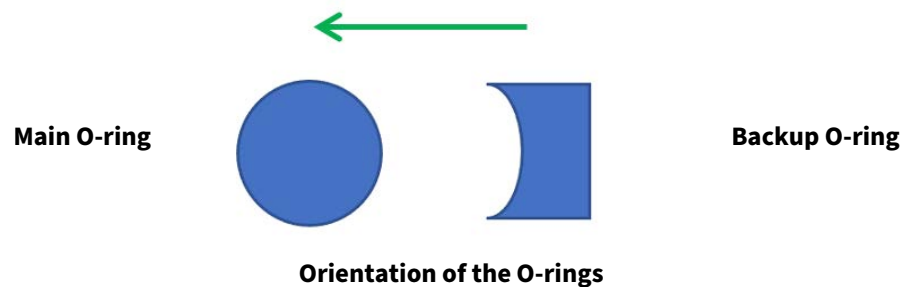

Do not use metal screwdrivers or any other metal tool! They may scratch the O-ring groove and render the end-cap useless.

1. Use the plastic O-ring removal tool (included in the support kit) to remove the old O-ring from its groove. The O-ring may need to stretch quite a bit as it is pushed off. This requires some effort, but can be done by hand.
2. Clean the groove thoroughly with a soft, lint-free cloth and compressed air, if necessary.
3. Select a new O-ring and inspect it for damage.
4. Lubricate with a very light film of silicone compound (included in the support kit).
5. Install the main O-ring by pushing it into place and popping it into its groove.
6. Install the backup O-ring, making sure the concave side is facing the main O-ring.
7. Once in place, inspect the O-rings once more for scratches and debris, and wipe away any silicone compound deposited on the end-cap.
8. Close the instrument.

6.3 Replacing the batteries



Refer to [Opening and closing the instrument](#) for details on accessing the batteries.

RBR ships new instruments with fresh, highest capacity batteries included. Replace the batteries before each deployment to maximise the operational time and prevent data loss.

Ruskin software estimates the remaining battery life during deployment by tracking power consumption in mAh. When setting up your deployment on Ruskin, check "Fresh" to indicate that new batteries are installed.

If using the same batteries for a subsequent deployment, do not check "Fresh" and continue power tracking from the previously recorded level.

See [Ruskin User Guide: Standard Instruments³](#) for more information on predicting battery life.



RBR standard instrument with batteries removed

Replacing the batteries

1. Remove the battery end-cap.
2. Using both thumbs, press down on the "+" symbols on the battery cover and slide in the direction of the arrow.
3. Remove the eight old batteries from the battery carriage.
4. Insert eight new batteries.
5. Check for correct battery polarity.
6. Put the end-cap back on the instrument and twist clockwise until aligned with **PAUSE**.

⚠ Always remove the batteries from your instrument during long-term storage!
Doing so will prevent internal damage due to battery leakage and/or corrosion.

6.4 Replacing the desiccant capsules

Replace desiccant capsules before each deployment.

Fresh desiccant will keep the instrument compartment dry and prevent malfunction. Water damage may occur if condensation forms inside the instrument.

As a preventative measure, RBR recommends servicing the instrument in a cool, dry place (when possible).

Replacing desiccant capsules

1. Remove the battery end-cap.
2. Remove the used desiccant capsules from their sockets.
3. Insert fresh desiccant capsules into their sockets, face out.
4. Once all the capsules are secured, place the battery end-cap back in its place.
5. Put the end-cap back on the instrument and twist clockwise until aligned with **PAUSE**.



Location of the desiccant capsules



Direction of insertion

All instruments ship with fresh reusable desiccant capsules. They use a cobalt-free colour changing indicator dye. Orange indicates fresh desiccant, while green indicates it is saturated (about 15% water by weight). Once exhausted, the capsules can be replaced with new ones (available from RBR), or refreshed.



Fresh (orange) and saturated (green) desiccant capsules

Refreshing the desiccant

Follow the steps below to refresh the desiccant.

1. Remove the saturated silica beads from their capsule.
2. Place them in the oven and heat at 120°C (250°F) for about two hours.

⚠ Always remove the beads from their capsule before refreshing!
The capsule will deform if heated to 120°C.

3. Take the refreshed beads out of the oven and return them to the capsule.

⚠ Return the refreshed beads to the capsule immediately after reheating!
If left outside the capsule, the desiccant will trap moisture and go back to green.

4. Wait until the silica beads cool down. Once cool, the desiccant is ready to be reused.

6.5 Cables and connectors

Cable bend radius

The smallest bend radius for RBR supplied cables is 15cm.

Lubricating the connectors

Lubrication improves watertight sealing, prevents corrosion, and reduces the force required to de-mate the connector. Use the silicone compound provided with your instrument.

- Apply the silicone compound to all female connectors before every mating
- Ensure each connector hole is filled with approximately 30% lubricant

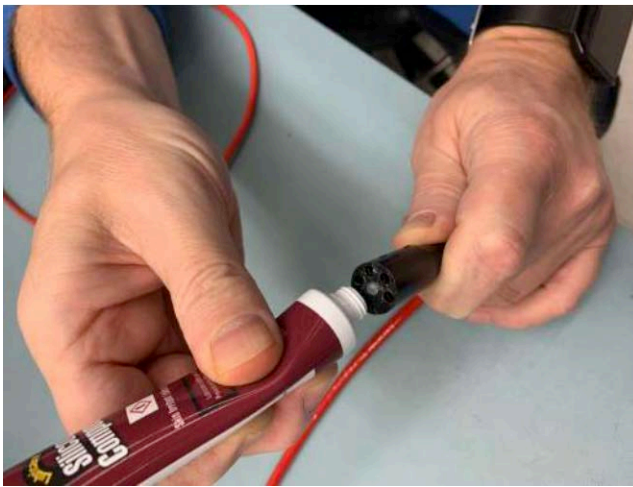

Lubricating a connector

Reducing mechanical stress

- Do not pull on the cable
- Hold onto the connector to pull out the cable
- Disconnect by pulling straight out, not at an angle
- Avoid sharp bends at the point where the cable enters the connector
- Avoid angular loads on the connector

6.6 Cleaning the instrument

Clean the instrument after each extended deployment to remove deposits that may have accumulated.

Type	Procedure	Notes
General/biofouling	To clean the exterior, soak in a mild detergent, then scrub the instrument with a soft brush.	Avoid scratching the plastic (scratches make future cleaning more difficult).
Sensor antifouling mesh	Scrub the antifouling mesh with a soft brush. Replace the antifouling mesh if needed.	See instructions on removing the antifouling mesh for more information.
Calcification	Soak in vinegar for six hours, then scrub the surface using a soft brush.	Soaking in vinegar for more than 24 hours may damage the O-ring and increase the chances of a leak.

6.7 Calibrating the instrument

Factory calibration coefficients are calculated for each sensor, and the coefficients are stored on the instrument.

RBR calibration certificates contain calibration equations, coefficients, and residuals for each sensor. Hard copies are provided with each shipment. RBR can replace lost or misplaced calibration certificates upon request.

RBR recommends calibrating your instrument before any critical deployment, periodically once a year, or if you suspect the readings to be out of specifications.

Discuss your calibration requirements with RBR. In some cases, the instrument will need to be returned to RBR to have it checked and recalibrated.

Please contact [RBR](#) for our current calibration fees.

7 Pressure sensor maintenance

All instruments in the RBR*quartz*³ family use Paroscientific Digi*quartz*[®] pressure sensors which require specific maintenance.

 The instructions below apply to the latest variant of the RBR*quartz*³ BPR, which has four set screws at the sensor end-cap. Earlier variants have a single set screw in the centre, under the antifouling mesh.

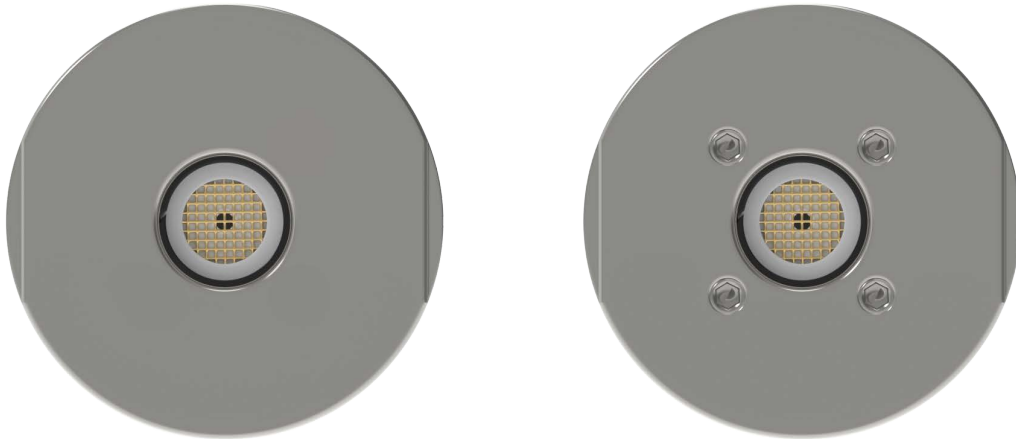

RBR*quartz*³ BPR sensor end-caps

Left: earlier variant, right: current variant

Examine the sensor end-cap of your instrument before proceeding.







If your RBR*quartz*³ BPR appears to have only one set screw like in the left image, it is an earlier variant. In this case, contact our [support team](#) for advice on pressure sensor maintenance.

If it has four screws like in the right image, follow the instructions below to clean the buffer tube and refill the oil.

7.1 Removing the antifouling mesh assembly

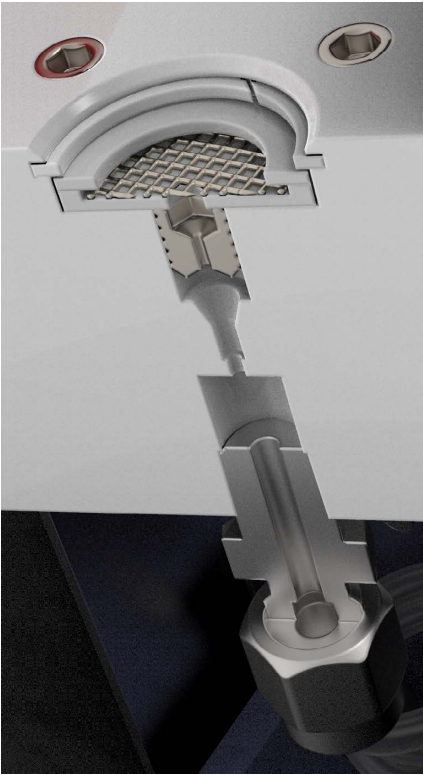
Removing the antifouling mesh assembly may be necessary for a variety of reasons, such as cleaning the instrument and its buffer tube, or installing the external pressure adaptor. Follow the steps below.

1. Remove the retaining ring using the removal tool. Hook the split in the ring at the opening and pull it out of the recess in the sensor end-cap.
2. The upper mesh insulator disk, nickel-copper mesh, and the lower mesh insulator disk will come out easily once the retaining ring is removed.

Item No.	Description	Part image	Assembled antifouling mesh	Buffer tube interface assembly
1	Lower mesh insulator disk			
2	Nickel-copper mesh			
3	Upper mesh insulator disk			
4	Retaining ring			

 Replacement parts are available in the [support kit](#).

7.2 Filling the syringe and de-gassing the buffer oil

i All required materials for this procedure are provided in the [support kit](#).

It is important to remove all gases from the system as they can form bubbles and cause anomalies in the data. Refill the system with de-gassed oil any time when cleaning it, or if it has had an oil leak for any reason.

Required materials

- Buffer fluid
- Syringe with a stopper and needle
- Syringe kickstand

Recommended handling materials

- Latex or nitrile gloves
- Lint-free tissues
- Protective coat

⚠ Buffer oil is not a hazardous substance, but it is recommended to practice good industrial hygiene and safety practices, and to use this material in a well-ventilated space.

Filling the syringe

Step	Description
1	Remove the stopper from the syringe.
2	Install the needle.
3	Draw 1-2ml of the oil into the syringe.

De-gassing the buffer oil

Step	Description	Image
1	Invert the syringe so that the needle is facing up and pull any remaining oil out of the needle into the syringe.	
2	Remove the needle.	
3	Gently push the plunger to purge the air from the syringe.	
4	Install the stopper.	
5	Reverse the syringe so that the stopper is facing down.	
6	Draw out the plunger of the syringe past the 10ml point.	
7	Install the syringe kickstand so that it cups the plunger and supports it in the drawn-out position. The syringe will brace against the flange on the plunger and the barrel.	
8	Leave the syringe in the reverse position for about an hour.	
9	Remove the kickstand.	
10	Invert the syringe so that the tip is facing up.	
11	Remove the stopper.	
12	Purge any air from the syringe	



7.3 Cleaning the buffer tube

i All required materials for this procedure are provided in the [support kit](#).

Required materials

- Buffer fluid
- Syringe with a stopper and needle
- Syringe kickstand

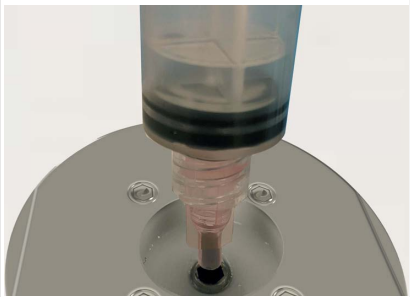
Cleaning the buffer tube by aspirating the buffer oil

Step	Description	Images
1	Remove the antifouling mesh assembly	
2	<p>Clean the buffer tube assembly</p> <ol style="list-style-type: none"> 1. Insert the needle into the buffer tube assembly, all the way 2. Draw out the plunger of the syringe past the 10ml point 3. Install the syringe kickstand so that it cups the plunger and supports it in the drawn-out position; the syringe will brace against the flange on the plunger and the barrel <div style="border: 1px solid orange; padding: 5px; margin-top: 10px;"> <p>⚠ The syringe will draw up oil and any particles until the assembly is empty, and then, it will draw air.</p> </div>	 
3	Refill the buffer tube assembly	

Cleaning the buffer tube by purging with buffer oil

Debris can be removed from the buffer tube assembly by purging the assembly with buffer oil. This method will consume more oil, but it may be more effective in some situations.

Step	Description
1	<p>Prepare the instrument and the syringe</p> <ol style="list-style-type: none"> 1. Remove the antifouling mesh assembly 2. Remove the instrument from the foam stand and lay it on its side 3. Fill the syringe and de-gas the buffer oil
2	<p>Clean the buffer tube assembly</p> <ol style="list-style-type: none"> 1. Insert the needle into the buffer tube assembly, all the way 2. Depress the plunger and flush the buffer tube assembly 3. With the syringe still in the pressure port, stand the instrument with the port up 4. While depressing the plunger, remove the syringe
3	Refill the buffer tube assembly



7.4 Refilling the buffer oil



 All required materials for this procedure are provided in the [support kit](#).

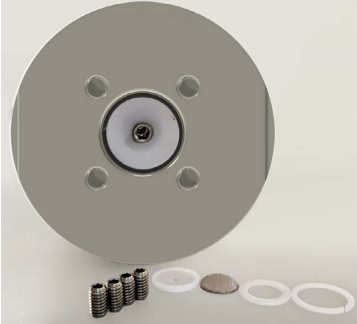

Required materials

- 3mm and 5mm hex keys
- O-ring
- Silicone compound
- Buffer fluid
- Syringe with a stopper and needle
- Syringe kickstand
- Refill adaptor
- Four socket head cap screws

Refilling the buffer oil

Step	Description	Images
1	<p>Prepare the instrument</p> <ol style="list-style-type: none">1. Remove the antifouling mesh assembly (see Removing the antifouling mesh assembly)2. Remove the four set screws around the pressure port using the 3mm hex key	
2	<p>Prepare the refill adaptor</p> <ol style="list-style-type: none">1. Apply a thin film of silicone compound to the O-ring of the refill adaptor2. Install the O-ring into the refill adaptor as shown in the image	

Step	Description	Images
3	<p>Fill the buffer tube with oil</p> <ol style="list-style-type: none"> 1. Remove the stopper from the syringe 2. Install the needle 3. Invert the syringe so that the needle is point up 4. Purge the air from the needle by depressing the plunger until a drop of oil comes out 5. Insert the needle into the buffer tube assembly and fill it with oil to the top of the set screw 6. When extracting the needle, continue to apply pressure to the plunger to maintain the oil level 7. Draw the oil out of the needle and remove the needle 	
4	<p>Refilling the oil</p> <ol style="list-style-type: none"> 1. Install the refill adaptor to the syringe 2. Invert the syringe so that the refill adaptor is pointing up 3. Purge the air from the refill adaptor by depressing the plunger until a drop of oil sits at the adaptor opening <div style="border: 1px solid orange; padding: 5px; margin-top: 10px;"> <p>⚠ Ideally, the meniscus at the air-oil interface should be convex to minimise the air in the final assembly.</p> </div>	
5	<p>Install the refill adaptor</p> <ol style="list-style-type: none"> 1. Mate the refill adaptor to the pressure port 2. Install the four cap screws with the 5mm hex key <div style="border: 1px solid red; padding: 5px; margin-top: 10px;"> <p>⚠ Do not apply pressure to the plunger when the syringe is installed on the pressure port! Doing so may exceed the pressure rating of the sensor.</p> </div>	

Step	Description	Images
6	<p>De-gas the system</p> <ol style="list-style-type: none"> 1. Draw the plunger of the syringe just past the 10ml mark 2. Install the syringe kickstand so that it cups the plunger and supports it in the drawn-out position; the syringe will brace against the flange on the plunger and the barrel <div style="border: 1px solid orange; padding: 5px; margin: 10px 0;"> <p>⚠ Bubbles will be coming out of the system through the oil into the syringe, drawn into the rarefied air. The rate of bubbles coming out should quickly start to reduce. If it is not happening, tighten the syringe to the refill adaptor and tighten the four cap screws.</p> </div> <ol style="list-style-type: none"> 3. Leave the syringe in this position for about an hour 4. Remove the kickstand, while keeping the syringe in place <div style="border: 1px solid orange; padding: 5px; margin: 10px 0;"> <p>⚠ The plunger will drop back, almost to the surface of the oil, due to low pressure inside the syringe.</p> </div> <ol style="list-style-type: none"> 5. With everything still attached, draw the plunger of the syringe just past the 10ml mark again 6. Very gently pump the plunger up and down approximately 10 times, until no bubbles come out of the system after drawing the plunger . 	
7	<p>Clean up and reassemble</p> <ol style="list-style-type: none"> 1. Remove the refill adaptor 2. Remove excess oil from the pressure port with a tissue or swab 3. Once cleaned, install the lower mesh insulator disk with the recess facing up 4. Place the nickel-copper mesh in the recess of the lower mesh insulator disk 5. Place the upper lower mesh insulator disk on top of the lower mesh insulator disk and nickel-copper mesh assembly 6. Open the split on the retaining ring and ease its middle into the sensor end-cap recession 7. Hold the retaining ring in place with one finger and feed the the rest of the ring into the sensor end-cap recession 	

8 External pressure adaptor

The external pressure adaptor is designed for the RBR*quartz*³ instruments and can be used to verify or recalibrate the Paroscientific Digiquartz[®] pressure sensor.

RBR provides the RBR*quartz*³ pressure adaptor kit with each instrument. It is not included in the RBR support kit and needs to be ordered separately. You can choose to receive this separate kit at the same time as the instrument, or to request it separately at a later date.

RBR*quartz*³ pressure adaptor kit includes:

- pressure adaptor
- four socket head cap screws
- 3mm and 5m hex keys
- five replacement O-rings



Pressure adaptor kit

Installing the adaptor

Step	Description	Image
1	Remove the antifouling mesh.	
2	Apply a thin layer of silicon compound to the O-ring.	
3	Install the O-ring into the O-ring groove of the external pressure adaptor.	
4	Position the external pressure adaptor over the exposed pressure port of the instrument.	
5	Install the four screws with a 5mm hex key and tighten them to 1/4 turn past snug (max 10 Nm torque).	

i Refer to [Removing the antifouling mesh assembly](#) for required materials and steps. Refer to [Replacing the O-rings](#) for additional instructions.

9 Repairs

RBR supports all our products. Contact us immediately at support@rbr-global.com or via the [RBR website](#) if there are any issues with your instrument. Please have the model and the serial number of the unit ready. Our support team will work to resolve the issue remotely. In some cases, you may have to return your instrument to RBR for further servicing.

 There are no user-repairable parts of the instrument. Any attempt to repair without prior authorisation from RBR will void the warranty. Refer to the [RBR warranty statement](#).

To return a product to RBR for an upgrade, repair, or calibration, please contact our [support team](#) to obtain a return merchandise authorisation code (RMA) and review the detailed shipping information on the [RBR website](#).

10 Revision history

Revision No.	Release date	Notes
A	31-March-2022	Initial release.
B	11-August-2023	Adjusted the introductory RBR <i>quartz</i> ³ BPR section for accuracy. Added guidance on horizontal deployment to the Orientation and datum location section. Added a warning to the Replacing the batteries section. Updated the Replacing the desiccant capsules section. Added a note about an earlier variant to the Pressure sensor maintenance section.
C	21-June-2024	Updated the RBR <i>quartz</i> ³ BPR interface subsection to include the MINK connector option. Added the Ethernet commands section. Added the Deployment section.
D	21-June-2024	Corrected a typo in the RBR <i>quartz</i> ³ BPR interface subsection.

